



INTRODUCTION AND USER GUIDE

DESIGN GUIDELINES AND TECHNICAL STANDARDS

VOLUME FY17, VERSION 1
May 1, 2017

CREATED AND MANAGED BY NAU FACILITY SERVICES

Table of Contents

Purpose of Design Guidelines and Technical Standards..... 3

Building Codes..... 4

 Building Code Variance Requests..... 4

Substitution to the Design Guidelines: Substitution Request 5

Updates 6

Important Information..... 7

DP & Contractor Acknowledgement..... 8

Design Guidelines..... 9

Technical Standards 9

Purpose of Design Guidelines and Technical Standards

The NAU Design Guidelines “DG” DG and Technical Standards “TS” (together “DGTS”) are viewed as one complete document, to be used complimentary and holistically. The DG highlights areas for programming and conceptual design, while the TS cover schematic design through construction documents, as well as products and execution. Design Professionals, Contractors, subcontractors and subconsultants are to be aware of all content within the DG and TS as there is important content that may affect a specific division that may appear in a different division.

The DGTS cover all NAU construction and renovation projects. They are intended to assist architects, engineers, other design professionals, contractors and university staff in understanding the preferences of University in the development, maintenance and repair of its facilities:

- Those persons at Northern Arizona University who manage projects, to assure that the standards and procedures outlined in this manual are implemented in the projects that are built on campus.
- Those persons involved with facilities on NAU Campus. Such persons can include, but are not limited to, administrators, user-groups, faculty, staff, trades-people, suppliers, vendors, University construction and maintenance shop personnel, etc.
- The Design Professionals, to use as their guide in preparing all necessary documents and submittals.
- The CM@R’s, General Contractors, Subcontractors, Suppliers, to use as a cross-reference with DP provided Specifications and as their guide in procuring all materials for the project. In case of conflict between these Design Guidelines and Technical Standards, these entities shall bring it up to NAU Project Manager for be evaluated with the Construction Project Team.
- The Design Professionals are advised to refer to those sections of the manual that relate to their projects and to adhere to its guidelines.

These Design Guidelines and Technical Standards are intended to create a common basis for the design, construction, maintenance, renovation and general care of facilities on NAU campus. The standards are the result of years of experience in designing, building, and operating facilities on the campuses, with a historical knowledge of what has served the University well. As such, they form the preference and knowledge base for all facilities on the campus. It should be clearly understood by all persons using these standards that they are not specification documents, nor are they procedures for construction. Design and document preparation continue to be the design professional’s responsibility. Means, methods, techniques, and procedures remain the Contractor’s responsibility.

These standards represent the preferred construction products, materials, details and systems to use in the development of programs, plans, specifications and construction documents. Components shall be selected through pre-qualification guidelines including, but not necessarily limited to, performance characteristics, code/regulatory compliance, maintenance control, and inventory standardization.

These standards represent the intent of the University to address the following primary criteria while providing optimal life cycle cost benefit to the University:

- Safety
- Reliability
- Maintainability
- Efficiency
- Sustainability

Building Codes

The requirements in this document do not supersede any applicable building codes. These requirements are in addition to all applicable codes, ordinances, statutes, regulations, and laws. If there is a conflict with any requirements in the design guidelines or in the Technical Standards, the more stringent applies.

Refer to Div. 1 Section 01 41 13 for all applicable codes adopted by Northern Arizona University.

Building Code Variance Requests

Requests for variance shall be evaluated by the NAU Fire Marshal (NAUFM) staff and NAU Building Official (NAUBO) staff, to ensure the proposed design, use, or operation satisfactorily complies with the intent of the IFC, IBC with related codes and NAU Technical Standards, as adopted by Northern Arizona University. The NAU Variance Requests Procedure can be found on the Facility Services website under the following link: ***(link is pending – please contact Project Manager for further assistance)***

Substitution to the Design Guidelines: Substitution Request

The Design Guidelines are a set of minimum requirements for design and construction at NAU. When these Design Guidelines and Technical Standards refer to a single manufacturer, it is not intended to exclude all other alternatives for all projects, proven to be equal or better, *unless specifically stated*. Design professionals and Contractors must adhere to the Design Guidelines and Technical Standards in all cases, however, the intent of these Design Guidelines and Technical Standards is *not to limit creative solutions*. In order to deviate from these Design Guidelines and Technical Standards, a written substitution authorization must be obtained from NAU.

Substitutions to the Design Guidelines and Technical Standards must be requested in writing by the Design Professionals to the NAU Project Manager.

NAU Project Manager must then obtain written approval for the substitution from Facilities Management (Director of Planning, Design & Construction), with recommendation from NAU Trades, as necessary. The University will consider requests for substitutions in order to provide the best benefit to the University and will typically require a life cycle cost analysis to be completed as part of the substitution process.

Written authorization shall be received prior to incorporation of the proposed substitution into the documents. The substitution must be made as early as possible but no later than completion of the design development phase.

Refer to Section 01 62 00 for Product/Material Substitution Form.

Updates

These Design Guidelines and Technical Standards are intended to be a continually evolving document. As new systems, components and techniques become available and they are deemed appropriate for use as a standard, they will be incorporated into these documents.

The technical content of this manual represents the culmination of input from many design, construction and maintenance professionals, included but not limited to NAU Trades Supervisors, NAU Project Managers and DP/CMARs who performed projects for the University in the past. Although it is felt that this effort produced a more up to date listing of NAU Technical Standards, it is realized that improvements are always possible and that many iterations may be required to achieve perfection.

To pursue this goal, please feel free to submit any recommendations for improvements via email to NAU, addressed to Stephanie.bauer@nau.edu.

This manual will be updated as requirements and procedures of NAU and the Arizona Board of Regents (ABOR) change.

Important Information

- Specifications are intended to be performance specifications which are not limited to a specific manufacturer's proprietary specifications, unless there is an approved sole-source waiver on file with Owner. Identification of material or equipment by manufacturer's name or trade name is not meant to give preference to any manufacturer but merely to establish a standard. In some cases, the specified product is required as it is used campus wide and is the only product stocked for repair and maintenance reasons.
- The following DG and TS criteria are to be adhered to at a minimum.
- The TS are created in the Construction Specification Institute (CSI) format. Any missing CSI divisions within the TS are due to a lack of specific content from the Owner. The DP team shall add missing content as needed for the project.
- There are defined terms throughout the Design Guidelines and Technical Standards. Defined terms may also be incorporated from the applicable construction agreements.
- DG cover primarily Programming and Conceptual Design, while TS cover Schematic through Construction
- These DGTS apply to Flagstaff Mountain Campus – Satellite campuses may conform to other standards. Consult with Owner for applicable standards for projects not occurring on the Mountain campus.
- The provisions of these standards and guidelines shall not be deemed to nullify any provisions of local, state or federal law. In the event that any part or provision of these guidelines is held to be illegal or void, this shall not have the effect of making void or illegal any of the other parts or provisions.
- Design Professional and/or Contractor shall notify Owner of any discrepancies within these *DGTS* or discrepancies between the *DGTS* and code or the Project Plans and Specifications. Discrepancies shall be resolved by Owner.

DP & Contractor Acknowledgement

Design Professional's and Contractor's acknowledgement of receiving NAU Design Guidelines and Technical Standards

On each project, the DP and the Contractor shall acknowledge receiving, reading and following NAU Design Guidelines and Technical Standards by completing and signing below.

In the event of a conflict between NAU Design Guidelines and NAU Technical Standards, please contact Owner for clarification on how to proceed with the design.

Project #: _____

Project Name: _____

DESIGN PROFESSIONAL:

Design Professional Firm: _____

Name of DP Signatory: _____

Signature: _____

Date: _____

GENERAL CONTRACTOR:

General Contractor Firm: _____

Name of DP Signatory: _____

Signature: _____

Date: _____

TO BE RETURNED TO OWNER PRIOR TO START OF DESIGN FOR DESIGN PROFESSIONALS AND PRE-CONSTRUCTION FOR CONTRACTORS. IF NO PRE-CONSTRUCTION PHASE, THEN PRIOR TO CONSTRUCTION FOR CONTRACTORS.

Design Guidelines

See separate Design Guidelines document.

Technical Standards

See separate Technical Standards documents, organized by CSI division.



DESIGN GUIDELINES

VOLUME FY17, VERSION 1
MAY 1, 2017

CREATED AND MANAGED BY NAU FACILITY SERVICES

TABLE OF CONTENTS

INTRODUCTION	3
PROJECT TEAM / STAKEHOLDERS	6
DESIGN GUIDELINES	10
1. CAMPUS MASTER PLAN AND ARCHITECTURAL DESIGN	10
2. PRE-CONSTRUCTION DESIGN DELIVERABLES	21
3. DRAWING LABELING AND FORMAT	22
4. BUILDING, FLOOR, AND ROOM NUMBERING GUIDELINES	25
5. STORM WATER DRAINAGE DESIGN & SURFACE WATER PROCEDURES	32
6. CAMPUS SUSTAINABILITY	42
7. CAMPUS METERING	57
8. CAMPUS ACCESSIBILITY AND UNIVERSAL DESIGN	58
9. ALL GENDER RESTROOM REQUIREMENTS	75
10. LACTATION ROOM REQUIREMENTS	77
11. CUSTODIAL PLANNING AND DESIGN	79
12. CLASSROOM AND OFFICE DESIGN GUIDELINES	82
13. LABORATORY PLANNING AND DESIGN	116
14. LANDSCAPE AND EXTERIORS	126
15. MECHANICAL, ELECTRICAL, AND PLUMBING DESIGN	129

INTRODUCTION

The Purpose of This Manual

Refer to the Introduction and User Guide for the Design Guidelines and Technical Standards for more information.

Advice to the Design Professionals

1. Ask Questions

Although the Design Professional (DP) team was chosen as best suited to the project, this may be the first project of this particular building type the DP team has undertaken at Northern Arizona University (NAU, Owner). Time spent in researching the goals NAU has in mind with the project, familiarity with campus infrastructures, how and why design was handled in a particular way on a similar project, and familiarity with the campus and user group structure prior to the beginning of architectural programming, will be invaluable to the design team. The Facility Services Project Manager assigned the responsibility to lead this project on behalf of NAU is your single point of contact for the project.

2. Communication Ground Rules & Documentation

- Under no circumstance should verbal approval be accepted or given. Any inquiry or direction that potentially affects project scope, budget, schedule or the Design Professional's compensation shall be made in writing and responded to in kind.
- Assume nothing. Assumptions made by DP team without written clarification in the form of letters, meeting minutes, sketches or written telephone conference logs will promote misdirection, miscommunications, design errors and subsequently lost time. It is the DP's responsibility to ask for and receive clarification, and have this information memorialized by way of a Project Authorization, before any work is to commence.
- Direction, approvals, clarifications, etc. that do not originate or go through the Project Manager, no matter what the lever or area, are not acceptable and are not binding, and will be at the expense of the DP.

All questions and communications regarding this project, the user group or the University must be coordinated through the Owner's Project Manager. This is the established project protocol, and will be further detailed to you by the Project Manager. It is the project manager's responsibility to answer, or direct the DP to those that can answer specific questions regarding any topic connected with the project in a timely and professional manner.

3. Contingencies

Some Design Professionals may be under the impression that project contingencies (design, construction and inflation) are for the use of design "extras". This is an erroneous and dangerous impression. Owner's contingencies are to be used at Owner's discretion.

4. Expectations

The Design Professional is required to be within the particular design phase budget, and if the project estimate at the completion of a particular phase indicates the design is over budget, the team will not gain the approval necessary to enter into the next phase. The team will then be required to expend the necessary time and effort to be within that budget, at the Design Professional's expense.

The further over budget the design is, the more time and effort will be required to bring the project within the budget. This is time that will not be compensated. It is therefore in the best interest of the Design Professional to obtain the highest degree of detail appropriate to all phases of design, to recognize all cost ramifications to particular design intent, and avoid promotion and pursuit of design elements that can neither be justified by the program nor afforded by the particular phase budget.

It is the Owner's expectation that by following the guidelines, procedures and advice as presented in this manual, the Design Professional will produce a design that not only meets program, budget and schedule, but also achieves a quality of design excellence.

There are principles of design that are thematic through the Design Guidelines and Technical Standards. It is advised and expected that Design Professionals consider these, as well as other industry standard design principles when working on NAU projects:

- a. Design Aligns with the Campus Context
Does the design of the space align with the campus master plan, academic master plan, landscape master plan, enterprise goals, and university mission? Does the design look like it belongs on the NAU campus, or does it stand out as different?
- b. Planning and Design Process
Ensure participation in the design process and build consensus and support with Owner's staff, which includes Facility Services personnel, as well as the user groups and other key stakeholders.
- c. Support and Operations
Consider not just the initial design and construction of a space, but also the follow-on support and maintenance required. The Technical Standards are an invaluable resource for design consideration of facility operations.
- d. Environmental Quality
Owner's spaces are heavily occupied, with some users spending long periods of time in the spaces. As such, they shall address human needs that go beyond the obvious components like technology and furniture. For example, consider the distractions of a

NORTHERN ARIZONA UNIVERSITY DESIGN GUIDELINES

room that is too cold, has flickering lights, or provides uncomfortable furniture that doesn't encourage collaborative work.

e. Layout and Furnishings

A successful space design anticipates not just what the occupants will be using but also how they will be using it. This includes considerations such as movement paths through the space, seating density, reconfigurability of the room, visibility of learning activities (if a classroom environment), and comfort of the furnishings.

f. Tools and Technology

Some technologies are foundational to a design, such as adequate electrical power or sufficient network capacity. It is critical to consider not simply how advanced technology is, but rather whether it is truly capable of supporting the anticipated activities for the space.

g. Innovation

NAU has specific design guidelines and technical standards, but innovation is still necessary. Think outside the box to solve design challenges and enhance a space's functionality.

h. Safety

Safety is paramount on a campus. Crime Prevention Through Environmental Design (CPTED) is a methodology that directly addresses the relationship between the physical environment and the incidence of crime. The following guide is a resource for understanding and using crime prevention through environmental design as a problem-solving tool: <http://www.popcenter.org/tools/pdfs/cpted.pdf>. Design Professionals must create a building design that inhibits people from self-harm (suicide prevention).

These principles are adapted from a 2015 Educause article by Malcolm Brown, located: <http://www.educause.edu/ero/article/seven-principles-classroom-design-learning-space-rating-system>.

PROJECT TEAM / STAKEHOLDERS

The NAU Facility Services Planning, Design and Construction (PDC) department manages Owner's projects. The Director of Planning, Design and Construction will assign a Project Manager responsible to manage each project. Several NAU Departments may also be involved in a project, with different roles and responsibilities. The Design Professional and the Contractor, along with Owner's Project Manager, shall ensure that all applicable Owner departments are consulted throughout the project.

Below are the different Owner departments that shall be involved in every project's design and construction, with a brief description of their responsibilities. These groups will participate in the Plan Review process prior to issuance of a Building Permit.

1. NAU FACILITY SERVICE PLANNING, DESIGN AND CONSTRUCTION GROUP

Owner Project Manager

The Project Manager, referred to as "NAU PM", "Owner PM", or simply "PM", guides each project from planning through project close out and warranty. The Owner PM works with the user groups, Facility Services Operations department (Trades), and Contractor to review the DP's work for compliance with program requirements, schedule, budget, and for conformance to required codes and NAU standards and procedures.

The Owner PM is the direct contact for the DP, Contractor, and other project consultants once the project has completed programming. After project programming is complete, all project work, information, and correspondence is directed to the Owner PM. The Owner PM is the liaison for the user group as well as other NAU departments. The Owner PM is also responsible for monitoring project activities during design and construction through occupancy.

The responsibilities of the PM include, but are not limited to, the following:

- a) Ensures the appropriate development and conformance of the project to the program, budget, schedule, and Design Guidelines and Technical Standards.
- b) Manages all meetings between NAU user groups, DP, and Contractor after project programming.
- c) Recommends approval of all payment to DP and Contractor.
- d) In conjunction with Owner's Contract Administrator, develops the contract for construction.
- e) Manages the negotiation for a Guaranteed Maximum Price (GMP) with Contractor, if applicable.
- f) Manages the construction contract.
- g) Evaluates the DP and Contractor performance for construction phase.
- h) Manages the entire project budget, including Contractor's fees, Design Professional's fees, additional vendors' fees, and Owner's contingencies.

- i) Manages warranty issues.

Administrative Staff

The PM is supported by administrative staff, including the contract administration staff, project assistant, and interns.

2. NAU FACILITY SERVICES UTILITY SERVICES

The Director of Utilities shall be consulted for:

- a. Location of existing utilities
- b. Location of point of connection for any new utility
- c. Coordination of any new utility layout
- d. Optimization of building orientation on proposed site based on energy modeling
- e. Review of proposed mechanical systems
- f. Review of all energy modeling
- g. Submittal to ACC (Arizona Corporation Commission) for Natural Gas scope of work

3. NAU FACILITY SERVICES OPERATIONS AND MAINTENANCE

Facility Services Operations and Maintenance is responsible for all NAU physical facility maintenance and operational activity, and therefore has a vested interest in the maintainability and long term of operational cost of every physical addition to the NAU campus. The Operations and Maintenance department is comprised of several subdepartments, known as “Trades”, which include: Electrical, Paint, HVAC, Building Access Services, Plumbing, Landscaping and Outdoor Services, Custodial, Carpentry, and others. These Trades are responsible for the inspection of construction work.

During the plan review process, Trades will assist in the plan review effort by asking questions and providing comments regarding longevity, maintenance requirements, accessibility of construction materials and building systems.

4. NAU FACILITY SERVICES ENGINEERING

NAU Plan Record/Vault

Facility Services has the responsibility to keep all documentation related to the University’s past projects, regardless of size and importance. All Construction Drawings, Specifications, RFI, ASI, Submittals, Shop Drawings, As-Built Drawings, Owner’s Manuals, etc... are kept on record at Facility Services. The documentation kept by NAU Facility Services is only as good as the documents provided to Owner at completion of a project. NAU encourages all DP and Contractors to be vigilant when it comes to the closeout process and ensure that complete and accurate documentation is provided for record keeping. Payment from Owner may be withheld until all documentation is received.

Building Officials

Facility Services includes in its organization the NAU Fire Marshal and the NAU Building Official, which is the Authority Having Jurisdiction, both in charge of verifying that all projects meet all applicable codes as adopted by Owner. Combined together, they have authority to perform plan review, issue construction permits, perform field inspections and issue the Certificate of Occupancy prior to the Substantial Completion Certificate is issued by NAU PM in conjunction with the DP.

The Owner issues construction permits and Certificates of Occupancy, depending on the scope and size of the project. Coordinate with Owner (Project Manager and Building Official) to confirm if this project will be subject to issuance of a construction permit and a Certificate of Occupancy.

5. NAU USER GROUPS

The NAU User Groups are those colleges, organizations or departments that will be the actual occupants or the direct beneficiaries of the project. User groups can be comprised of several colleges, organizations or departments, students, or a single uniform group. The User Group acts in an advisory and informational capacity to the Design Professional regarding programming/design function and space parameters.

6. NAU POLICE DEPARTMENT

This group must be consulted when a project affects any campus pedestrian or vehicular circulation and use patterns.

The responsibility of this department is to review the project for:

- a. Photometric levels at parking lots, parking structures and access paths to buildings.
- b. Security systems and reporting to NAU PD.
- c. Site design for safety, including camera locations, blue phone locations.
- d. Pedestrian and vehicular access, flow, density, direction on campus.
- e. Traffic study as applicable.
- f. Any proposed traffic changes, scope changes that might impact circulation on campus.
- g. Any proposed new or altered pedestrian crossways.
- h. Any proposed new street lights or street signs.
- i. Approval of the site logistic plan prior to start of construction.
- j. Traffic control plans during construction.

NAU PD shall review and sign-off on the site plan (from the DP) prior to design completion and site logistics plan (from the Contractor) prior to start of construction thru Owner's formal plan review process. The DP is responsible for submittals and incorporation of any comments received regarding the site plan. The Contractor is responsible submittals and incorporation of any comments received regarding the site logistics plan.

NORTHERN ARIZONA UNIVERSITY DESIGN GUIDELINES

Owner (Project Manager) may schedule a meeting with NAU PD and Fire Marshal to ensure that all emergency response parties are familiar with access to the construction site.

7. NAU PARKING & SHUTTLE SERVICES

This group must be consulted when a project affects any parking or bus routes on campus, either on a permanent or interim/temporary basis.

This group shall review and sign-off on the site plan prior to design completion and site logistics plan prior to start of construction thru NAU Facility Services formal plan review process.

The DP is responsible for submittals and incorporation of any comments received regarding the site plan. The Contractor is responsible submittals and incorporation of any comments received regarding the site logistics plan.

8. NAU EQUITY AND ACCESS OFFICE

Facility Services has signed a memo of understanding with the Commission for Disability Access and Design (CDAD). A CDAD representative will review the project for ADA Compliance. The DP is responsible for submittals and incorporation of any comments received during the design review.

9. NAU ITS AND TELECOMMUNICATIONS

Information Technology Services (ITS) and Telecommunication encompasses all voice and data communication and transmission design for NAU. ITS and Telecom reviews and assists all project design engineering regarding telecommunications and data for conformance with NAU standards. The DP is responsible for submittals and incorporation of any comments received. If required, this group will advise the DP in the design phases regarding NAU telecommunications and data interfacing, serviceability and maintenance. In regards to server rooms, for new construction or major renovations, DP shall not design new server rooms.

10. ARCHITECTURAL REVIEW

Content under development. Consult Owner (PM) for requirements on a per-project basis.

11. OTHERS

Every project is unique. Occasionally, there may be the need to involve other groups into the project team/stakeholders. This may include the City of Flagstaff, Coconino County, other ABOR institutions, etc.

DESIGN GUIDELINES

1. CAMPUS MASTER PLAN AND ARCHITECTURAL DESIGN

1.1. Overview

In 2010, NAU contracted with Ayers Saint Gross as the Design Professional to update the Campus Master Plan. The development of this Plan involved Owner's stakeholders, as well as the City of Flagstaff's community. It is expected that any Design Professional working for Owner will be familiar with the 2010 Campus Master Plan.

Northern Arizona University Campus Master Plan is available online:

http://nau.edu/uploadedFiles/Administrative/Finance_and_Administration/Facility_Services/Older_Templates/2010_MasterPlan.pdf

In 2015, NAU contracted with WLB Group as the Design Professional to prepare a Landscape Master Plan. It is expected that any Design professional working for Owner will be familiar with the 2015 Landscape Master Plan. It is available online at:

https://nau.edu/uploadedFiles/Administrative/Finance_and_Administration/Facility_Services/Documents/DP_Contract/2015%20Landscape%20Masterplan%20Final.pdf

1.2. Basis of Design

All structures are to be designed with a useful lifetime of 100 years. A low cost design approach in areas that cannot be "seen" undermines the philosophy of building at NAU, and in the end, is usually much more costly in maintenance and in remedial corrective action. Every effort should be taken by the DP to properly specify and detail masonry veneers, applications, joints and fastening systems to protect against moisture infiltration, efflorescence, cracking and the resulting excessive maintenance caused by improperly designed masonry wall systems.

1.3. Materials Palette

Brick masonry construction is the preferred method for a majority of buildings on campus. Brick will be selected during project design.

Masonry is a prominent part of the built environment at NAU. A materials palette was established for use for all new construction as part of the campus master planning. Materials included in the palette are the only materials allowed for use in the exterior of all new buildings and renovations. Brick, sandstone and stone veneer are the masonry elements described and shown in the master plan.

Glass block is specified for day lighting and insulated light transmission for open public space lighting and private or semi-private applications. In all cases, maximum translucency is desired but applications where modesty is required (such as restrooms) or in applications that benefit

from natural light without visual or physical noise (such as administrative offices), special glass block finishes are necessary.

Smooth faced block to transmit the most light and allow visibility is suggested for public spaces where privacy is not required. Design Professional should specify smooth clear faces that maximize solar collection and visual clarity or designs that do not compromise light transmission are preferred. Block that has a non-directional pattern or creates a distortion will provide the best privacy. Select a block that maximizes transmission and still provides privacy.

Reliance on "after-the-fact" material selections to compensate for a problematic design decision is unacceptable.

1.4. Thermal and Moisture Protection

1.4.1. General

The success or failure of the moisture protection concept is determined at the very outset of the design process.

The DP is expressly responsible for incorporating overall requirements into the project, and for ensuring that its sub-consultants are aware of the requirements and incorporate them into their designs as well. See Division 7 for more detail.

Building renovation design shall remove / relocate conduit, piping and equipment off the roof to limit roof penetration and obstructions.

The DP shall review the proposed roofing system early on (design development) with a considered manufacturer or installer of the system(s) for insights and suggestions that could alter the approach in mind.

1.4.2. Below Grade Spaces

Below grade spaces are high-risk, expensive designs. Wherever possible, avoid:

- The use of finished below grade spaces requiring drainage systems and wall waterproofing.
- Planters above or adjacent to basement areas

Owner actively discourages below grade elements in its projects. Designs incorporating below grade finished spaces will receive the strongest scrutiny during the programming and conceptual design phases. Be prepared to thoroughly document the unavoidable need for such elements.

Depending on the nature of the soil (refer to Soil Report), moisture contained under the slab, concrete mix design specified for slab-on-grade and type of flooring specified above slab, the DP shall analyze the need for an impermeable moisture barrier under slab-on-

grade and provide a written report presenting all findings and recommending which moisture prevention system should be used for the project.

1.4.3. Traffic Decks

Owner actively discourage use of traffic bearing decks in its projects. Designs incorporating horizontal traffic decks will receive the strongest scrutiny during the programming and conceptual design phases. Be prepared to thoroughly document the unavoidable need for such elements. Failing such documentation, the Design Professional will be directed to revise or even start completely anew the design.

Special attention should be given to ensure that all horizontal traffic surfaces provide appropriate slip resistance, and provide adequate moisture protection and drainage from its surface.

1.4.4. Roof Design

1.4.4.1. General

The DP shall coordinate with Owner's Project Manager and Trades to determine the appropriate roofing system based upon project budget and goals.

The following are the preferred roof systems:

- Sloped roof with standing seam metal roof
- Sloped roof with asphalt shingles
- Flat roof with thermoplastic membrane roofing

Any other roof systems will be subject to high scrutinizing scrutiny to ensure that the interest of the Owner in terms of Life Cycle Cost analysis, maintenance and longevity are achieved.

Any of the above roof systems should also shall incorporate sufficient insulation layers to provide an R-value to meet ASHRAE 189.1 standards, either below or above deck.

Do not design roofs which are intended to serve as walking surfaces for user functions. Activities which must be conducted on the roof top (e.g. astronomical or weather observations, greenhouses, etc.) will require a design which incorporates platforms, penthouses or similar special enclosures.

Similarly, do not design roofs which are required to be used as working platforms for maintenance of mechanical and electrical equipment. Enclose such elements in a penthouse.

NORTHERN ARIZONA UNIVERSITY DESIGN GUIDELINES

Any mechanical or electrical equipment which must be installed on the roof must be installed on either a prefabricated curb or a field fabricated platform. Where the top surface of such curbs and platforms is not completely covered and waterproofed by the actual equipment, the top surface must be a solid sheet metal cap. Design must meet OSHA workspace and fall precaution criteria.

Avoid use of conduit and piping installed on top of the roof.

No Electrical or Mechanical Equipment on the roof.

Combine roof penetrations (exhaust ducts) wherever possible to minimize roof penetrations.

Installation of any type of roof top mechanical or electrical equipment on sleepers is not acceptable.

Wherever possible, make the basic roof slope, and the slope of the crickets to the drains, part of the structural system (slope the structure). Avoid as much as possible thicknesses of roof insulation greater than 2" to create a roof slope.

By sloping the structure, it will be possible to eliminate use of lightweight concrete fill altogether.

Dead flat roofs are not acceptable.

Design for a slope of 1/4" per foot, throughout the field of the roof and for all crickets, at the time of construction. Ensure that anticipated deflections and proposed cambers will result in a minimum slope of 1/4" per foot throughout the life of the facility to guarantee positive drainage.

Space drains so that slopes in cricket valleys are at least 1/8" per foot.

Provide metal or 2x4 wood framing and sub-framing for large crickets. Cricket surfaces must be able to accept live loads similar to those of the basic roof deck.

Small cricket up-slope of equipment curbs must maintain 1/8" per foot slope in their valleys, and may be fabricated of tapered insulation, not to exceed 4" thick.

Do not assume that base flashings and counter flashing can be successfully nailed into concrete or masonry. Provide a 3/4" plywood nailer at all parapets.

NORTHERN ARIZONA UNIVERSITY DESIGN GUIDELINES

When possible, provide positive overflow drainage, preferably with a scupper through the parapet wall to daylight, or with a complete separate parallel overflow drain system daylighting.

Design all roof drains and overflow drains in a depressed sump.

1.4.4.2. Roofs and Snow

Roof design shall accommodate a snow load of minimum 40 lbs/sf.

Provide snow drifting analysis from a structural engineer to accommodate increased snow loads at areas where snow accumulation due to drifting might exceed the 40 lbs/sf of minimum required snow load.

Design roof and overhang to prevent formation of icicles. Provide protection for areas susceptible to icicle damage.

Roof drains should be design for the anticipated roof rain load. Design/calculations shall be done by the Design Professional to determine the size, location and quantities of roof drains.

Roof drains shall be provided with leaf screen at the top.

Design all roof drains and overflow in a depressed sump. Use #4 lead for roof drain sump pans.

Do not use exterior roof drains without the specific permission of Owner (both the Project Manager and Roofing department). Exterior roof drains should be at least 4 inches in diameter and shall have heat tape all the way down.

Interior roof drains are preferred, with heat tape down into the roof drain leader at least 3'-0" below roof. Installation of heat tapes at roof exposed to sun shall be evaluated on a case-by-case basis, with final determination in concurrence with Owner.

Gutter system should be seamless type 24 gauge minimum. Only non-corrosive fasteners, same material as metal being fastened. If straps are used, use #8 screws (min.).

Ensure that the design makes adequate allowance for proper flashing of perimeters and penetrations. Sufficient vertical dimension to install the cant strip, base flashing, counter flashing, and coping, will result in a parapet at

least 18" above the finished roof at the highest point of the roof slope. Include a specific detail in the construction documents. This includes:

- Parapet walls
- Partial roof structures
- Equipment curbs and platforms
- Door and window sills

1.4.4.3. Re-roofing

Design the project to allow for one complete re-roofing without removal of the existing roof system, should the Owner decide to do so. This includes:

- Structural load capacity
- Camber and deflection
- Parapet heights
- Joints, drains, and flashings

Re-roofing must comply with the requirements for new installations as much as possible. The DP is responsible for preparing complete details and specifications for the required reroofing work.

Roofing repairs (e.g. installation of a new exhaust fan), must comply with the requirements for new installations as much as possible. The DP is responsible for preparing complete details and specifications for the required repair work. Generic notes such as "flashing as required" are not acceptable.

On existing re-roofing project, verify if the existing flat area is asbestos containing and if so, it shall be removed from roof deck by Owner-appointed abatement contractor. The roofing contractor will be responsible for coordinating with Owner and abatement contractor to dry in all exposed area the same day.

1.4.5. Envelope Design (ASHRAE 189.1 Climate Zone 5 Recommendations)

All new Buildings shall be designed for LEED in accordance with the design contract, with an emphasis on building envelope efficiency to promote energy reduction.

In climate zones 2 through 8, as defined by the US Department of Agriculture, the recommended construction is standing-seam roofs with two layers of blanket insulation. The first layer is draped perpendicularly over the purlins with enough looseness to allow the second insulation layer to be laid above it, parallel to the purlins.

Through-fastened metal roofs are screwed directly to the purlins and have fasteners that are exposed to the elements. The fasteners have integrated neoprene washers under the heads to provide a weathertight seal. Thermal spacer blocks are not used with through-

NORTHERN ARIZONA UNIVERSITY DESIGN GUIDELINES

fastened roofs because they may diminish the structural load carrying capacity by “softening” the connection and restraint provided to the purlin by the metal roof panels. To meet the performance recommendations of this standard, through-fastened roofs will generally require insulation over the purlins in the conventional manner, with a second lay of insulation added to the system. The second layer of insulation can be placed either parallel to the purlins (on top of the first layer) or suspended below the purlins.

ASHRAE 189.1 Envelope Energy Efficiency / Thermal Performance Factors, see below:

Item	R-Value	U-Value
Roof Insulation	R-25 Continuous R-49 Attic	
Wall	R-13 Cavity + R-10 Cont.	
Fenestration Assembly		U-0.4 wood vinyl, Fiberglass frame U-0.4 Curtainwall U-0.45 Other Metal SHGC-0.35 (Solar Heat Gain Coefficient)
Overhang: Projection Factor = A/B	A=overhang B=opening height under overhang	

1.4.6. Dampproofing and waterproofing

Proper architectural design and detailing of areas exposed to moisture should not rely solely on such treatments as the only barrier to moisture, but rather as a "guarantee" or "second line of defense", in other words, the design and specification of appropriate materials should in itself greatly mitigate a majority of moisture infiltration problems.

The DP should review foreseeable methods and procedures relating to waterproofing materials early on (design development) with a considered manufacturer of the product(s) for insights and suggestions that could alter the approach in mind.

1.4.7. Thermal Insulation

This section applies to all constructed building vertical and horizontal surfaces that are thermal barriers to the environment and also inclusive of demising partitioning acting as acoustical barriers. Owner’s goal for all new and renovation projects is a substantial reduction in energy usage, both campus wide and building specific. All effort should be focused to mitigate thermal and acoustical factors through proper architectural design, detailing, orientation and adjacencies, and utilize applied insulating materials as a further enhancement to the composite performance of the design rather than the sole means of obtaining the desired performance.

Attics and other roofs include roofs with insulation that is entirely below (inside) the roof structure (attics and cathedral ceilings) and roofs with insulation both above and below the roof structure. If attic space is ventilated, provide tempered air and exhausting. Ventilated attic spaces need to have the insulation installed at the ceiling line. Unventilated attic spaces may have the insulation installed at the roof line. When suspended ceilings with removable ceiling tiles are used, the insulation needs to be installed at the roof line. For buildings with attic spaces, ventilation should be provided equal to 1 sq. ft. of open area per 100 sq. ft. of attic space. This will provide adequate ventilation as long as the openings are split between the bottom and top of the attic space. Additional ventilation can further improve the performance of the building. In accordance with ASHRAE Standards, Flagstaff is located in Climate Zone #5. In climate zones 2 through 8, the recommended construction is standing-seam roofs with two layers of blanket insulation. Where R-38 rigid insulation is provided, it shall be provided as 2 layers of blanket insulation held in place with steel banding spaced 30" o.c.

1.4.8. Exterior Insulation and Finish Systems

This section applies primarily to exterior insulation and finish systems that would be considered as the "secondary" skin treatment to a building, soffits, mechanical screen walls, infills, etc. The term "secondary" is used to refer to as Owner's desire for brick masonry to be used as the "primary" skin material.

Exterior insulation and finish system (EIFS) is a barrier exterior finish system that combines insulation qualities with a durable and aesthetically adaptable finish, but the main concern that has developed with EIFS is that water might get behind the barrier system and remain trapped.

When designing an EIFS, DP shall ensure that the materials selected and the wall section details will:

- Eliminate the possibility of water entry into the system;
- Provide an exit for water or moisture.

In Northern Arizona, where freeze/thaw cycles are very frequent, with high temperature differential between low and high, it is imperative to use materials with high flexibility that will not crack when submitted to the many temperature changes characteristic of the climate. Such system would be referred to as "modified" or "drainable" Exterior Insulated Stucco System. Specify primary products as produced and supplied from a single manufacturer, which has produced that product successfully for not less than 5 years.

Concrete masonry units are preferred as the backing material, however if budget and/or design considerations deem this inappropriate, fiberglass reinforced gypsum/Portland

NORTHERN ARIZONA UNIVERSITY DESIGN GUIDELINES

cement ("Dens Glass" panels, 3/4" thick, over structural steel studs, and with a waterproof membrane is an acceptable substrate).

Composite panels of expanded polystyrene with a minimum composite R value of 20 mechanically attached to the back-up system.

The composite finish system shall consist of heavy duty glass fiber reinforcing (adjacent to any area of pedestrian traffic, to a height of 8'-0" above finish floor), synthetic elastomeric primus layer, minimum 3/8" thick and a elastomeric synthetic finish layer, minimum 1/16" thick. Type PM System is highly preferred (Polymer Modified System, in which the mesh is mechanically attached to the foam and substrate). Use Type PB system (Polymer Base System, in which the mesh is adhesive, applied to the foam) only with specific permission of the Owner.

Consider alternative exterior cladding systems in areas where the finish may be subject to physical abuse. Indicate all required expansion, control, and design joints on the drawings. DP shall provide all flashing details and installation details on final construction documents.

NOTE: DP shall present a detailed system evaluation to Owner, including the Project Manager, Paint department, and Carpentry department.

1.4.9. Vapor Retarders

The building envelope is a key element of an energy-efficient design. Compromises in assembly performance are common and are caused by a variety of factors that can be easily avoided. Improper placement of insulation, improper sealing or lack of sealing around air barriers, incorrect or poorly performing glazing and fenestration systems, incorrect placement of shading devices, and misinterpretation of assembly details can compromise the energy performance of the building.

The building envelope should be designed and constructed with a continuous air barrier system to control air leakage into or out of the conditioned space. An air barrier system should also be provided for interior separations between conditioned space and space designed to maintain temperature or humidity levels that differ from those in the conditioned space by more than 50% of the difference between the conditioned space and design ambient conditions.

If possible, a blower door should be used to depressurize the building to find leaks in the infiltration barrier.

1.4.10. Fire and Smoke Protection

The use of spray applied fireproofing is prohibited unless all other methods of fire protection (above ceiling sprinkler systems, plaster enclosure, troweled application, etc.)

NORTHERN ARIZONA UNIVERSITY DESIGN GUIDELINES

are found to be unfeasible. DP must receive approval prior to the Design Development Phase Submittal.

Fireproofing systems which are part of a renovation project (e.g. repair of damaged or missing systems, or removal and replacement of existing systems) should follow these standards. Existing fire resistance ratings must not be compromised. The consultant DP must prepare a complete specification and details for the required repair work. Generic "repair fireproofing as required" notes are not acceptable.

1.4.11. Smoke Containment Barriers

Smoke containment barriers such as automated fire curtains are highly discouraged due to lack of reliability, frequent operating issues and higher maintenance requirements encountered on previous projects.

DP shall incorporate smoke containment barriers in the design in such ways that minimize the use of any moveable barriers.

The preferred smoke containment barriers is a solid wall (gypsum board on metal studs or masonry) with doors kept open using magnetic door holders tied to the fire alarm system.

1.4.12. Sealants and Caulking

Due to the Freeze/Thaw cycles in Northern Arizona, DP shall minimize the use of caulk joints in design.

Pay particular attention in sealant system design to expected joint movement, joint dimensions, sealant position (horizontal, vertical, or overhanging), and potential for physical abuse of the sealed joint.

1.5. Finishes

1.5.1. Tiling

Tile color and patterning should be clearly indicated by a sample and a colored sketch or plan and elevation at the final schematic design presentation.

1.5.2. Acoustical Ceilings

Careful design consideration should be given in the location of all lighting fixtures, diffusers or any other ceiling projection. Generally, office areas should be designed to accommodate an 8' ceiling height.

1.5.3. Flooring

Terrazzo is an extremely durable product and is recommended for design consideration in corridors, lobbies, and restrooms in heavily used facilities, budget permitting.

1.5.4. Wall Coverings

Application of Wall Coverings are discouraged because of difficulties in maintainability and repair when damaged. Wallpaper may be specified for some installations with Owner approval.

The DP shall submit a sample of color and texture of the proposed product at the final schematic design submittal.

1.6. Furnishings

1.6.1. Window Treatments

Window treatment is dictated by user preference and shall be determined, if applicable, during Design Development review meetings.

2. PRE-CONSTRUCTION DESIGN DELIVERABLES

Design Professionals are required to provide complete drawings and specifications sets to allow for minimum Requests for Information (RFI) during construction.

Contractors are expected to do a thorough review of these documents prior to construction for coordination purposes and to report any conflicts, incomplete information, etc., as well as to prevent last minute changes in the field during construction.

At a minimum, the Design Professional and the Contractor shall provide, during the Pre-Construction Phase, all documents listed in their contract agreement. Refer to Design Professional contract and its associated exhibits, for the specific deliverables applicable to the project. **The DP is to submit a Basis of Design (BOD) along with the program development submittal and an updated BOD at each subsequent design phase submittal.** An energy model and associated report and a total cost of ownership report is to be submitted when evaluating options for building orientation, architectural components and MEP systems. These reports will be used by Owner to select the building materials and systems. The energy model and reports shall be updated and submitted for each subsequent design phase submittal.

3. DRAWING LABELING AND FORMAT

The intent of these drawing numbering standards is to provide a set of documents that are consistent with the Owner's current needs and future construction, and are consistent from one project to another.

ELECTRONIC FILE FORMAT

- Facility documentation drawings and construction project drawings must be submitted to Owner in full compliance with AutoCAD software (file extension = .DWG)
- Owner will not accept any drawings in the Drawing Interchange Format (DXF) or any other format that .DWG. If any drawing translators are used prior to submittal, the results of such translation shall be 100% complete. It is the responsibility of the Design Professional to cross-check translated drawings for errors and omissions.

TEXT

- Text size must be legible and appropriate to the graphic information presented and the intended plotted scale of the drawing. Text must be in all upper case letters throughout the drawing.
- Text usually should not touch other graphic objects, and must be placed with enough space around it to be legible when the drawing is plotted and reproduced.

TITLE BLOCKS

The title block should be placed in paper scale, with its insertion point inserted at a coordinate location of (0, 0, 0), and at a scale of 1:1. Depending on the purpose of the drawing, whether it is for facility documentation or construction, the drawing's title block should contain certain essential information that Owner needs, to store and retrieve each drawing in its library.

Project Information

- Project Number - assigned by the Facility Services Planning, Design and Construction
- Project Name - assigned by the Facility Services Planning, Design and Construction
- Firm Name - representing the drawing author
- Building Name and Building Number - specify only if the project name does not include this information already, and the project is building specific.

Drawing Information

- Drawing Title - indicating the drawing content, e.g. floor plan, section, detail, etc.
- Facility Services Project Number – shall be referenced on all sheets
- Drawing Number
- Date of Drawing – original drawing date including significant revision dates

NORTHERN ARIZONA UNIVERSITY DESIGN GUIDELINES

- Drawing Scale – representing the intended plot of the drawing with title block
- North Arrow
- Electronic File Name and Effective Date

STANDARD SHEET SIZES AND FORMATS

All sheet sizes are to be limited to five standard formats. Required sheet size is specific to each project and is under the discretion of the University. They are as follows:

- A Sized Plot 8 1/2" x 11"
- B Sized Plot 11" x 17"
- D Sized Plot 24" x 36" (preferred format)
- E 1 Sized Plot 30" x 42"
- E Sized Plot 36" x 48"

CAD FILE TRANSMITTAL

The content of electronic drawings must match the delivered original hard copy set. To ensure the integrity of the electronic drawing set upon delivery:

- Ensure the drawings adhere to the guidelines presented in this document.
- Include a transmittal sheet (electronic and hard copy) with all submittals indicating the Owner's project number, project name and complete listing of all materials submitted, including file names and sheet numbers for each item included in the submittal. File names shall contain the sheet number they represent. This ensures the completeness of the drawing set and assists in archival procedures.
- Electronic data deliverables (.DWG and .PDF format) are required at all submittal stages.

CD-ROM LABELING

All CDs are to be labeled as follows:

- DATE – The date when the submittal was delivered to the campus for final acceptance.
- PROJECT – Title of the project name and project number.
- SUBMITTAL – Project submittal phase (i.e. 50% schematic, etc.).
- BLDG NUMBERS – Building number identified by the campus specific to the project.
- COMPANY – Name of design professional firm for the project.

SUBMITTAL REQUIREMENTS

- All submittal documentation forwarded to Owner shall be submitted in a timely fashion, coinciding with the needs of the project and the Facility Services Planning, Design and Construction Staff. The delivery of submittal documentation during

NORTHERN ARIZONA UNIVERSITY DESIGN GUIDELINES

various stages shall be timed appropriately to ensure Owner receives the most accurate information available.

- Ensure the Owner's project number is located on all drawing sheets (including the cover sheet) and all other submitted documentation, i.e. Specifications and Operations and Maintenance Manuals. The Owner's project number should be located in the title block of all drawings, and in the header or footer of Specifications and Operations and Maintenance Manuals, and any other submitted items.

VALIDATION OF DELIVERED MATERIALS

- Owner will validate the CAD data and other materials submitted by Design Professional. If submittals do not conform to the Owner's Drawing Numbering Standard Guidelines, Owner may return the materials to the Design Professional. The Design Professional is responsible for revising the materials to make them conform to the Owner's Drawing Numbering Standard Guidelines.

4. BUILDING, FLOOR, AND ROOM NUMBERING GUIDELINES

4.1. Overview

These guidelines will allow floor, room numbering, and way-finding procedures to be applied consistently to all of Owner's buildings.

For new buildings, these standards should be explicitly followed. In cases of renovation or additions to existing buildings, the building's existing numbering system may be extended, or abandoned in order to use the following standards to renumber the entire building including the renovated and/or added space.

The intention is for each facility's floor and room numbering scheme to be structured so that the numbers flow through the building in a consistent, comprehensible, and user-friendly pattern. The scheme should be clear to the users of the facility, not causing confusion for individuals attempting to locate spaces.

All drawings issued for construction shall contain accepted room numbers so that all affected equipment including but not limited to doors, electrical panels, telephone backboards, air distribution devices, as-built information, and air balance reports will not have to be cross-referenced or revised during construction or after occupancy of the space.

Room numbers affect several agencies including emergency responders, multiple campus databases, chemical inventories, maintenance, and telecommunication systems; because of this room numbers are not to be changed without a formal review process by Owner's Space Management department.

4.2. PROCESS

4.2.1. Building Numbering

The Owner's Office of Space Management will assign new building numbers with the approval of Facility Services.

4.2.2. Floor Numbering

4.2.2.1. Floors

Floors are numbered using a 1-digit standard starting with '1' for the first floor and continuing up for every floor above. The first character of a room number indicates the floor level of the building. The level with a "1" as the first character should be the uppermost floor entered at grade or one half flights above grade. Levels below this can use the character "B" (basement). Buildings located on steeply sloping sites may need to vary from this rule; where

necessary, the floor numbered “1” may not in fact be the uppermost floor entered at grade.

4.2.2.2. Mezzanines

Large mezzanines shall be numbered as a whole floor. Example: When a mezzanine exists between the first floor and the next whole floor, it will be numbered as the second floor.

A mezzanine is defined as a partial floor located between structural floors.

4.2.2.3. Attics and Roof Levels

Usable attic floors and penthouse levels should be numbered as if they are whole floors. For example, a two-story penthouse atop a three floor building will be numbered as the fourth and fifth floors. Do not use prefixes such as “R” for roof level.

4.2.3. Room Numbering

4.2.3.1. General

Use 3 or 4 digit numbers (plus optional alpha prefix or suffix) consistently throughout the building.

4.2.3.1.1 Three digit numbers shall be used for rooms with assignable or public space. The first digit shall indicate the floor number, for example: first floor will be numbered 100’s; second floor will be 200’s; third floor will be 300’s etc. Ground floor or basement rooms will be numbered as B01, B02, etc. When rooms open off of another room and not from a corridor (such as in a suite of offices), use the number of the first room with a letter suffix (example: Reception 301, Office 301A, Office 301B, Office Storage 301C). Rooms in a designated wing shall have an alpha prefix specific to the wing (example: A112A, B112A)

4.2.3.1.2 Four digit numbers shall be used for non-public rooms. Number shall be as a suffix to the 100 level to describe restrooms, electrical and mechanical rooms, elevator control rooms, custodial closets or enclosed stairwells. (Example: 1001, 1002, 1003)

4.2.3.1.3 Rooms with specific uses and unique spaces may be designated by their room type followed by a number or an alpha numeral per the building user’s request (i.e. “Studio A”). These designations shall be determined in schematic design if possible.

NORTHERN ARIZONA UNIVERSITY DESIGN GUIDELINES

4.2.3.1.4 Cubicles should have their distinct room number. Each cubicle within the row is designated using a singular room number followed with a letter. Letters are in alpha order from the main corridor. See Figure 1

Figure 1

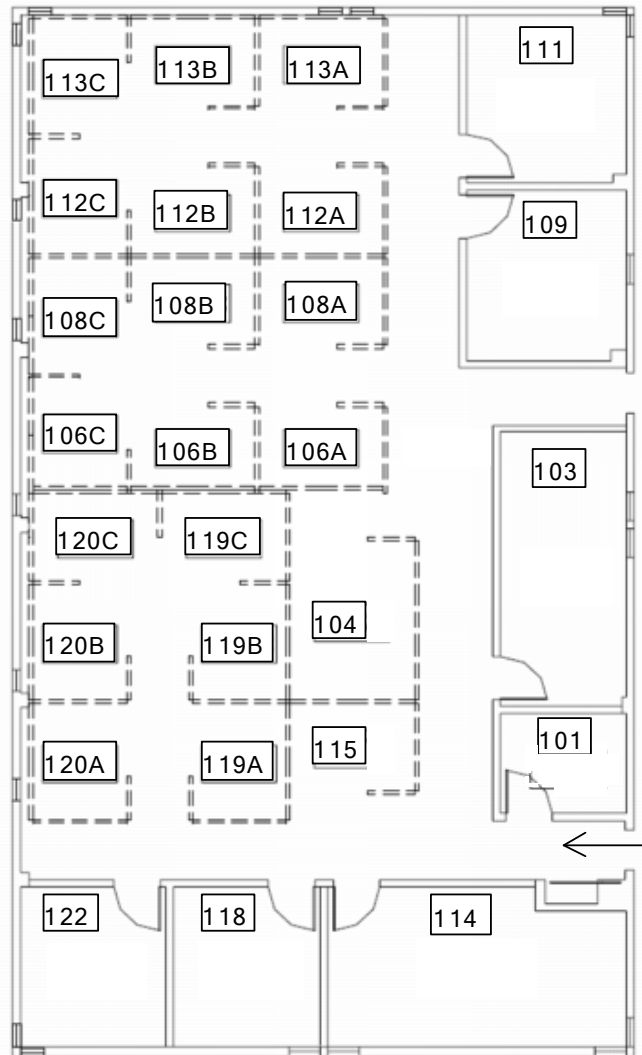

4.2.3.2. Number flow

Numbers should flow from one end of the building to the other. In a building with only one dividing corridor, room numbers should flow in ascending order from one end of the building to the other. In a building with a more complex corridor system, numbers should flow in ascending order in a counterclockwise fashion, from right to left, through the corridors from the main entrance, or similar location such as elevator lobby. Any doors that face the Lobby or entry point should be numbered in the beginning sequence.

4.2.3.3. Odd vs. Even

Use odd numbers on one side of a corridor and even numbers on the other side. Room numbers shall be coordinated so that even numbers are on one side of a corridor and odd numbers are on the other side. See Figure 2. In more complex designs, or where the availability of numbers is limited, the odd-even format can be abandoned if consecutive numbering results in a more logical scheme.

Figure 2



4.2.3.4. Skip numbers to maintain succession of room numbering

In some instances, room numbers on one side of a corridor shall be skipped in order to maintain succession with the room numbers on the opposite side of the corridor. This may occur, for example, when a suite of rooms or large space is accessed through a single door and there are no other doors on that same side until further down the corridor. This will allow for future renovations that may convert suites or large spaces into separate or small rooms with a corridor door. See Figure 2.

4.2.3.5. Skip numbers to allow for future renovations

When a corridor contains large rooms such as classrooms, meeting rooms, etc. on both sides of the corridor, room numbers shall be skipped to allow for future renovation of a large space into smaller spaces. Sufficient numbers shall be reserved to allow for the large spaces to be divided into standard size office spaces. See Figure 2.

4.2.3.6. Use similar numbering on each floor

An effort shall be made to maintain consistent room numbers for similar elements on each floor (i.e. for restrooms occurring in the same location on

each floor use a common room number format and the same ending digits). See Figure 3

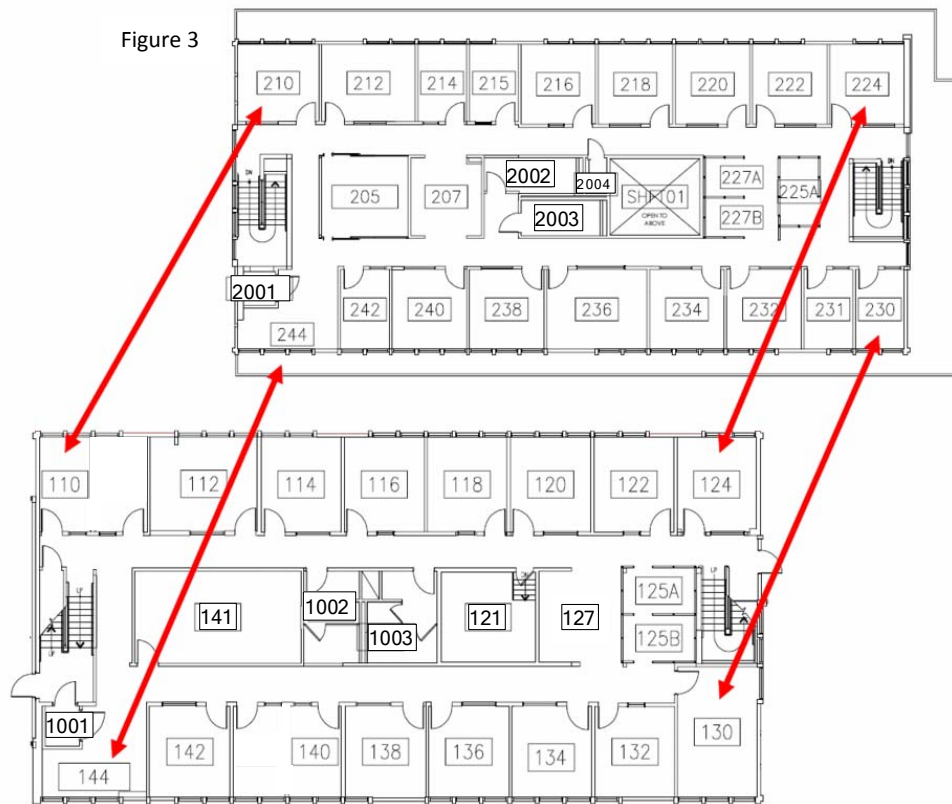

4.2.3.7. 4.2.3.7 Alphabetic Suffixes

Use alphabetic suffixes for rooms entered from other rooms (rather than a hallway). Rooms entered from a main corridor or lobby is numbered with no letter suffix. When rooms open off of another room and not from a corridor (such as in a suite of offices), use the number of the first room with a letter suffix (example: Reception 301, Office 301A, Office 301B, and Office Storage 301C). See figure 4. Assign suffix letters in the order rooms are encountered and, where possible, in the same direction as the overall numbering sequence. Only a single suffix is allowed; thus in the case where the first room already has a suffix, the next alphabetic designation shall be used. Avoid the letters “I” and “O” which may be interpreted as numbers. Large suites with many rooms can use non-suffixed numbers if it makes the numbering scheme more understandable.

Figure 4

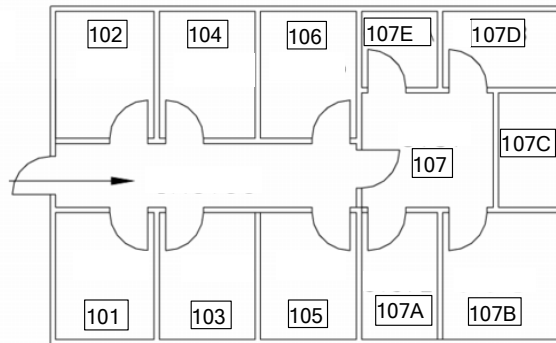

4.2.3.8. Each room should have only one number

Each room should have only one number regardless of the number of doors opening into it. Exceptions can be made where a particularly large room is subdivided into different areas of use, such as by cubicles. In these cases, one-character letter suffixes are added to create unique numbers. Where the number of areas exceeds the suffixes available, additional sequential numbers should be used.

4.2.3.9. Number all accessible spaces

In addition to rooms, all interior spaces that can be directly accessed, such as corridors, vestibules, stairwells, elevator shafts, and accessible pipe spaces shall be numbered in a manner as consistent as possible with standard room spaces. Where doors or walls separate different areas of these spaces, each area shall receive its own unique number.

4.2.3.10. Public Circulation

In a building with only one dividing corridor, public circulation numbering should flow in ascending order from one end of the building to the other. In a building with a more complex corridor system, numbers should flow in ascending order in a counterclockwise fashion, from right to left, through the corridors from the main entrance, or similar location such as elevator lobby. Numbering should begin with the floor number followed by 00 and an alpha character. (Example: 100A, 100B, 200A, 200B)

4.2.3.11. Standards for Parking Decks

Standalone parking decks are considered buildings and will have a building number and room numbers to cover all usable space within the structure. This also includes the top uncovered level.

NORTHERN ARIZONA UNIVERSITY DESIGN GUIDELINES

4.2.3.12. Conflicts and Special Cases

In the case of conflicts or questions, Owner’s Space Management department should be consulted and will provide a room numbering scheme to be used.

Existing building as of December 31, 2013 have numbering systems established at the time of construction. All new construction starting January 1, 2014 must adhere to the new guidelines.

Appendix A: Room Numbering Guidelines

Room Number	Formula	Example	Brief Description
Typical Rooms	Room Number	101,112,224	Group of rooms that are entered from a corridor
Suites and Sub-Rooms	Room Number + Letter	101A, 134A, 134B	Group of rooms that can be entered from a main “lobby” like space
Rooms within Sub-Rooms	Room Number + Letter + Letter	104AA, 245AA, 245AB, 245AC	Typically small closets within a sub-room
Wings	Letter + Room Number	A101, B101	Unique leading letter assigned to all rooms within a wing
Cubicles	Room Number + Letter	101A, 112A	Assigned distinct number grouping and in alpha order from main corridor
Building Common Areas	4 digit room number	1001, 2001, 3002	Numbers assigned in areas such as; Mechanical, Electrical, Janitorial, and Restrooms
Circulation	Floor Number + 00 + Letter	100A, 100B, 100C	Assigned to public circulation areas that are not independent rooms

5. STORM WATER DRAINAGE DESIGN & SURFACE WATER PROCEDURES

5.1. DESIGN INTENT

The goal is to provide the structures necessary to make use of storm water through harvesting; and infiltrating water, keeping water onsite wherever possible.

Storm water drainage management also includes the LEED goals of water collection and onsite reuse. The entire project area needs to be considered for opportunities to collect and store storm water for irrigation. These features must also be designed to withstand the stress of freezing and thawing that are a reality on the Flagstaff mountain campus.

Within a project's design process, managing the storm water drainage is a key part of the integrated site design promoting proactive solutions that are consistent with or exceed regulatory standards. Given current limited storm drain and land capacities, some of the mitigation of past and future storm water drainage issues at Northern Arizona University should occur on a project by project basis.

Project designs shall include retention and infiltration facilities to contain the first inch of precipitation at a minimum. Additional retention may be added to address problems elsewhere on campus. The Design Professional is to consult with the Owner (Director of Utilities) for guidance on providing retention on a site by site basis.

Ways to store and reuse storm water may include such elements as mini-retention basins or large retention basin, designed as landscaped areas to promote students gathering and shall not include any concrete.

5.2. GENERAL STORM WATER GUIDELINES

5.2.1. General

Preliminary siting studies for the project shall consider information related to the existing drainage conditions of the site, using the most recent campus-wide drainage study as a reference. The preliminary siting studies shall consider, at a minimum:

- The existing site area and adjacent areas within 500 feet of the project, and include all areas which may contribute storm water (watershed) to the proposed site.
- The general area where the site is located, for example, the campus historical core, north campus, south campus, etc.
- Evaluation of existing landscapes, plant palette, formal, informal, historic, ornamental and introduced plants.
- Evaluation of the contextual setting of the site.
- Utility (below/at grade) corridors, emergency routes, pedestrian and automobile core circulation routes.

NORTHERN ARIZONA UNIVERSITY DESIGN GUIDELINES

- Identified project building expansion and proposed expansion adjacent to the project site.
- Evaluation of adjacent facility parking, vehicular and service accesses.
- Whenever possible, site development should not diminish the quality or increase the quantity or rate of storm water drainage flow that leaves the site in its existing condition. Potential increased storm water drainage flows should be mitigated on-site if possible.
- Downstream conveyance impacts must be evaluated and mitigated to prevent the hazards associated with overflows, pounding and ice formation.
- Wherever possible, site development should include strategies such that the storm water flow does not diminish in quality or increase in quantity when compared to the level of the original natural condition of the site. This can be achieved through the use of landscape features and water harvesting.
- Opportunities for water harvesting should be specifically discussed in conceptual narratives in early design stages. **“The City of Flagstaff Low Impact Development: Guidance Manual for Site Design and Implementation, 2009”** should be used for the design basis. (<http://www.flagstaffstormwater.com/index.aspx?NID=8>).
- Site development should meet or exceed all applicable regulatory standards. The intent is to meet at a minimum the current City of Flagstaff storm water drainage standards and exceed them where possible, and to demonstrate innovative techniques for which the City of Flagstaff may not have applicable standards.
- Retention of storm water: the conveyance and retention capacity shall be sufficient to collect and store the first inch of precipitation that falls onsite for a typical rainstorm.
- Plans will incorporate: conservation of natural areas, minimizing disturbance of natural drainages, minimizing and disconnecting impervious surfaces, and minimizing soil compaction. Many of these points require consideration of construction methods, site access and control of the site areas that are not intended for development, during construction.
- All project sites shall include areas designed to collect and infiltrate water which may include swales, buffer strips, porous pavements, bio-retention, sedimentation and extended detention basin designs.
- Provide a Storm Water Drainage Report. This report, to be prepared for each project will be based on the format and technical standards of the City of Flagstaff Engineer’s Design Report.
- Wherever possible, site development should occur such that all flows exiting the project site remain in the current watershed sub-basin so as to not impact drainage patterns in adjacent watershed sub-basins.
- Flood Prevention: Proposed building ground floor elevations and any apertures into the building should be 1’ or more above the 100 year flood plain. Sunken access ways or patios leading to building levels below the natural grade of the site are not permitted when adjacent to a 100-year floodplain, and discouraged in other areas. Soil should be graded so that water drains away from the building at a minimum of

NORTHERN ARIZONA UNIVERSITY DESIGN GUIDELINES

2%, subject to other site criteria, such as accessibility. Elevations of underground utilities shall be considered in the grading layout.

Site development must be done in a way to avoid the following conditions:

- Ponding of a duration that may allow mosquito breeding, in access ways which may create a nuisance for pedestrians, or within 10' of building foundations (to prevent infiltration that may cause indoor mold or structural problems).
- Any water catchment not draining within 24 hours
- Retention (groundwater infiltration) facilities not draining within 12 hours.
- Surface water that is wasted, e.g., by running down the street.
- Surface water that is routed in a way which inappropriately distributes sediment or chemicals.
- Channelized or concentrated water conveyed over sidewalks
- Water running off of irrigated turf areas.
- Water that puddles in areas where freezing may cause a pedestrian or vehicular hazard or damage to hardscape.

5.2.2. STORM WATER POLLUTION PREVENTION PLAN (SWPPP)

- All projects will have a Storm Water Pollution Prevention Plan (SWPPP) no matter what their acreage. If a project is less than one acre of disturbed area, an Arizona Pollutant Discharge Elimination System (AZPDES) permitting will not be necessary. On all projects, best management practices shall be followed by the contractors to ensure that existing storm water drainage systems are not polluted during construction.
- If one acre or more is disturbed an Environmental Protection Agency AZPDES Storm Water Construction General Permit must be secured. The Northern Arizona University Office of Regulatory Compliance may be contacted (<http://www.orc.nau.edu/>) for guidance in securing this permit and filing the associated EPA Notice of Intent (NOI). A copy of the permit shall be provided to NAU Office of Regulatory Compliance and NAU Facility Services Project Manager prior to any construction work on site. A copy of the SWPPP Guidance Checklist can be found at: <http://www.azdeq.gov/environ/water/permits/download/cswppp.pdf>.
- All SWPPPs shall be prepared by the Civil Engineer of record.
- The Contractor shall secure permits with Arizona Department of Environmental Quality.

5.2.3. STORM DRAIN DISCHARGES

- Water discharged (e.g., storm water drainage, condensate) from sources that must be pumped to a location for conveyance/disposal should not be directed to roadways/hardscape. Such discharges should be directed to

NORTHERN ARIZONA UNIVERSITY DESIGN GUIDELINES

planted areas except when the water quality would be detrimental to plants.

- Storm water drainage shall not be directed into the sewer collection system. Use of the sewer system in this way is considered a prohibited discharge by City of Flagstaff.
- Sewer manholes are not allowed in low lying areas and/or known watercourses to prevent waters from infiltrating through perforations in the manhole cover.

5.2.4. ROOF DRAINAGE

- Roof drainage outlets and landscape surface materials must be designed to prevent landscape erosion.
- Ponding within 10' of the building edge is prohibited.
- Roof leaders/scuppers should be of a small enough diameter so as to divide roof runoff into a series of outlets with a low enough volume/velocity that will allow water to be harvested equally throughout the site (i.e., broken into small volumes for smaller basins/swales). Large diameter outlet pipes convey too much water at too high velocity to capture in small-scale landscape swales. Proper clean outs should be provided to allow necessary maintenance of smaller diameter pipes.
- Roof Drain pipes are prone to freezing during the winter.
- Roof drainages should flow freely even under freezing conditions, new construction shall include interior or insulated and heated roof drains with temp sensor switches to prevent warm weather operation. Renovations of roofing where roof drains are a problem will include correction of the problem through similar design solutions.
- Depending on the project site, the Design Professional should review with Owner the strategies to drain the roof (day-lighting versus tie-in to storm water drainage underground).

5.2.5. ANCILLARY WATER SOURCES AVAILABLE ON OR NEAR SITE

- Water sources such as mechanical condensate, process water, gray water, drinking fountain water, and other sources identified shall be considered as part of passive and active water harvesting systems.
- Such water may be used, if deemed appropriate, for landscape irrigation, return to central plant for other uses, supplementing water for pools or water features, or other uses to be determined.

5.2.6. SOILS

- Site soils need special consideration during the design process for effective use of Low Impact Development (LID) technologies.

5.2.7. PLANNING

- Soils evaluation should begin with planning for site areas where soils are to be used for structural and vegetative support and for water collection and infiltration. Areas considered for infiltration should be evaluated for soil characteristics especially percolation rates, prior to designating these areas for natural infiltration. If soils are suitable, these areas need special planning and protection because construction activities will change the nature of the soils and potentially destroy their useful characteristics.
- Site planning for soil protection should be treated with the same level of attention as protection of existing vegetation and provision of structurally appropriate soils for building support. Soils that are to be used in the final LID structures or in landscaping must be protected from contamination and compaction by construction equipment. Evaluation of the trade-offs between removal and replacement of soils, gravels and non-structural earth and protection of this resource onsite shall be part of the design.
- Cost effectiveness of different solutions should be evaluated and presented as part of the design effort.

5.2.8. TESTING

- If possible, soils testing should be conducted at the time of or prior to preparation of the initial draft of the Storm Water Drainage Report that will be prepared for a project. Such reports should investigate not only structural characteristics but also percolation rates.
- A soil percolation test is required after rough grading of major/regulatory detention and retention facilities to verify that site development activities have not negatively impacted percolation rates. If reduction in percolation rate is identified, mitigation may be required.

5.2.9. SUBSURFACE PREPARATION

- Structural soils should be explored for use under large expanses of hardscape or other areas with limited percolation.
- Soils beneath/adjacent to French drains, and other sub-surface structures should be over-excavated and replaced with an engineered soil designed to absorb or accept water.

5.2.10. COMPACTION

- Soil beneath the bottom of all water harvesting areas should be loosened to a depth of at least 18" prior to trenching and installation of irrigation lines.
- Specified compaction required for buildings, streets, and other structures shall be maintained within specified distances around such structures.

NORTHERN ARIZONA UNIVERSITY DESIGN GUIDELINES

Beyond these compaction zones, soil should be loosened to a depth of at least 12" prior to planting within all landscaped areas.

- All construction debris and waste material must be removed from the soil within landscape and basin areas.
- Once compaction is achieved and completed, soils should not be disturbed as to not affect soil compaction.
- Acceptable limits of compaction must be maintained through completion.

5.2.11. SOIL GRADING

- The finished grade of all landscaped areas that are designed for use as catchments should be recessed downward from adjacent paved surfaces. Maximum reveal at edge of pedestrian circulation paving shall be 1/2" to minimize the risk of injury. Shoulders are to be consistent with the landscaping portion of Division 32 00 00 Northern Arizona University Technical Standards.

5.2.12. GROUND COVER MATERIALS

- All materials shall be consistent with landscaping standards 32 90 00 and approved for use by Owner.
- Within areas conveying significant storm flows, ground surfacing should consist of a material that is able to withstand scouring. This includes hardscape paving, rock mulch, graded or sized rock, riprap, fractured rock, and turf in some situations. Bare soil, decomposed granite, or other loose forms of mulch are not suitable for this application. Filter fabric placed with 12" minimum toe downs at edges shall be used under all rock, mulch, and riprap within conveyance areas.
- Fine grades of decomposed granite should not be used within or adjacent to basins or water harvesting areas. Landscape areas which shed water rather than capture it should receive ½"+ crushed gravel with no fines, preferably with a mixture of sizes and some color variation to reflect the native desert surface.
- The bottoms of landscaped basins should receive ¼" pea gravel or ½"-1" sized/graded crushed rock that has been washed to remove all fines or organic mulch.
- Colors samples of all proposed rock types shall be submitted for approval.
- Organic mulch is encouraged in locations where the vegetation, water collection, erosion, and slope characteristics make it appropriate.
- Turf, as a surface material in large regulatory basins, is only permissible when combined with a low-flow landscaped area which allows a majority of the turf to drain within a short time. It is preferable to utilize turf predominantly on the bottom rather than sides of large basins for ease of irrigation and mowing and to allow the turf to be watered by sheet-flow

NORTHERN ARIZONA UNIVERSITY DESIGN GUIDELINES

runoff. Based on project-specific considerations, turf panels may include a shallow retention catchment (6" or less) which shall include a prepared soil bed that will rapidly absorb retained rainfall. Extensive subsurface soil preparation will be required for turf in basins which collect greater volumes.

5.2.13. RIP-RAP

- Where required, utilize rough, non-angular, owner approved stone (samples should be provided by Contractor for size verification by Design Professional).
- Filter fabric should be included under riprap used for erosion protection in a conveyance channel, and any gaps in riprap shall be fully filled with pea gravel or sized/graded rock that is swept in the gaps to prevent erosion.
- Rip-rap to be sized per City of Flagstaff Storm Water Management Manual and Design Professional shall include calculation in report.

5.3. SNOW MANAGEMENT

In all designs and site planning, snow management must be considered and provided as follows:

- Parking areas need to allow for efficient snow removal operations and include appropriate turning radii for snow plows and heavy equipment.
- Snow storage areas adequate for a typical winter storm (2 feet of snow in 24 hours) shall be included in parking lot design.
- Snow melt drainage from the storage areas and for areas around the building will be designed with special consideration for access to snow melt drainage conveyances for maintenance activities as needed.
- Evaluation and design of areas that are prone to collect snow or ice with special attention to the areas on the north side of buildings and structures where refreezing of melted snow or ice causes hazardous conditions to pedestrian and maintenance vehicle traffic.
- Evaluation of snow melt and melt storage shall include coordination with Owner to determine if deicing materials or chemicals are being used on snow and ice and if runoff will need special handling to prevent damage to landscaping through use of the water or clogging of infiltration systems by cinder fines or other materials.

5.4. STORMWATER EVALUATION PROCEDURES

Depending on the nature of the project and site, an independent Storm Water Drainage study (as a precursor to the Storm Water Drainage Report described below) may be required and completed prior to the start of the project for the purpose of understanding site issues, budgeting, or other needs. Facility Services will determine if an independent study is required and contract for this initial work if necessary. This independent study could be part of the programming and sustainability evaluation.

5.4.1. Project Design Process

The Design Professional's scope of work will require compliance with the storm water drainage standards found above. As a result of project-specific design guidelines identified in the independent storm water drainage study, storm water requirements may be developed which call for unique conveyance features or other special requirements.

The project design should be informed by project-specific site development guidelines, The Northern Arizona University Design Guidelines and Technical Standards, site soils tests, and other regulatory considerations. For projects located in south campus, review the *NAU Assessment of South Campus Storm Drainage*. These resources shall guide the preparation of a Storm Water Drainage Report and design solutions, as required in the project scope of work and described below.

The Northern Arizona University Director of Utilities is available to the Design Professional throughout the project to review these standards and guidelines and to discuss and provide guidance on detailed storm water drainage design solutions.

The Design Professional is responsible for ensuring that all applicable sub-consultants understand the studies, plan sets, details, and specifications each sub-consultant will need to prepare in order to meet these standards. Sub-consultant fees should appropriately reflect the work necessary to meet these standards.

During the first design stage where site development concepts are being investigated there should be a demonstration of how existing drainage impacts the site along with conceptual options for how storm water drainage may become an integral part of the project design. At each subsequent plan review phase the submittal set shall include designed storm water drainage elements which are responsive to the Concepts and Mitigation section of the Storm Water Drainage Report described below and are developed to a level of design commensurate with the rest of the project.

Appropriate soils tests will be completed as early in the design process as possible to inform the final storm water drainage design solutions. These tests shall include measures needed to understand the suitability of the soil for the infiltration needed for retention/detention, in addition to structural and other characteristics as described in Sections above.

5.4.2. Storm Water Drainage Report

During the first design stage where site development concepts are being investigated, a draft Storm Water drainage Report will be prepared by the Design Professional. The report will have two main components: an Existing Conditions Analysis section, and a Concepts and Mitigation section.

5.4.2.1 Existing Conditions Analysis: this report section analyzes and documents existing storm water drainage conditions on the project site. The form and methods used for this report should conform in general to City of Flagstaff standards, e.g., use the format of the City of Flagstaff Storm Water Management Design Manual to create a Drainage Report.

South Campus technical analyses shall be built on the *NAU Assessment of South Campus Storm Drainage*.

5.4.2.2 Concepts and Mitigation: each subsequent draft of this report section should include increasing specificity and technical documentation on proposed storm water drainage features and mitigation which emerge from the initial vision/concepts. This report section shall include, at a minimum, the following two elements:

- Storm water drainage vision and concepts for the project, presented in narrative and graphic form, conveying how storm water drainage may be incorporated in the project design. Include specific concepts such as existing drainage patterns and proposed pathways, infiltration, detention, and storage. Evaluation of required, recommended, and anticipated storm water drainage features shall be included, along with topics such as defining finished floor elevations relative to flood levels and evaluating other storm water drainage sources in the vicinity for potential use within the project site. The final Report shall include a water budget for the proposed landscape, including an analysis of water sources available to meet the budget. Proposed concepts and features shall come from a collaborative process involving all applicable team members. At a minimum this should include the project's Landscape Architect, Civil Engineer, and the project Architect.
- Assessment of anticipated storm water drainage impacts of the project on the surrounding area including the watershed above the site, adjacent storm water drainage relationships and downstream areas potentially affected and likely mitigation needed. Maps should indicate how the site/project interfaces with its own and adjacent watersheds.

5.4.3. Storm Water Drainage Report Submittals

Each draft of the Storm Water Drainage Report will be reviewed by the Owner. Following is a summary of each report draft:

- First Draft: The first draft of the Storm Water Drainage Report shall be included with the projects programming design submittal. The storm water drainage conditions, concepts, features, and mitigation described within the report are to be included in the presentation. All subsequent project presentations and submittal sets shall include

NORTHERN ARIZONA UNIVERSITY DESIGN GUIDELINES

these storm water drainage elements developed to a level of design commensurate with the rest of the project.

- Second Draft: A second draft of the Storm Water Drainage Report shall be due with the schematic and design document phase submittal set. This draft shall include updated/refined graphic and narrative descriptions of storm water drainage concepts, features, and mitigation.
- Final Report: The final version of the Storm Water Drainage Report shall be submitted with the construction document submittal and will include updated modeling and analysis of designed features and mitigation. It shall be sealed by a registered Civil Engineer and shall include calculations, model outputs, assumptions made, and any other relevant information to provide a comprehensive report. An executive summary is to be provided which includes, among other information, a statement from the project Civil Engineer noting in both technical and layman's terms ways in which the project design varies from and/or meets NAU Standards.

REFERENCES:

The City of Flagstaff Low Impact Development: Guidance Manual for Site Design and Implementation (latest revision).

<http://flagstaff.az.gov/index.aspx?NID=1464>

City of Flagstaff Stormwater Management Design Manual (latest revision).

<http://www.flagstaffstormwater.com>

6. CAMPUS SUSTAINABILITY

6.1. OVERVIEW

Northern Arizona University is committed to a leadership role in promoting sustainability on our campus and in our design and construction practices. The University is actively pursuing policies that provide for a sustainable future.

NAU's Sustainability Action Plan (<http://nau.edu/Green-NAU/SAP-Home/>) includes a description of the goals for advancing sustainable building including "providing incentives to use Leadership in Energy and Environmental Design (LEED) standards and other green building practices in the development of facilities".

Much of the reduction in emissions is proposed to come from energy conservation efforts and improved efficiency of new and renovated buildings. These Design Guidelines are part of the effort described in the Sustainability Plan to "phase in a high performance facilities program that makes energy and water conservation objectives and green building design services part of planning all new or renovated facilities."

Where applicable, a Total Cost of Ownership (TCO) analysis may be required, to include environmental, economic and social costs and benefits. Project teams are encouraged to submit a TCO analysis with their initial review package for any proposed design elements with an initial first cost greater than a conventional solution.

Design Professional teams are expected to incorporate sustainable systems within the context of construction and renovation to meet the goals of the Owner.

This is a suggested process for meeting the goals and requirements.

- Establish project-specific benchmarks:
Discuss, record, and document the specific goals for the project during programming and during all phases of design. Most projects will adhere to the benchmarks provided herein but in some cases projects may have more stringent requirements or focus on a certain area. Include the benchmarks selected in the programming documentation.
- Model the building energy and site systems:
During programming and schematic design, the project team will develop a baseline energy model to identify key areas for focus during alternative evaluation. The baseline energy model will be used for alternative evaluation. An update to the model will be provided with each design submittal along with a summary report indicating

NORTHERN ARIZONA UNIVERSITY DESIGN GUIDELINES

assumptions, changes from the previous models, and a monthly consumption estimate for each utility along with peak flow rate.

- Develop and compare alternatives:

During Design Development, the project team will test alternative systems using life cycle cost analysis. Proposed alternatives will be presented, recommended alternatives discussed, and selected alternatives documented in an energy model report included in the design development documents.

- Provide after-construction documentation:

Simple, bulleted list of the sustainable design features (upon completion of construction documents).

One-year post occupancy report (indicating how sustainable goals have or have not been met; what worked and what didn't work; hindsight evaluation - what would you do differently, etc.).

6.2. DESIGN CRITERIA

6.2.1. General:

Sustainable design precepts appropriate for the Northern Arizona mountain environment should be incorporated – water conservation, building orientation, sun exposure, and snow and ice accumulation are issues of special concern in mountain environments.

- Appropriate passive solar design techniques shall be incorporated where the project scope and budget support it, solar water heating and photovoltaic systems should be considered if determined to be economically viable.
- Landscape design shall be in compliance with the 2015 NAU Landscape Master Plan. Water harvesting techniques and use of the Owner's reclaimed water system is required. Protect significant natural and historic landscaping and incorporate those elements into the new landscape design aligned with the 2015 NAU Landscaping Master Plan.
- Appropriate day-lighting design should be considered to minimize the requirements for artificial lighting and to promote the interior/exterior connection of the building.

6.2.2. Building Size & Footprint:

Minimize the overall building size (square footage and footprint) while meeting the building program requirements. The goal is efficient use of space to reduce overall resource consumption; including embodied energy, operational energy, and building materials.

6.2.3. Design for Future Use:

NORTHERN ARIZONA UNIVERSITY DESIGN GUIDELINES

Plan for a “100-year Building” through flexibility of use and future reuse; no “throw-away” buildings. Design interior spaces that are flexible and allow for changes in use. Use standard furniture wherever possible. Minimize use of custom millwork, custom building systems (door frames, doors, interior windows etc.) to maximize reuse in the future. For retrofits, analyze current space requirements for space efficiency, function, and use proximity.

6.2.4. Building Life Expectancy:

Appropriate use of construction materials, mechanical, electrical and plumbing systems should be selected that result in a building with an intended useful life of 100 years, and also respond to the attributes of the Northern Arizona mountain environment.

6.2.5. Programming & Space Planning:

Group spaces or activities with similar energy requirements and times of use to allow for zoning efficiency of passive and mechanical energy systems. The goal is to reduce demand and optimize operational efficiency.

6.2.6. Service Areas:

Service areas shall support efficient operations, program, and building management for NAU sustainability initiatives; such as recycling collection, trash compaction, water capture, service vehicle access, etc.

6.2.7. Transition spaces:

Provide sufficient exterior screening, transition courtyards, exterior atrium spaces, shade trellises, etc., to allow the building occupant the opportunity for eye adjustment from bright to low light and from low to bright light.

6.2.8. Landscape Maintenance:

Reduce maintenance and potential problems caused by landscape debris. Specify plants appropriately for their purpose and location. Avoid overplanting. Consider mature landscape growth potential to insure appropriate integration with lighting, underground utilities and other site systems.

6.2.9. Waste Management:

Owner is working to quantify waste and recycling rates for all ongoing and any future projects on campus. Contractors are asked to identify waste diversion opportunities and track waste and recycling figures for each of their respective projects. Waste and waste diversion totals should be tracked on a monthly basis and entered into the project-specific spreadsheet. Refer to Division 1 of the Technical Standards for Contractor requirements.

6.2.10. User Involvement:

Survey building occupants/users for sustainable design, maintenance and operations suggestions; utilize the recommendations in the design as practicable.

6.2.11. Carbon Neutrality:

A zero carbon emission campus is the NAU goal. Design Professional to evaluate strategies to achieve a carbon neutral project. Energy models are required at certain design subphases in the Design Professional contract. Develop a budget for carbon neutrality based on Schematic Design energy model.

6.2.12. Building Envelope:

Design the building envelope to minimize heat loss and gain. Exceed the current ASHRAE (American Society of Heating, Refrigerating and Air-Conditioning Engineers) building envelope performance baseline standard by 30% or more. Avoid thermal bridging by providing thermal breaks in the exterior building envelope.

6.2.13. Climate-Responsive and Passive Systems Design:

Design buildings in a climate-responsive manner to reduce energy demand, maximize passive heating and cooling, and minimize mechanical HVAC requirements (through building form, orientation, articulated shading, natural ventilation, glazing, interior thermal mass, blinds, controls, geothermal energy, earth tempering, etc.)

6.2.14. Window Glazing:

Select glazing size and materials appropriate for the orientation of the windows. Use double or triple glazing wherever possible. Thermal breaks shall be included in window frames at all exterior glazing.

6.2.15. Window Shading:

Every exterior window shall be shaded appropriately for the window orientation. Consider cleaning and maintenance of windows and shading devices in the design. Provide a shading analysis for review. Ensure that operable interior shading is accessible to the building occupants.

6.2.16. Mechanical Systems:

Specify HVAC and electrical systems that find a balance between energy efficiency and maintainability. Coordinate systems and controls with other building systems to optimize building operation and reduce energy consumption on a Total Cost of Ownership basis. Motion sensors and daylight-responsive dimming will be evaluated on a project needs basis. Provide electronic ventilation controls. Connection to the Central Plant heating and cooling systems is to be evaluated on every project. Consider extended life cycle maintenance and material costs in MEP systems design. Use heat recovery systems wherever possible to minimize energy usage.

The DP shall include a written description of how the mechanical systems are to operate and interface with other systems within the BOD. A detailed written sequence of operations is to be included within the plans at the Design Deliverable submittal.

6.2.17. Energy Commissioning & Monitoring:

In regards to projects that effect NAU's energy system, provide clear building energy commissioning requirements beginning in schematic design to establish energy goals, and ending with a post-occupancy energy analysis. Provide permanent energy metering on all buildings utilizing the Owner's metering standards for every utility connected to the building. Metering of building sub systems may be needed based on project or LEED requirements. Provide the capability to monitor and analyze post-occupancy performance in comparison to energy analysis predictions. Provide a 1-year and 2-year post occupancy energy use analysis for Tier 1 and Tier 2 projects (see below for more information on Tiers).

6.2.18. Preliminary Water Budget Analysis:

In regards to projects that effect NAU's water systems, perform a preliminary water budget analysis before the completion of schematic design that explores how to reduce potable water loads in the building and accomplish related sustainability goals. Assess and estimate the project's potential non-potable water supply sources and water demand volumes, including indoor water demand, outdoor water demand, process water demand, and supply sources. Non-potable water source evaluations can include on-site rainwater and/or graywater, and HVAC equipment condensate.

Document how the above analysis informed building and site design decisions in the project's BOD. Demonstrate how at least one on-site non-potable water supply source other than reclaimed water was analyzed to reduce the burden on municipal supply or wastewater treatment systems by contributing to at least two of the water demand components listed above.

6.2.19. Climate-Responsive Materials:

Specify materials that are durable under high-altitude desert climate conditions (UV radiation exposure and freeze/thaw).

6.2.20. Embodied Energy:

Minimize the use of high embodied-energy materials.

6.2.21. Reused & Repurposed Materials:

Present opportunities for installation of reused and repurposed materials, including the building shell, structural materials, finishes, fixtures, etc.

6.2.22. Maintenance:

NORTHERN ARIZONA UNIVERSITY DESIGN GUIDELINES

Specify low maintenance materials and assemblies. Material and building maintenance, and special cleaning procedures, shall be reviewed with Owner in the design development phase for integration into the NAU sustainable cleaning program standards.

6.2.23. Building Construction Supervision

Schedule on-site quality control inspections to check for/assure freedom from heat bridges. Assure that insulation layers are continuous, and without air pockets. Check joint details for air tightness while they are accessible. Have a building shell pressure test performed as part of the building commissioning.

6.3. ASHRAE 189.1

New construction must adhere to the most recent version of American Society of Heating, Refrigeration, and Air-conditioning Engineers (ASHRAE) ASHRAE 189.1.

6.4. USGBC LEED CERTIFICATION

The State of Arizona mandates for all state facilities achieve LEED Silver certification as established by the United States Green Building Council on all new buildings and renovations.

All projects will adhere to the most recent version of USGBC LEED standards as of date of DP contract. Projects will use the most recent LEED project management software to register, document and certify projects. The DP must register the project with USGBC within five (5) days of the execution of the DP contract.

The requirements and recommendations for LEED [sustainability] elements to be incorporated into major renovations projects are organized into four categories that align with NAU project tiers as described below.

Tier 1	Tier 2	Tier 3
New Building or Major Renovation	Partial Renovation	MEP System Upgrades
New Buildings and Building-Wide Full-Gut Renovations	Partial Building Interior Fit-Outs HVAC, Lighting, and Materials Within the Scope	Limited Scope Projects with Energy and GHG Impact

Design Professional shall clarify with Owner on what Tier is to be used on a project.

6.4.1. Tier 1 – New Building or Major Renovations

6.4.1.1. Mandatory LEED Points

Owner has identified explicit LEED points (LEED Silver certified) for mandatory consideration and inclusion in Tier 1 projects. Those points are listed below.

NORTHERN ARIZONA UNIVERSITY DESIGN GUIDELINES

The below credits should be pursued for all LEED certification projects. If unable to achieve those credits, a thorough written explanation of the reasons why, shall be provided to Owner.

6.4.1.1.1. INTEGRATIVE PROCESS

- a. **Credit – Integrative Process** - Adhere to the requirements of the LEED Credit: Integrative Process (based on ANSI Consensus National Guide 2.0 for Design and Construction of Sustainable Buildings and Communities – 2012).

6.4.1.1.2. LOCATION AND TRANSPORTATION

- a. **Credit – Surrounding Density and Diverse Uses**
- b. **Credit– Access to Quality Transit**
- c. **Credit – Bicycle Facilities** - Public transportation access should be consistent with Owner’s Campus Master Plan. Provide ample bike rack space to accommodate both staff and student use of the building. Consider need for roof, area drains and lighting for bicycle storage areas/racks. Consider snow removal and bike storage.

6.4.1.1.3. SITE DEVELOPMENT

- a. **Credit - Open Space** - Ensure that the percentage of outdoor space on campus is not decreased below 30%. Consider building heights greater than 3 stories.
- b. **Credit - Heat Island Effect: Roof and/or Non-Roof**
- c. **Credit - Light Pollution Reduction**

6.4.1.1.4. WATER EFFICIENCY

- a. **Credit– Outdoor Water Use Reduction**
- b. **Credit– Indoor Water Use Reduction** - Provide opportunities for rainwater harvesting and condensate collection. Refer to Division 22 of the Technical Standards for low-water usage plumbing fixtures
- c. **Credit– Cooling Tower Water Use** - Any buildings requiring air-conditioning should be connected to the chilled-water distribution systems. Owner exceeds the minimum 10-cycles.

6.4.1.1.5. ENERGY & ATMOSPHERE

- a. **Prerequisite - Building-Level Energy Metering** - The Owner will commit to sharing with USGBC the resulting whole-project water usage data for a five-year period beginning on the date the project accepts LEED certification or typical occupancy, whichever comes first.

NORTHERN ARIZONA UNIVERSITY DESIGN GUIDELINES

- b. **Credit - Enhanced commissioning**
- c. **Credit - Optimize Energy Performance** - Thirty-four percent (34%) improvement in building performance beyond current LEED requirement is the preferred minimum level for new facilities. Additional improvements may be required based on LEED objectives.
- d. **Credit - Renewable Energy Production** - If renewable energy installation is cost prohibitive, assess the potential for buildings and roofs to be “solar ready.”

6.4.1.1.6. MATERIALS & RESOURCES

- a. **Prerequisite - Storage & Collection of Recyclables** Recyclable materials must include mixed paper, corrugated cardboard, glass, plastics, and metals. NAU’s current commingled recycling pickups does not allow for inclusion of glass. A separate area and receptacle is recycled for glass storage and pickup. Provide locations for recyclable materials collection bins on floor plans. Such collection bins shall match tech’ standards section Division 12.90.0 – Furnishings. Take appropriate measures for safe collection, storage, and disposal of at least two of the following: batteries, mercury-containing lamps, and electronic waste.
- b. **Credit– Building Life-Cycle Impact Reduction**
- c. **Credit– Building Product Disclosure: Environmental Product Declarations** - Select materials that are manufactured as close as possible and avoid materials coming from oversea with long procurement lead-time. Think globally about the total carbon footprint of the selected materials.

For permanently installed products (including mechanical fixtures and fittings and rough-in materials), consider products with Environmental Product Declarations which conforms to ISO 14025, 14040, 14044, and EN 15804 or ISO 21930 and have at least a cradle to grave scope.

- d. **Credit– Building Product Disclosure: Sourcing of Raw Materials**
- e. **Credit– Building Product Disclosure: Sourcing of Raw Material Ingredients** - Consider the use of products with ingredient reporting programs such as “Cradle 2 Cradle”.
- f. **Credit– Construction Waste Management** - Divert at least 80% of new construction from disposal, consisting of three of the five previously defined waste streams, as designated in project planning. Collect weekly waste reports for the waste stream of the three specified materials, as well as the total weight of all materials

NORTHERN ARIZONA UNIVERSITY DESIGN GUIDELINES

recycled or sent to disposal for a particular project. Waste and diversion data should be regularly shared with the University.

6.4.1.1.7. INDOOR ENVIRONMENTAL QUALITY

- a. **Credit– Enhanced Indoor Air Quality** - Will required printers to be in dedicated rooms. MERV 13 filters will be required for these spaces.
- b. **Credit– Low-Emitting Materials** - Low emitting materials should meet the requirements of CDPH Standard Method V1.12010 and applicable chemical content requirements of the SCAQMD Rule 1168.
- c. **Credit– Construction IAQ Management Plan** - These filters shall be replaced prior to occupancy and shall be MERV 13.
- d. **Credit–IAQ Assessment**
- e. **Credit– Daylight**

6.4.1.2. Recommended LEED Points

It is required that the credits below be assessed for potential achievement. If unable to achieve these credits, a thorough written explanation of the reasons why, will be provided.

Assessment is Required for the Following LEED Credits to Determine appropriateness for

- SS: Rainwater Management
- SS: Site Assessment
- EA: Enhanced Energy Metering
- EA: Enhanced Refrigerant Management
- IEQ: Interior Lighting Controls
- IEQ: Thermal Comfort Controls
- IEQ: Acoustic Performance
- **Credit– Advanced Metering** - Coordinate with Owner to identify the benefit of installing permanent water meters for two or more of the following water subsystems, as applicable to the project: irrigation; indoor plumbing fixtures and fittings; domestic hot water; reclaimed water; boiler; and/or other process water.

6.4.2. TIER 2 – Partial Renovation

6.4.2.1. Identify sustainability goals and tracking mechanisms

Specifically address sustainable goals and tracking that sets expectations and evaluates project success in meeting pre-defined goals.

6.4.2.2. Integrated Design

NORTHERN ARIZONA UNIVERSITY DESIGN GUIDELINES

Projects are encouraged, but not required, to adhere to the requirements of LEED IP credit 1: Integrative Process.

6.4.2.3. Energy Modeling and GHG Emissions Calculations

6.4.2.4. LEED / Sustainability Requirements

Owner has identified sustainability requirements outlined within the LEED v4 Rating System that Tier 2 projects

6.4.2.4.1. Water Efficiency

- a. Indoor Water Use Reduction – Reduce potable water use by 35% (minimum, from a calculated baseline)
- b. Outdoor Water Use Reduction – Sub-meter irrigation separately from all other potable water use. Strive for a 100% reduction in outdoor potable water Use.

6.4.2.4.2. Optimize energy performance by 35%

- a. Lighting retrofit and motion detection switching
- b. Evaluation of existing building insulation and addition of insulation
- c. Replace windows
- d. Replace roofing
- e. HVAC upgrades with better air handling units (AHU)
- f. Equipment and appliances are ENERGY STAR compliant

6.4.2.4.3. Energy and Atmosphere

- a. Enhanced commissioning
- b. Enhanced refrigerant management
- c. Building management systems
- d. Measurement and Verification – Sub-metering of major systems

6.4.2.4.4. Materials and Resources

- a. Construction Waste Management – Reduce waste by 50%
- b. Building Product Disclosure/Optimization – Environmental Product Declarations
- c. Building Product Disclosure and Optimization – Sourcing of Raw Materials
- d. Building Product Disclosure and Optimization – Materials Ingredients and Product Manufacturer Supply Chain Optimization

6.4.2.5. Recommendations

The following sustainable elements are not required for consideration within Tier 2 projects, but are strongly recommended as project scope, budget, and other considerations allow; especially for projects in the Tier 2A category.

- a. SS: Rainwater Management
- b. SS: Heat Island Reduction
- c. SS: Light Pollution Reduction
- d. SS: Sustainable Sites Initiative (if project is primarily a landscape project)
- e. MR: Storage and Collection of Recyclables

6.4.3. Tier 3 – MEP System Upgrades

6.4.3.1. Energy Modeling and GHG Emissions Calculations

Projects are encouraged, as appropriate to the project type, to estimate the energy demand and consumption impacts, as well as GHG emissions, from the proposed design options and propose a strategy to verify energy performance.

6.4.3.2. LEED / Sustainability Requirements

Owner has identified sustainability requirements outlined within the LEED v4 Rating System that Tier 3 projects should always strive to incorporate, when appropriate.

6.4.3.2.1. Energy Efficiency

- a. Building Envelope - Opaque and/or Glazing
- b. HVAC Equipment Efficiency – Zoning and Controls
- c. Interior Lighting Power – 10-25% Reduction in Lighting Power Density
- d. Interior Lighting Controls – Daylighting and Occupancy Sensor Lighting Controls
- e. Equipment and Appliances – ENERGY STAR Equipment and Appliances: 70-90% Compliance

6.4.3.2.2. Water Efficiency

- a. Indoor Water Use Reduction – Reduce potable water use by 35% (minimum, from a calculated baseline)
- b. Outdoor Water Use Reduction – Sub-meter irrigation separately from all other potable water use. Strive for a 100% reduction in outdoor potable water Use.

6.5. ENERGY MODELING

Energy modeling is essential to understanding the contribution of an element to the system function efficiency. Energy modeling captures the advantages of certain materials in reduction of energy during facility operation. The systems included are primarily mechanical, electrical and plumbing as well as heating, ventilation and cooling (HVAC). For the elements included in the building envelope: subflooring, walls, roof, insulation, and glazing the cost/benefit is realized in energy savings due to better performance of the material for insulating, moisture management, and heat transfer. The energy model provides information that the building owner needs to properly evaluate different design alternatives.

The energy model will be based on LEED requirements for the baseline building. Utilize eQuest or Energy Plus platforms to model proposed building design, assist with life cycle costing, estimate greenhouse gas (GHG) emissions, and facilitate measurement and verification.

At a minimum, the following deliverables or reports summarizing these deliverables are required:

**NORTHERN ARIZONA UNIVERSITY
DESIGN GUIDELINES**

Schematic Design	Initial model results of massing, orientation, and/or major HVAC systems with sensitivity analysis
Design Development	Multiple parametric runs comparing options of systems and strategies as determined in the initial and/or subsequent integrated design charrettes
Construction Documents	Complete design and base case models used for LEED and/or code compliance verification
Building Turnover	As-built energy model & electronic files

The HVAC system described in Technical Standards Section 23 00 00 (variable air volume, single duct, with terminal reheat) must be modeled. Any additional alternative to the LEED baseline HVAC system will be modeled and evaluated based on efficiency and maintainability. Owner requires the energy savings data to be compared between the LEED baseline HVAC system, Owner preferred HVAC system, and any proposed alternative HVAC system. The model inputs and reports will be submitted at each stage of design and with every design submission. Modeling based on ASHRAE 189.1 is required.

The energy model should capture the role of components in the system performance. A Total Cost of Ownership analysis of components that are part of an energy system without an appropriate model included will be deemed incomplete and inconclusive. Providing a complete energy model and Total Cost of Ownership report is a requirement for progress payment to the DP.

6.6. BUILDING LIFE CYCLE COST (BLCC) ANALYSIS AND BUILDING COMPONENT SELECTION

6.6.1. “Total Cost of Ownership”

Throughout the process of scoping, design, and sometimes during construction, building components are selected and included in the building design. Rather than base decisions for inclusion of components in the project solely on the construction budget and initial installed cost, elements included in the project must be evaluated for building life cycle cost (BLCC). The BLCC analysis includes the costs and benefits for the lifetime of a building for a product or a system including but not limited to: the initial cost of material and installation, energy savings, maintenance costs, and product life. BLCC analyses provide the Owner with a true cost of alternatives under consideration. These analyses can then be used to compare acceptable construction materials and to differentiate the actual cost of materials to the Owner.

6.6.2. Building Life Cycle Evaluation Process and Procedure Guidelines

The Design Professional shall identify the elements to be evaluated for BLCC Analysis based on the performance goals established for the building and the available options. Any alternatives considered shall be viable options acceptable to Owner. BLCC Analysis

NORTHERN ARIZONA UNIVERSITY DESIGN GUIDELINES

shall be formally documented in the reports as required in the project development, schematic design and design development. Final selections will be made by the project team, with final approval by Owner, as part of construction plan completion and BLCC may not be the sole criteria used to perform selection of building systems and building materials.

Energy escalation rates and the discount factor will be derived from the latest *Energy Price Indices and Discount Factors for Life-Cycle Cost Analysis, Annual Supplement to NIST Handbook 135*, published by the National Institute of Standards and Technology (NIST), or as directed by the Owner. Owner recognizes that proposed alternatives may not prove cost effective based on BLCC analysis but the alternative may be deemed necessary to meet the energy reduction goal and minimize the carbon footprint of the building. This situation occurs predominately in the “Optimize Energy Performance” credit of the LEED certification process. The BLCC analysis and LEED energy savings impact will be evaluated on a case by case basis. Utilize the building energy model report in the creation of the BLCC.

The following building systems shall be considered for BLCC analysis at conceptual and schematic design and again if major changes occur in later design subphases:

1. Energy systems
2. Electrical Systems
3. Building Envelope
4. Sitting/Massing Strategies
5. Structural Systems
6. Mechanical Systems
7. Water Systems
8. Interior Materials

Goals shall be established for each of the systems as listed above. Specific required studies include: roofing alternatives within the building envelope category, HVAC system alternatives within energy systems, and flooring as part of interior materials. No more than three studies shall be completed within the same category.

6.6.3. Resources

The following resources were identified as potential methods for BLCC Analysis:

- The US Department of Energy provides a life cycle cost analysis program through The National Institute of Standards and Technology and provides a program to assist in BLCC Analyses.
- BLCC conducts economic analyses by evaluating the relative cost effectiveness of alternative buildings and building-related systems or components. Typically, BLCC is used to evaluate alternative designs that have higher initial costs but lower operating costs over the project life than the lowest-initial-cost design. It is

NORTHERN ARIZONA UNIVERSITY DESIGN GUIDELINES

especially useful for evaluating the costs and benefits of energy and water conservation and renewable energy projects. The life-cycle cost (LCC) of two or more alternative designs are computed and compared to determine which has the lowest LCC and is therefore more economical in the long run. BLCC also calculates comparative economic measures for alternative designs, including net savings, savings-to-investment ratio, adjusted internal rate of return, and years to payback.

The software can be used to evaluate projects for both new and existing buildings. While BLCC is oriented toward construction-related decisions, it can be used to evaluate alternative designs for almost any project type in which higher capital investment costs lead to lower future operating-related costs (NIST website, 2009).

Designers are expected to be well versed in modeling and to have the ability to demonstrate the accuracy of the proposed model using existing facilities and locally and regionally appropriate data.

6.7. OPERATION & MAINTENANCE

6.7.1 Building “Owner’s Manual”: Provide a Building Owner’s Manual (in digital format) on how to operate and maintain the building and site to optimize the building systems and design.

6.7.2 Operation & Maintenance Education: Conduct a workshop for Owner, including building occupants and maintenance staff, prior to occupancy to review the “Building Owner’s Manual” and direct building users on how to optimize the building systems and design.

6.7.3 Post-Occupancy Evaluation: Post-occupancy evaluations will be performed by the DP or a consultant retained by the DP at the end of the first year of occupancy. The evaluation shall include performance and satisfaction assessments of building comfort, HVAC systems operations & controls, water and energy use, lighting, etc.

6.8. BUILDING EDUCATION

6.8.1 Resource Usage Information Display: Buildings are not static in nature and therefore it is important to provide feedback to the users on their effect on energy, water and other resource consumption as they use the buildings. Provide smart meters to educate and influence user behavior with the goal of reducing energy consumption.

6.8.2 Interpretation: Buildings should be an educational opportunity for the users, to educate the users on energy savings and resource saving features of buildings. Provide

NORTHERN ARIZONA UNIVERSITY DESIGN GUIDELINES

innovative ways to educate users about the sustainable building design, through the use of signage, displays (green screen or other form) and any other appropriate communication device to explain design strategies, techniques, technologies, etc.

7. CAMPUS METERING

Utility metering is required for all new construction and renovation projects that include energy or water consuming components. Utility meters shall be designed and specified by the Design Professional. Contractor shall furnish and install all utility meters. Utility meter commissioning shall be a joint effort between the Contractor, Design Professional, Commissioning Agent (where applicable), and the Owner. Owner will not accept any utility meter until it has been shown to be fully functioning and operational. Refer to section 23 05 19 for Mechanical Meter Standard and 26 09 13 for Electrical Power meters.

Utility meters shall communicate with the Owner's Energy Management System (EMS), which is Alerton. Specify all necessary components and communication protocols to assure meter information can be mapped to campus Building EMS Web Page.

8. CAMPUS ACCESSIBILITY AND UNIVERSAL DESIGN

8.1. Universal Design

Owner is committed to universal design (UD) in all construction projects whether they are new facilities or facility renovations. Owner is committed to providing equitable access to its working, learning and cultural activities for all individuals. Universal design serves to create usable and sustainable spaces which are usable by all members and guests of the Owner's community.

Universal design "is not a design style, but an orientation to any design process that begins with a responsibility to the experience of the user" (Institute for Human Centered Design, 2010). It is a proactive approach to design considerations in the physical environment, as well as the information, policy, and learning environments. Considering the experience of the user prior to making design decisions can create long-term efficiencies for the institution by minimizing the need for future adaptations and retrofitting.

The Center for Universal Design at North Carolina State University has defined universal design as "the design of products and environments to be usable by all people, to the greatest extent possible, without the need for adaptation or specialized design" (Center for Universal Design, 1997). In supporting this definition, it has identified seven primary principles of universal design for products and environments.

(see http://www.ncsu.edu/www/ncsu/design/sod5/cud/about_ud/udprinciples.htm)

These principles are:

- Principle 1: Equitable use
- Principle 2: Flexible use
- Principle 3: Simple and Intuitive Use
- Principle 4: Perceptible Information
- Principle 5: Tolerance for Error
- Principle 6: Low Physical Effort
- Principle 7: Size and Space for Approach and Use

These principles are described in detail at the website listed above. This information, and other reference material, can also be found on Northern Arizona University's Commission on Disability Access and Design website at <http://nau.edu/cdad/>.

Projects involving building/sites on the National Register of Historic Places must comply with the Universal Design principles and accessibility standards in such a way that impact is minimized and a building/site's historic integrity and character defining features are maintained. The determination of building/site's historical integrity and character defining features shall be discussed with the Owner and the State Historic Preservation Office.

NORTHERN ARIZONA UNIVERSITY DESIGN GUIDELINES

Due to potential range of existing conditions – and the ability of renovation (or historic renovation) project to address such conditions – it is imperative that each project involving an existing building undergo evaluation early in the design process to outline the scope of accessibility compliance which can be achieved.

All construction projects – new, renovation and historic renovation – must comply with the ANSI 117.1 accessibility requirements (as a referenced standard in the IBC). In addition, must comply with the 2010 ADA Standards, as adopted by the Department of Justice (DOJ) in September 2010 and their related standards as they apply. Compliance shall also conform to the requirements of the latest editions of all state regulations and the various codes which have been adopted by the Owner at the time of bid or qualifications-based selection.

New construction projects must comply with mandatory standards throughout both the building and site. Additions to existing buildings must comply with mandatory standards throughout the building and – if provided with new building entrances from the exterior – the site. Renovation projects must comply with mandatory standards within the physical boundaries of the renovation.

In regards to achieving accessibility as part of renovations, Owner recognizes that there are some challenges renovation projects cannot overcome, such as:

- Conditions physically beyond the limits of the renovation
- Spatial/structural/technical conditions which make accessibility infeasible to achieve, and/or
- Conditions which cannot be addressed within a defined project scope or budget.

Many of the UD accessibility standards become preferences – rather than mandatory – when there are significant constraints to achieving accessibility. However, Owner expects Design Professional to bring an innovative and resourceful approach to renovation projects on campus, and strive to achieve compliance with the UD accessibility standards.

8.2. International Symbol of Accessibility

In lieu of utilizing 2010 ADA Figure 703.7.2.1 “International Symbol of Accessibility” for all accessibility signage; the following likeness and description of the “International Symbol of Accessibility” will be utilized, as found at the following website:

<http://www.accessibleicon.org/icon.html>.

The use of this International Symbol of Accessibility is mandatory on all new construction and major renovation projects, as well as for all parking facilities. Small renovations would continue to use the current 2010 ADA Figure 703.7.2.1 symbol as to maintain signage consistency within a building.



Sample Icon

NAU'S Equivalent Facilitation Notes: NAU has agreed that slight variations on the historical "International Symbol of Accessibility" could be generally permissible as long as the symbol clearly displays a wheelchair and signifies accessibility. Please reference 2010 ADA section "**103 Equivalent Facilitation**. Nothing in these requirements prevents the use of designs, products, or technologies as alternatives to those prescribed, provided they result in substantially equivalent or greater accessibility and usability."; and 2010 ADA "**Advisory 103 Equivalent Facilitation**. The responsibility for demonstrating equivalent facilitation in the event of a challenge rests with the covered entity. With the exception of transit facilities, which are covered by regulations issued by the Department of Transportation, there is no process for certifying that an alternative design provides equivalent facilitation."

8.3. Accessibility

8.3.1. Building Basics

8.3.1.1. ADA Guidelines

- All work must conform to the 2010 ADA Standards for Accessible Design: https://www.ada.gov/regs2010/2010ADAStandards/2010ADAStandards_pr_t.pdf.
- Design Professionals must consider the effects of renovations on the existing space with regard to accessibility, and in particular the path of travel in "an alteration that affects or could affect the usability of or access to an area of a facility that contains a primary function" (ADA Standards 2010). The 2010 ADA Standards for Accessible Design have a disproportionality measure if the alteration to an area exceeds 20% of the cost of the alteration to the primary function area. A worksheet and calculation example developed by NAU is available for assistance on this matter at: http://nau.edu/Facility-Services/DP_Contract/.

8.3.1.2. Reach Ranges

- The operable portion of building equipment and controls (such as electrical switches, fire alarm pull stations, above-work-surface telephone and data outlets, thermostats, elevator call buttons, etc.) shall be located no higher than 44 inches above the finished floor.

NORTHERN ARIZONA UNIVERSITY DESIGN GUIDELINES

- Proximity door access card devices shall be used in areas where required for security. They will be centered no higher than 38 inches above the finished floor.
- Control plates for automatic door openers shall be centered 36 inches above the finished floor.

8.3.2. Accessible Routes

8.3.2.1. During Construction

- Renovations that temporarily eliminate building-wide accessibility accommodations (i.e. change of building entrance, access through building, accessible restrooms, elevators, etc.) shall provide comparable, temporary replacements-including temporary directional signage-for said accommodations.
- Construction fencing/staging, earthwork, temporary drainage conditions shall be designed to maintain existing accessible routes or alternative, temporary accessible routes-including temporary directional signage-shall be provided.
- Temporary ramps used during construction must comply with ADA Accessibility Guidelines (ADAAG) regulations.
- Refer to Division 1 for additional Contractor requirements.

8.3.2.2. Surface Materials

- Decorative ground surface treatments (i.e. exposed aggregate concrete, unit pavers, stone paving, etc.) shall not be on an accessible route.
- Granular surface materials used to create exterior paths of travel shall provide a stable surface that is usable during all weather conditions.
- Changes in surface material-both inside and outside-shall be provided with a durable transition/threshold that will meet the change in elevation height requirement throughout the life of the building/space.
- Granular surface materials may not be used on path of travel surfaces with a slope greater than 1:20.
- Owner's standard for detectable warning surface is truncated domes pavers.

8.3.2.3. Building Entrances

- The main entrance of a building shall be universally accessible via a single route.
- All building entrances shall be accessible-including employee entrances or entrances other than the main entrance.

8.3.2.4. Doors and Doorways

- Kick-plates shall be provided on non-latching/push-pull hardware-type doors.
- All latching door hardware shall be lever handle type.
- In the case of revolving doors being used, an adjacent single door, minimum 36 inches wide, mechanically operated, shall be provided.

8.3.2.5. Ramps

- Where changes in elevation are encountered (including courtyards and open spaces) full consideration shall be given to universally accessible design that addresses elevation change.
- Where grades/space allow, sloped sidewalks (slope 1:20 or flatter) shall be used to overcome changes in elevation.
- Ramps (defined as anything steeper than 1:20 slope) shall have a maximum of 1:16 slope.

8.3.2.6. Curb Ramps (curb cuts)

- Curb ramp slopes shall be 1:12.
- Concrete aprons shall be provided at the bottom of the curb ramps.
- Curb ramps within sidewalks (parallel to the path of travel) shall be provided with a 1:16 slope.
- Owner's standard for detectable warning surfaces is truncated domes in a contrasting color.
- The depth of detectable warning surface in the direction of travel shall not exceed 24 inches.

8.3.2.7. Automatic Door Operators

- Automatic door operators shall be installed at each entrance to a building.
- For guidance on horizontal placement of control plates for Automatic Door Operators, refer to diagrams C-12-D-1 through C-12-D-6 on next page. For vertical placement of control plate for Automatic Door Operators, refer to Section 1-Building Basics-Reach Ranges of the ADA Accessibility Guidelines (ADAAG 404.3).

8.3.2.8. Elevators and Lifts

- Elevator cabins shall be accessible.
- Platform lifts shall not be used.

NORTHERN ARIZONA UNIVERSITY DESIGN GUIDELINES

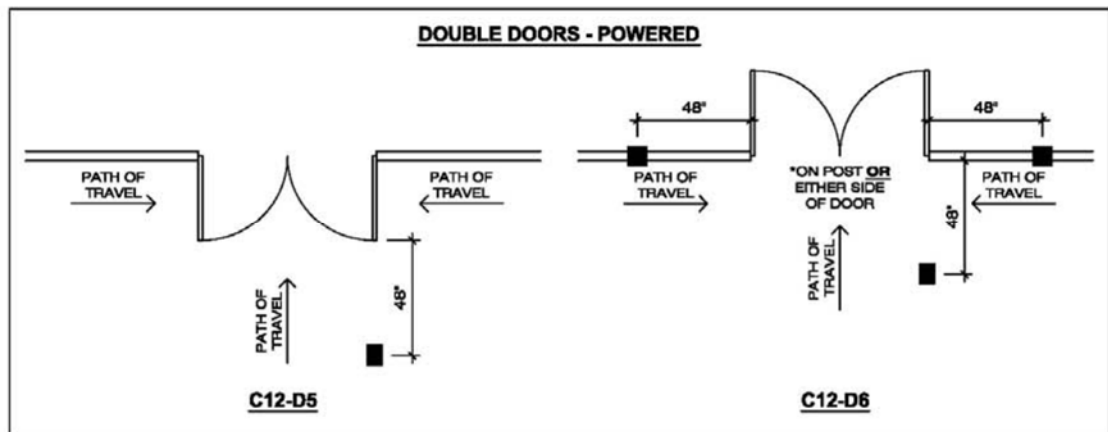
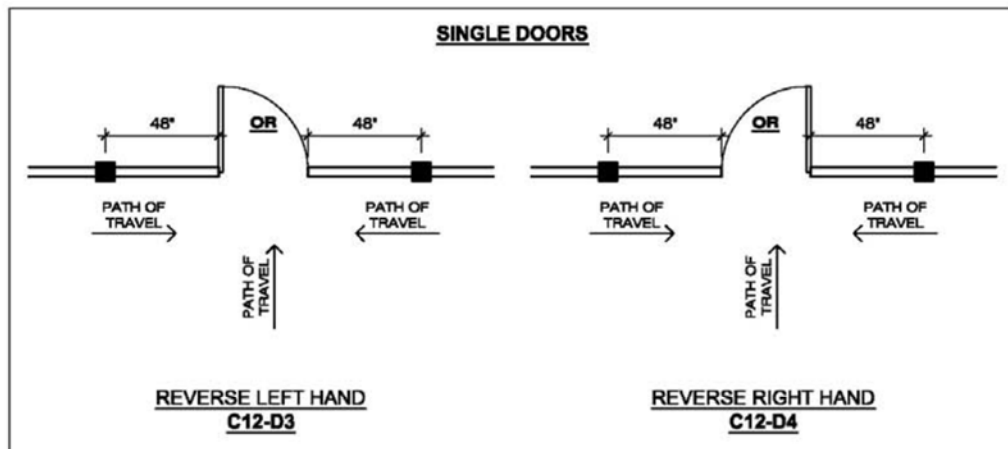
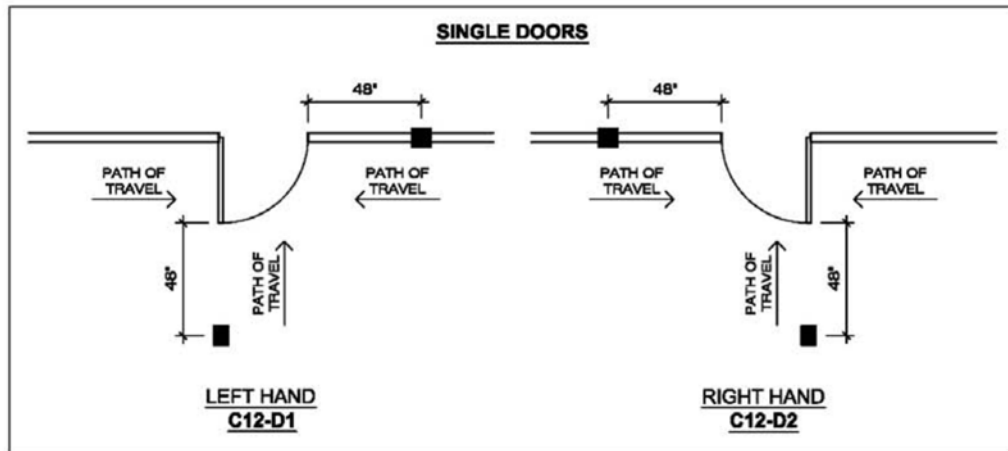

8.3.3. General Site and building Elements

8.3.3.1. Parking Spaces

Intent, Purpose and Goals: The intent and purpose of these requirements are to establish minimum requirements to safeguard the public health, safety and general welfare of those individuals making use of “Accessible Vehicle Space(s)” and “Accessible route(s)” at vehicular traffic areas. They are not intended as a complete set of specifications for their construction.

It should be noted that the following items are in addition to Owner’s adopted Codes and mandatory ADA requirements (see NAU Technical Standards Division 1, section number 01 41 13, “Codes”). For the purpose of clarity, additional items such as code & ADA requirements may have partially been replicated within these technical requirements.

General and Owner Technical Requirements: Accessible parking spaces and required accessible routes shall at least comply with Owner’s adopted codes and mandatory ADA requirements. Additionally, it shall comply with the following additional Owner requirements, listed in subsequent sections.

Exception - Owner Technical Requirements: Where Owner determines that compliance with any section/item of the following Owner technical requirement(s) would create an unreasonable hardship, a variance or waiver may be requested in writing and granted when equivalent facilitation is provided. Approval must be granted by the enforcing organization. The enforcing organization shall at least include the NAU Project Manager, NAU Parking Services, NAU Equity and Access Office, and NAU Building Official (Additional approvals may be required, as determined by NAU Project Manager.)

8.3.3.2. Location of “Accessible Vehicle Spaces” and “Accessible route(s)” at vehicular traffic areas:

Accessible parking spaces shall be located so that persons with disabilities are not compelled to wheel or walk behind parked cars other than their own.

Exception: Parking spaces may be provided which would require a person with a disability to wheel or walk behind a parking space other than that person's own accessible parking space when the NAU enforcing organization determines that compliance with these regulations or providing equivalent facilitation would create an unreasonable hardship. The enforcing organization shall at least include the NAU Project Manager, and NAU Parking Services, and NAU Affirmative Action, and NAU Disability Resources, and NAU Building Official (Additional approvals may be required, as determined by NAU Project Manager.)

NORTHERN ARIZONA UNIVERSITY DESIGN GUIDELINES

Crosswalk At Hazardous Vehicular Areas. When practical, the accessible route shall not cross lanes for vehicular traffic. When crossing vehicle traffic lanes is necessary (for example, such as but not limited to the following situations: Local fire engine access requirements prohibit parking immediately adjacent to a building. etc.) then the accessible route shall be designated and marked as a crosswalk. The crosswalk shall run perpendicular to the vehicular route.

Accessible Routes Located Alongside Hazardous Vehicular Areas. If an accessible route adjoins a vehicular way, and the walking surfaces are not separated by curbs or other elements (e.g. planters or other streetscape designs, parking spaces, etc.) between the pedestrian areas and hazardous vehicular areas, the boundary between the areas shall be defined by an approved continuous railing or other approved type of vehicle barrier.

Advisory note: Please be advised that as per the, “Proposed Accessibility Guidelines for Pedestrian Facilities in the Public Right-of-Way” R208: “Detectable warning surfaces are not intended to provide way-finding for pedestrians who are blind or have low vision.” <https://www.access-board.gov/guidelines-and-standards/streets-sidewalks/public-rights-of-way/guidance-and-research/detectable-warnings-update>

8.3.3.3. Dimensions, Marking and Identification of Surfaces, located at Accessible Parking Space(s) and Access Aisle(s):

Width: Accessible car parking space(s) shall be 108 inches (9 ft) wide minimum and van parking spaces shall be 132 inches (11 ft) wide minimum. Access aisles serving car and accessible van parking spaces shall be 60 inches (5 ft) wide maximum.

Non-Accessible parking spaces shall be 102 inches (8 ft 6 inches) wide minimum and 108 inches (9ft) maximum. The objective is to minimize the width of parking spaces, and maximize the total number of parking spaces in the space available.

Length: The minimum length of each accessible parking space shall be 18 feet (216 inches).

Marking of Ground or Surface at Accessible Parking Space: The accessible parking space shall be marked by a border painted with lines in yellow. The yellow painted lines shall be at least 4 inches wide, and shall be one consistent color.

Each accessible parking space shall have a surface identification duplicating the following scheme: By outlining an International Symbol of Accessibility on

NORTHERN ARIZONA UNIVERSITY DESIGN GUIDELINES

the ground in the space in yellow on blue background. The International Symbol of Accessibility shall be a minimum 36 inches high by 36 inches wide (3 ft x 3ft) and shall be aligned with the end of the stall or space adjacent to the traffic aisle so that it is visible to a traffic enforcement officer when a vehicle is properly parked in the space.

Marking of Ground or Surface at Access Aisle: The accessible loading and unloading access aisle shall be marked by a border, whereas the painted lines are yellow and at least 4 inches wide. Within the border, hatched lines a maximum of 36 inches on center shall be at least 4 inches wide and painted Yellow. The words "NO PARKING" shall be painted on the ground within each 5-foot wide loading and unloading access aisle. This notice shall be painted yellow in uppercase letters, no less than 10 inches high, and clearly identifiable as written, and located so that it is visible to traffic enforcement officials.

Identification Signs: Marking symbols & wording (as noted above) painted over parking surfaces / access aisles must also be used to supplement the following identification sign requirements. Parking space identification signs shall include the International Symbol of Accessibility (please reference adopted codes and ADA for further requirements), and shall be installed in front of each accessible parking space. The signs shall be displayed on fixed mountings in an area where they are not hidden from view, and so they cannot be obscured by a vehicle parked in the space. An additional sign or additional language below the International Symbol of Accessibility shall state "NAU PERMIT REQUIRED".

Directional Signage, Located between Accessible Parking and Building Entrances: Where there are inaccessible building entrances and inaccessible exterior routes, directional signage should be provided, indicating the nearest available accessible route to the nearest accessible building entrance or like accessible element. These directional signs shall include the International Symbol of Accessibility and directional arrow.

8.3.3.4. 8.3.3.4 Approvals & Permit Requirements:

Construction permits and plan review approvals are required for all new and existing "parking facilities" on campus, and under any one or more of the following circumstances:

- Re-striping, new striping.
- Resurfaced, resealed, newly surfaced, newly sealed.
- Addition or deletion of parking spaces.

NORTHERN ARIZONA UNIVERSITY DESIGN GUIDELINES

- Newly installed or altered or changes to signs (those signs required by ADA, codes and these requirements.)
- Newly installed or altered or changes to accessible routes (those routes required by ADA, codes and these requirements.)
- As per ADA, the term "parking facility" is used instead of the term "parking lot" so that it is clear that both parking lots and parking structures are required to comply.
- Please be advised that all of the above circumstances trigger ADA mandatory requirements. It should also be noted that what some may consider as "only maintenance" may trigger ADA mandatory requirements.

Restriping and new striping: When a new or existing parking facility is striped or re-striped, all work must comply as required by the ADA requirements and applicable codes as well.

Re-striping (without resurfacing or resealing) also requires a permit from the Building Official. The new striping must exactly match the old striping. However, if the old striping and/or the sloped surfaces did not meet the current code and ADA requirements, then the new striping and/or the sloped surfaces will have to be modified to meet current code and ADA requirements. Plans submitted for permits shall identify whether any changes will have to be made to the current striping and/or the sloped surfaces to meet current code and ADA requirements.

Resurfacing and Resealing: Parking facility resurfacing and resealing requires a permit from the Building Official.

Parking Facility Layout: Fire lane requirements may need to be updated. Parking facility layout and aisle widths may be contingent on or determined by fire apparatus access route requirements. The location of fire hydrants shall also not be obstructed. Therefore, prior to striping and/or re-striping of any parking area, the requirements for fire apparatus access routes and location of fire hydrants shall be taken into consideration and approved as determined by the Fire Marshal.

Before allowing striping and/or re-striping of any parking facility on campus, an accessible route must be installed as required by the ADA requirements.

Although not a complete list of ADA scoping and technical requirements, here are a number of items to keep in mind. For a comprehensive and up to date list of requirements, please reference applicable NAU adopted codes and ADA mandatory requirements.

NORTHERN ARIZONA UNIVERSITY DESIGN GUIDELINES

- There is no "grandfathering" for the required number of disabled parking spaces at existing or new parking facilities. The number of accessible spaces required is regulated by the ADA.
- Where more than one parking facility is provided on a site, the number of accessible spaces provided on the site shall be calculated according to the number of spaces required for each parking facility.
- Where parking spaces are marked with lines, width measurements of parking spaces and access aisles shall be made from the centerline of the markings. EXCEPTION: Where parking spaces or access aisles are not adjacent to another parking space or access aisle, measurements shall be permitted to include the full width of the line defining the parking space or access aisle.
- Accessible parking spaces and access aisles are required to be nearly level in all directions, except slopes not steeper than 1:48 shall be permitted for drainage purposes.
- Access aisles shall not overlap with the vehicular way. For safety reasons, it is important that the access aisle not overlap the road or driveway where vehicles could possibly strike the person emerging from their vehicle. This is especially important when parallel parking is provided.
- Two accessible parking spaces shall be permitted to share a common access aisle, and placed on either side of the car or van parking space. Except where van parking spaces are angled, access aisles shall be located on the passenger side of the parking space.
- Access aisles shall adjoin an accessible route. Accessible routes must connect parking spaces to accessible entrances. Accessible routes shall consist of one or more of the following components: walking surfaces with a running slope not steeper than 1:20, ramps and/or curb ramps not steeper than 1:12 (unless very specific exceptions are applicable), etc. In any event, cross slopes shall not be steeper than 1:48. Ramp runs shall always have landings at top and bottom, and in most cases curb ramps will require the same. Handrails and guard rails must also be considered.
- Parking spaces that serve a particular building or facility shall be located on the shortest accessible route from parking to an entrance.
- Where parking serves more than one accessible entrance, parking spaces shall be dispersed and located on the shortest accessible route to the accessible entrances.
- In parking facilities that do not serve a particular building or facility, parking spaces shall be located on the shortest accessible route to an accessible pedestrian entrance of the parking facility.
- Parking spaces shall be permitted to be located in different parking facilities if substantially equivalent or greater accessibility is provided in terms of distance from an accessible entrance or entrances, parking fee,

NORTHERN ARIZONA UNIVERSITY DESIGN GUIDELINES

and user convenience. Factors that could affect "user convenience" include, but are not limited to, protection from the weather, security, lighting, and comparative maintenance of the alternative parking site.

- In residential parking facilities, the requirements differ, therefore please reference Owner's adopted codes and ADA for these particular requirements.

8.4. Plumbing Elements and Facilities

8.4.1. General

- No vestibule (i.e. doors in series) entries into restrooms.
- All gender restrooms shall be accessible for the purposes of privacy and/or assisted use.
- Mirrors shall be full length or no more than 40 inches from floor to bottom of mirror.

8.4.2. Restroom facilities

- Single occupant public/employee restrooms shall be fully accessible.
- Private toilet rooms for employees shall be accessible for approach, entry and exit, and provided with a 5 foot turning radius.
- An all gender restroom shall be provided in all facilities as reasonably feasible (refer to Section 9 of these Design Guidelines for further information)A side approach toilet with a 5 foot turning radius located completely in the compartment shall be provided.
- Toilet paper dispensers shall be located:
 - With the front edge of the dispenser no further than 32 inches from the rear wall of the compartment.
 - Centered 26 inches above the finished floor
 - Below the side grab bar
- Toilet paper dispensers in accessible toilet compartments shall be continuous feed type dispensers; no separate sheet, controlled feed, or large roll dispensers shall be used.
- A coat hook 44 inches above the floor must be provided in the accessible toilet compartment.
- For wheelchair accessible door, door shall open in.
- Latching mechanism for accessible toilet compartment doors shall be operable with a closed fist.

8.4.3. Lavatories and Sinks

- The operable portion of soap dispensers, paper towel dispensers, and electric hand dryers shall be not more than 44 inches above the finished floor.
- Soap dispensers shall be operable with one hand, located within an appropriate reach range, and provided with clear floor space.

NORTHERN ARIZONA UNIVERSITY DESIGN GUIDELINES

- A 29-inch knee clearance shall be provided under accessible sinks. “Extended” sinks (those with a deep front to back dimension) shall not be used to achieve the 29 inch knee clearance.
- Faucet must extend over the sink so there is sufficient space for hands to get wet.
- Adaptable sinks with accessible cabinetry (such as sinks found in employee kitchen areas, laboratories, dwelling units, etc.) shall be provided with a finished flooring surface in the under-cabinet space.

8.4.4. Shower Compartments

- In non-residential conditions, accessible showers shall be:
 - At least 60” X 36” with 60” X 60” being ideal
 - Transfer type entry
 - Provided with padded, fold down bench with integral support legs that extend the full width of the stall and located on the wall opposite of the controls/shower head
 - In communal showers, all the showering areas will be accessible to include hand-held showers, grab bars and fold out shower benches.

8.5. Communication Elements and Features

8.5.1. Assisted Listening Systems

- For ANSI or ADAAG required assisted listening system installations, consult with Owner (Office of Access & Equity) on the appropriate type of system for the building/space.

8.5.2. Emergency “Blue Light” Phones

- Access shall be provided to the emergency “blue light” phones. There should be an accessible approach and clear ground space in front of the phone with a 60 inch turning radius.
- Pedestal mounted emergency “blue light” phone shall be installed such that the center of the speaker is no higher than 48 inches above the surface of the clear ground space.

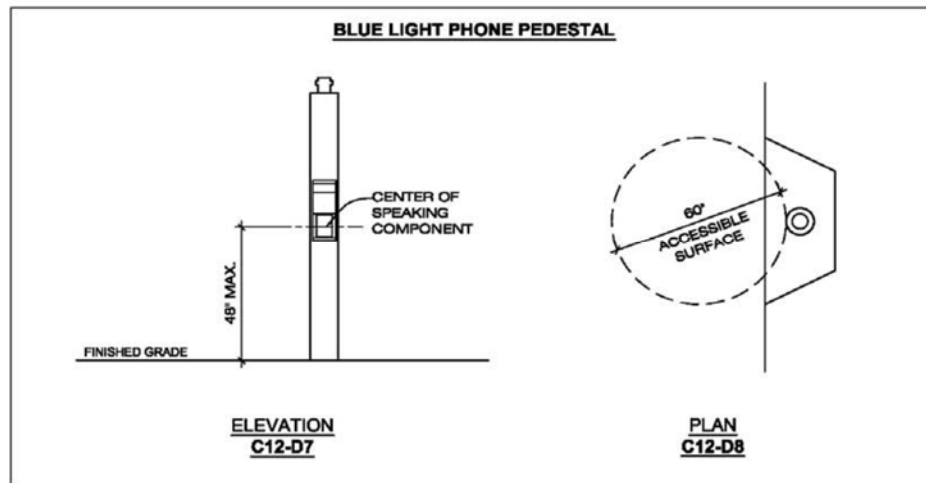

8.6. Rooms and Spaces

8.6.1. Signage

- All permanent rooms and spaces shall be identified with visual and tactile signs mounted 60 inches above the floor on the latch side of the door.

8.6.2. Auditoriums, Classrooms, Tiered Classrooms, and Assembly Areas

- A minimum 10% of total seating shall be accessible.
- Wheelchair accessible seating and companion seats shall be provided in a variety of locations throughout the seating area.
- Wheelchair access shall be incorporated in the primary access route to the stage/teaching station areas.
- In fixed seating situations, seats with fold up arms shall be provided.

8.6.3. Office Spaces

- Each individual office space in new facilities shall have sufficient clear floor space to accommodate a 5 foot turning radius.

8.6.4. Academic Laboratories

- Academic (teaching) laboratories shall be accessible. The accessible work stations shall provide, or have the capacity to provide, those elements of laboratory furnishings and equipment specific to the type of teaching expected to be conducted in the laboratory in question.
- Provide at least one wheelchair accessible workstation in each lab. The workstation shall include:
 - A bench space which is 7 feet long, adjustable in height.

NORTHERN ARIZONA UNIVERSITY DESIGN GUIDELINES

- A sink with faucet controls located on the side with single action lever controls or wrist blade handles.
- Lab gases and power outlets located on the side of the bench or within 18 inches of the front edge of the bench with single action lever controls or wrist blade handles.
- Storage facilities (for lab equipment/materials to be utilized by students in the lab) within ADA reach ranges.
- Where academic laboratories utilize fume hoods, provide at least one accessible fume hood with:
 - An adjustable height work surface.
 - Gas/services within the hood located on the side of the hood or within 18 inches of the front edge of the hood, with single action lever controls or wrist blade handles.
- Eyewashes/safety showers shall be independently accessible and operable by a wheelchair user.
- Aisles 42-48 inches wide are required for accessible benches and fume hoods.
- Where non-laboratory teaching amenities (writing surfaces, lecture areas, etc.) are provided within academic laboratories, at least one accessible workstation which includes such amenities shall be provided.
- Specific purpose teaching facilities (balance or tissue culture rooms, etc.) shall provide a wheelchair accessible space with:
 - A 5-foot diameter radius within one room.
 - An adjustable bench space.

8.6.5. Research Laboratories

- Research laboratories shall have provisions for wheelchair accessibility. The accessible workstation(s) shall provide, or have the capacity to provide, those elements of laboratory furnishings and equipment specific to the type of teaching expected to be conducted in the laboratory in question.
- Individual research laboratory rooms assigned to specific employees are considered employee work areas. For employee work areas, basic access is required for approach, entry, and exit.
- Research laboratory rooms with open assignment workstations/bench space shall be provided with at least one accessible workstation with:
 - A bench space 7 feet long, adjustable in height.
 - A sink with faucet controls located on the side (not rear) with single action lever controls or wrist blade handles.
 - Lab gases and power outlets located on the side of the bench or within 18 inches of the front edge of the bench with single action lever controls or wrist blade handles.
 - Aisles 42-48 inches wide for accessible bench space/hoods.
 - Storage facilities within ADA reach ranges.

- Shared, specific purpose research laboratory rooms in open assignment research laboratories shall be provided with at least one wheelchair accessible workstation/hood with a 5 foot turning radius and an adjustable table.
- Shared fume hoods in open assignment research laboratories shall provide at least one accessible fume hood with:
 - A maximum of 32-inches high work surface with 29-inch clearance below.
 - Gas/services within the hood located on the side of the hood or within 18 inches of the front of the hood, with single action lever controls or wrist blade handles.

8.7. Built-in Furnishings and Equipment

8.7.1. General

- When unfixed furniture may be moved into the path of travel, 42-48-inches aisles for clearance/maneuvering shall be provided.

8.7.2. Seating at Tables, Counters and Work Surfaces

- The top of built-in work surfaces (computer tables, study carrels, etc.) can be of varying heights, but at least 10% of the surfaces must be ADA accessible that blend with the overall space.
- The minimum clearance below built-in furniture shall be 29-inches above finished floor.
- Accessible height service/reception counters 34-inches above finished floor-shall be located at the primary queuing point or staffing location.

8.8. Dwelling Units

8.8.1. General

- Residence halls shall provide all residents and visitors access to all publically available areas of the facility.

8.8.2. Entrances

- All accessible building entrances to residence halls shall be provided with the infrastructure to permit unlocking the doors with a proximity card and permit opening with an automatic door operator.

8.8.3. Paths of Travel

- Stairs and elevators shall be located on a common route within the building.
- Interior doors along the path of travel to accessible rooms and those to building-wide amenities/services (i.e. kitchen, laundry, study/common rooms, etc.) shall be provided with automatic door operators.

NORTHERN ARIZONA UNIVERSITY DESIGN GUIDELINES

- The location of accessible rooms¹ in residence halls shall be:
 - On a convenient path of travel from the main entrance and elevator.
 - Close to building-wide amenities/services.

8.8.4. Doors

- Accessible rooms on all floors of a residence hall shall be provided with the infrastructure for automatic door operators.
- If “peep holes” are provided to residence rooms, provide an additional “peep hole” at 48 inches above the finished floor in the doors of accessible rooms.
- Infrastructure of door knock signalers (i.e. strobes) shall be provided for the entry doors to accessible rooms and the doors to bathrooms attached to accessible rooms.

8.8.5. Bathrooms

- Shower compartments in residential condition accessible bathrooms shall be:
 - Roll in showers
 - A 60” X 60” dimension
 - Provided with a padded, fold down bench with integral support legs installed on the wall adjacent to the controls/shower head.
- Accessible lavatories in residential condition accessible bathrooms shall be provided with counter top space (to accommodate personal care items).

8.9. Codes and Standards

It is the intent and purpose that all construction projects conform to the requirement standards for persons with disabilities as set forth in the 2010 ADA Standards, as adopted by the Department of Justice (DOJ) in September 2010 and their related standards as they apply. Compliance shall conform to the requirements of the latest editions of all state regulations and the various codes which have been adopted by the Owner at the time of bid.

9. ALL GENDER RESTROOM REQUIREMENTS

The Owner is committed to designating and maintaining a minimum of one all gender restroom (AGR) in as many of its buildings as reasonably feasible. Therefore the following criteria should be followed:

9.1. WHERE REQUIRED

- **New Buildings** - A minimum of one AGR shall be provided in each new building.
- **Building Expansions** - Major building expansions should include an AGR unless it is determined that the existing facility has a restroom that can be designated or converted as part of the project scope.
 - If only one AGR can be provided in an existing building, that AGR must meet all ADA code and regulations.
- **Renovations** – For purposes of determining the need of an AGR, renovation projects are defined as those projects involving the alteration of a portion of an existing building. Renovations range from simple aesthetic improvements to complex physical reconfigurations and systems replacement. Due to the potential range of existing conditions – and the ability of a renovation project to address such conditions – it is incumbent that each renovation project undergoes an evaluation early in the design process to outline the scope of compliance which can be achieved.
 - If only one AGR can be provided in an existing building, that AGR must meet all ADA code and regulations.

In general, addition of AGRs should be considered for all projects including minor renovations. For projects where major bathroom renovations are part of the scope, addition of one AGR, should be included. For major renovation projects affecting entire floors or buildings AGRs should be provided if reasonably feasible.

- **Residential Facilities** - Because of the variety of facilities that Owner manages, the Design Professional shall discuss with the Owner specific project requirements and criteria.

9.2. DESIGN CRITERIA

- An AGR consists of a single room with its own door and shall have a privacy latch.
- Accessible AGRs shall not be used as a substitute for providing accessibility to multi-stall restrooms.
- The plumbing fixtures in AGR restrooms shall count towards the total fixture counts required by code. Only one (1) toilet shall be provided.
- In new construction, **all** AGRs must be ADA compliant.
- In new construction, each AGR shall include one (1) baby diaper changing table. ADA clearance is required even with baby changing station down (clear floor space).

NORTHERN ARIZONA UNIVERSITY DESIGN GUIDELINES

- In a renovation where a single gender restroom is converted to an AGR, new construction standards shall be followed.
 - i. If there is only one AGR in a building, it needs to be ADA compliant.
 - ii. If there is more than one AGR in a building, AGRs beyond the first ADA compliant do not have the requirement to be ADA accessible.
- Refer to other sections of these Design Guidelines as applicable for plumbing and bathroom accessory criteria, but at a minimum must follow the following:
 - i. All gender restrooms shall not contain more than one lavatory, and two water closets without urinals or one water closet and one urinal.
- All other applicable codes and regulations shall be incorporated.

9.3. SIGNAGE

All AGRs will be designated as “ALL GENDER RESTROOM” with the following standards:

- There shall be no male or female symbol.
- If the AGR is ADA accessible, the ADA wheelchair symbol shall be used.
- A baby changing station symbol.
- All Gender Restroom in Braille.

Below is a sample of an acceptable sign for the door and the baby diaper changing station:



10. LACTATION ROOM REQUIREMENTS

A lactation room is a non-bathroom space allocated for the privacy of expressing breast milk.

10.1. WHERE REQUIRED

- **New Buildings** - Must have one lactation room.
- **Building Expansions** - Major building expansions should include a lactation room unless it is determined that the existing facility has a room that can be designated or converted as part of the project scope.
- **Renovations** - Due to the potential range of existing conditions – and the ability of a renovation project to address such conditions – it is incumbent that each renovation project undergoes an evaluation early in the design process to outline the scope of compliance which can be achieved.

10.2. DESIGN CRITERIA

- The room shall be fully ADA accessible.
- It shall be a private room, free from intrusion of co-workers, students, the public, etc. This shall be achieved through:
 - SCHLAGE CO-200 Series (code access) on the outside entrance of the room.
 - Ability to lock it from the inside of the lactation.
 - Occupation signage on the outside of the room to indicate if the room is in use or not.
- It shall be located in a safe area accessible to all. It should not be located in areas that would not be suitable for the preparation and storage of food.
- A flat surface or table (not the floor).
- A place to sit (not the floor).
- A sink with hot and cold running water
- A refrigerator
- Access to electricity
- A trash receptacle
- A storage cabinet or locker
- When possible, the design should provide:
 - Soft and/or natural lighting
 - Calming décor

10.3. SIGNAGE

The room shall be designated as “Lactation Room” with braille and the international symbol of accessibility. There shall also be a switch sign to indicate the room is in use. An example is illustrated below.

**NORTHERN ARIZONA UNIVERSITY
DESIGN GUIDELINES**



11. CUSTODIAL PLANNING AND DESIGN

11.1. GENERAL

Custodial services are inherent to the operations of buildings and proper service areas must be considered with all other areas during the programming and planning stages of each building.

Universally accepted standards have yet to be set for custodial closets and storerooms. Certain criteria however, for size, shape, location, and special appurtenances, have been developed which are compatible with present cleaning procedures and today's cleaning equipment.

Comprehensive custodian operations encompass four major areas:

- Custodial closets
- Custodian storage areas
- Recycling and solid waste disposal systems
- Vertical transportation of custodial equipment

11.2. CUSTODIAN CLOSETS

The custodial closets should be planned to function primarily as the workrooms of people responsible for cleaning the interior surfaces of the building. CO-LOCATION OF UTILITIES IS NOT ALLOWED: Telephone switching gear, elevator controls, electric panels water heaters, pipe chases or other service functions are not compatible with custodian operations, and should not be located inside custodian closets. Openings to pipe chases or mechanical equipment areas should also not be located inside custodian closets.

Northern Arizona University has developed the following criteria for custodian closets:

- Size should be a minimum of 92 square feet, with an eight-foot minimum width.
- Recessed light fixtures (to allow for clearance of long broom and mop handles) providing 75-foot candles of light.
- Adequate ventilation for code requirements.
- Pegs for storage of rotary brushes.
- Hangers for wet mops over the sink.
- Hangers and wall space for dust mops and brooms.
- Where a mop sink is needed, the mop sink shall be mounted at floor level.
- Hard surface walls impervious to water at wet walls (i.e. around sinks). Floors of sealed concrete or epoxy flooring.
- Shelves in closet to accommodate supplies in case lots, and to allow for storage of liquids in original 5 or 6 gallon containers. Additional shelving (minimum 11-inches deep) shall be mounted at five-feet high to accommodate light containers and provide clearance for machines storage.

NORTHERN ARIZONA UNIVERSITY DESIGN GUIDELINES

- A 36-inches wide door that swings out, not into the room.
- Reinforced hot and cold water outlets shall be provided with institutional grade hardware and shall be mounted not less than 24-inches above a floor type basin. Basin curb should be 8-inches minimum above the floor.
- A minimum of 5 feet x 2 feet open area to allow for the vacuum unit storage.
- A grounded 20 Amp. Duplex outlet in open wall space, not behind shelves, for recharging battery operated equipment. A minimum of three GFI duplex electrical outlets shall be provided.
- All floors sloped to floor drain at a minimum ¼ inch per foot to the drain
- At least one floor drain for the closet

Location of custodian closets is very important. They should be centrally located with multiple closets as needed so that no area in a building is more than 150 feet in walking distance from a “wet” closet. Each closet should not serve in excess of 15,000 square feet.

Buildings should have custodian closets on every floor. Good locations for secondary custodian closets are:

- Close to elevators
- Close to main pedestrian areas
- Between two restrooms

It is considered poor planning to locate a custodian closet:

- At the dead end of a corridor. A situation such as this results in many unnecessary steps for the custodian.
- On a stair landing. A stair-landing closet would cause the custodian to always carry utensils and equipment up and down stairs.
- Inside another room (unless that closet serves only that room).
- Under stairs. Low ceilings and narrow dimensions are hard to ventilate.
- In narrow spaces. The custodian must move equipment into the hall to utilize a narrow room. Square shaped closets are most efficient.

11.3. CUSTODIAL STORAGE ROOMS

- Every large building should have a storeroom for custodian equipment, bulk supplies and custodian lockers. Buildings larger than 150,000 sq.ft. should contain two such rooms. Storage areas should be designed specifically for custodian storage, not for dual usage. Planning should be done in consultation with those who will be responsible for maintaining the building.
- Locking cabinets should be provided for supplies.
- Dock or elevator facilities must be provided.
- Doors should be no less than 36 inches wide and open out. Storage areas should contain a minimum of 144 square feet. 12 feet x 12 feet are good dimensions.

11.4. RECYCLING AND SOLID WASTE DISPOSAL SYSTEMS

No special waste management rooms or areas are required for gathering or sorting materials.

The design of areas adjacent to the source of recyclable waste generation shall include additional space for collection of recyclable materials as follows:

- Copy Rooms: Paper from copy rooms: 24-inches deep x 22-inches wide minimum
- Common Areas: Newspaper collection bins: 24-inches deep x 22-inches wide minimum
- Vending Areas: Aluminum collection bins: 22-inches deep x 12-inches wide minimum
- Restrooms, break rooms, lounges, and vending areas: Wet waste collection bins: 24-inches deep x 22inches wide minimum

12. CLASSROOM AND OFFICE DESIGN GUIDELINES

This section is divided into the following areas:

	Page
12.1. OVERVIEW	82
12.2. DESIGN REVIEW AND APPROVAL	82
12.3. CLASSROOM SPACE DESIGN	82
12.4. RECOMMENDED TECHNOLOGY ENHANCED FORMAL LEARNING SPACES	100
12.5. OFFICE SPACE UTILIZATION	107

12.1. Overview

The intention of the *Classroom and Office Design Guidelines* is to regard these spaces more judiciously, to ensure that new construction and renovation is planned realistically, efficiently, carefully and conservatively. Promoting optimum use and conservation of these spaces in existing and renovated buildings is imperative to the overall mission of Northern Arizona University. These guidelines are intended to help create a dialog during the early planning process and assist in determining the most important criteria that should be addressed during classroom and office design. It is also important for these guidelines to remain flexible for the needs of Northern Arizona University in the future.

12.2. Design Review and Approval

All classroom and office designs must be approved in writing by Owner (Planning, Design and Construction group [PDC]).

12.3. Classroom Space Design

12.3.1. Classroom Space Utilization

University classrooms are rooms used for scheduled classes that are not limited in their use to a specific subject or discipline. University classrooms include general-purpose classrooms, lecture halls, seminar rooms, auditoriums, and computer classrooms. In the calculation of space utilization, classroom space is defined as the square footage within the walls including the seating area, the circulation space, any instructor/demonstration area, and storage/service area associated with the room.

Utilization of classrooms is defined by the student station size, room use in terms of hours per week, and station/seat occupancy rate. Spaces can vary by academic program depending upon the existing or desired mix of classroom capacities, size of the program, hours of use and types of programs. The station/seat space factor includes an allowance for students, instructor, internal circulation and 5% service. It can vary by room subtypes and type of seating, and depends upon the desired mix of room capacities. Design Professionals

shall consider the geometry of the room, since form can also impact the capacity of the room rendering a less efficient space.

12.3.2. Pedagogy and the Learning Environment

Technological advancements and accessibility of media at a lower cost, and subsequent changes in pedagogy all place demands on the physical space. There is still a need for lecture type rooms where seat count can be maximized by the nature of the learning method (instructor in front with presentation area, rows of seats). Yet, there is also an increasing need for rooms that can accommodate a variety of teaching methods, quick reconfiguration, and technology.

Recent programming exercises for new buildings and subsequent feedback on the use of the current classrooms have rendered the following valuable information:

- Faculty demand for flexible space in classrooms
- Faculty and student demand for collaborative work spaces
- Faculty and student demand for advanced technology classrooms
- Ever increasing demand for special needs student furnishings.

12.3.3. Room Definitions – Space Standards

Different pedagogical techniques require different types of learning spaces. NAU has defined six basic classroom types that are prevalent on its campuses. The recommended square footage requirements reflect the pedagogical style, and take into consideration the diversity of cultural values regarding personal space.

12.3.3.1. Classroom: Traditional, Loose Seating

Traditional classrooms are the most common learning spaces. They have movable furniture, and are very flexible. Furniture can be rearranged to allow for lecture, seminar, group work, or anything else the instructor might require.

- Traditional classrooms contain 25 to 60 non-fixed seats.
- Flat floors are required.
- The first row of student seating should be a minimum of 1.5 times the width of the projection screen from the front of the room. Example: projection screen size 90”H x 120”W, first row of student seating would be 15’-0” from front of room. If not possible to maintain formula outcome, allow a minimum of 9 feet from the front of the room to the first row of seats.
- The instructor’s station is 10 square feet.
- 20 - 22 square feet per student accommodates some collaborative functions.
- 10% of seats must accommodate a left-handed student and should have a variety of locations available throughout the space.

12.3.3.2. Classroom: Traditional/Collaborative

Collaborative classrooms are a subset of traditional classrooms in which the teaching methods require group work. The furniture is movable and flexible.

- Traditional/collaborative classrooms contain 25 - 40 non-fixed seats.
- Flat floors are required.
- 25 - 30 square feet per student accommodates flexibility in furniture arrangement to meet most types of pedagogy.
- Larger, flat work surfaces (sometimes achieved by pushing desks together)
- 10% of seats must accommodate a left-handed student and should have a variety of locations available throughout the space

12.3.3.3. Classroom: Seminar

Seminar rooms generally accommodate smaller numbers of students seated in any number of seating configurations.

- Seminar rooms contain 19 - 25 seats.
- A face-to-face seating arrangement is possible.
- The instructor sometimes sits with students.
- 25 - 30 square feet per student accommodates this type of pedagogy.
- 10% of seats must accommodate a left-handed student and should have a variety of locations available throughout the space.

12.3.3.4. Lecture Halls

Lecture halls are larger tiered classrooms, usually with either fixed seating or fixed tables and movable chairs.

- Lecture Halls contain 50 - 150 seats
- Tiered floors (aisles may be sloped but seating areas must be tiered)
- The dimensions of the seating tier or tray must easily accommodate movement behind seats
- Theater-style seating with attached tablets (preferably retractable) or fixed tables with freestanding chairs.
- A curved configuration is preferred where possible
- 18 - 20 square feet per student overall, but at least 10.5 square feet per students for the seating area, allows for ample circulation amongst the seats.
- The square feet per student ratio is proportionate to the space associated with the podium/front of room, and amount of circulation space required. If the function of the room requires a large stage area or specific circulation pattern, the overall square feet per student may be over guideline.
- 10% of seats must accommodate a left-handed student and should have a variety of locations available throughout the space.

12.3.3.5. Auditoriums

- Auditoriums contain more than 150 seats, with a practical upper limit of around 300
- Aisles may be sloped but all seating areas must be tiered
- Theater-style seating with attached tablets (preferably retractable) are allowed
- A curved configuration is optimum
- 18 square feet per student overall, but at least 6.5 square feet per student in the seating area, allows for ample circulation amongst the seats.
- The square feet per student ratio is proportionate to the space associated with the podium/front of room, and amount of circulation space required. If the function of the room requires a large stage area or specific circulation pattern, the overall square feet per student may be over guideline.
- 10% of seats must accommodate a left-handed student and should have a variety of locations available throughout the space.

12.3.3.6. Computer Classroom

Computer classrooms are specific to the prescribed instruction mode.

- 32 square feet per student accommodates the larger station sizes for equipment and writing space, and generous aisle widths to allow unobstructed instructor movement behind seated students.
- Design for future, and current cabling and electrical requirements.
- Design space for alternative technology set ups:
 - Desktop computer provided where furniture is typically fixed and technology secured, software is necessary.
 - BYO (bring your own) technology where the furniture is flexible and the room supports mobile technology.
- Rooms may need additional HVAC, because of the added heat from numerous machines. This can be reduced if using energy saving designs and software settings.
- 10% of seats must accommodate a left-handed student and should have a variety of locations available throughout the space.

12.3.3.7. Vocational & Laboratory Spaces

Reference the Laboratory Planning & Design section of these Design Guidelines for design specifications for this space type.

12.3.4. General Application

12.3.4.1. Locations

- Classrooms shall be located no more than one floor up or one floor down from the main entrance to the building.

NORTHERN ARIZONA UNIVERSITY DESIGN GUIDELINES

- In such cases, elevator studies must be provided to satisfy movement requirements especially between class changes.
- Classrooms shall be located away from noise generating areas such as mechanical rooms, elevators, vending machines, and restrooms. If physical separation is not feasible, increased acoustical treatments are needed.

12.3.4.2. Hallways/Corridors

- Hallways should not only be part of the building design and aesthetics, but shall be viewed as an extension of the learning environment. They shall always be visually interesting.
- Egress hallways shall be sized to accommodate at least double the loads identified in code due to the large number of students leaving and entering the rooms.
- Gathering space shall be provided in the hallways for in between classes.
- Hallways are an opportunity to improve classroom acoustics.
- Non-recessed doors that open into the hallways are prohibited.
- Hallways are opportunities to incorporate built in seating for waiting space outside of large auditoriums or lecture halls.

12.3.4.3. Informal Interaction Spaces

The design of adjunct teaching/learning space for small or one-on-one collaborative and instructional interaction is encouraged. Small spaces can be incorporated within lobbies, hallways or any other architectural opportunities that might be present.

- **Touch down space:** these can be café height surfaces with a public access computer to briefly check email or to surf the web. Typically, they are not designed to encourage the user to stay for any extended period of time. This can be done by not providing a chair or by providing a high stool.
- **Space for quiet study:** Table space to spread out work, wireless and /or wired internet connection, plentiful outlets for power, comfortable ergonomic furniture, quiet surroundings, appropriate ambient temperature, natural light when possible, and location should be separated from busy areas but not cloistered.
- **Group study area:** Moveable furniture including tables, white board, wireless internet connection, plentiful outlets for power, comfortable, ergonomic furniture, appropriately quiet (no loud HVAC or other environmental noises,) appropriate ambient temperature, natural light when possible, location should be separated from busy areas but not cloistered,.
- **Informal meeting area:** includes areas outside of classrooms where students can continue classroom conversations with faculty: Some degree of privacy for conversations, white board, natural light when possible,

comfortable, ergonomic furniture, appropriate ambient temperature. Ideally these areas should also have power outlets, wireless internet, and either projectors or large display screens to plug into.

12.3.5. Universal Design Considerations

12.3.5.1. Principle One: Equitable Use

The design is useful and marketable to people with diverse abilities.

- Provide the same means of use for all users: identical whenever possible, equivalent when not.
- Avoid segregating or stigmatizing any users.
- Provisions for privacy, security, and safety should be equally available to all users.
- Make the design appealing to all users.

12.3.5.2. Principle Two: Flexibility in Use

The design accommodates a wide range of individual preferences and abilities.

- Provide choice in methods of use.
- Accommodate right- and left-handed access and use.
- Facilitate the user's accuracy and precision.
- Provide adaptability to the user's pace.

12.3.5.3. Principle Three: Simple and Intuitive Use

Use of the design is easy to understand, regardless of the user's experience, knowledge, language skills, or current concentration level.

- Eliminate unnecessary complexity.
- Consistency from one room to the next.
- Be consistent with user expectations and intuition.
- Accommodate a wide range of literacy and language skills.
- Arrange information consistent with its importance.

12.3.5.4. Principle Four: Perceptible Information

The design communicates necessary information effectively to the user, regardless of ambient conditions or the user's sensory abilities.

- Use different modes (pictorial, verbal, tactile) for redundant presentation of essential information.
- Provide adequate contrast between essential information and its surroundings.
- Maximize legibility of essential information.
- Differentiate elements in ways that can be described (i.e., make it easy to give instructions or directions).

12.3.5.5. Principle Five: Tolerance for Error

The design minimizes hazards and the adverse consequences of accidental or unintended actions.

- Arrange elements to minimize hazards and errors: most used elements, most accessible; hazardous elements eliminated, isolated, or shielded.
- Provide warnings of hazards and errors.
- Provide fail-safe features.
- Discourage unconscious action in tasks that require vigilance.

12.3.5.6. Principle Six: Low Physical Effort

The design can be used efficiently and comfortably, and with minimum fatigue.

- Allow user to maintain a neutral body position.
- Use reasonable operating forces.
- Minimize repetitive actions.
- Minimize sustained physical effort.

12.3.5.7. Principle Seven: Size and Space for Approach and Use

Appropriate size and space is provided for approach, reach, manipulation, and use regardless of user's body size, posture, or mobility.

- Provide a clear line of sight to important elements for any seated or standing user.
- Make reach to all components comfortable for any seated or standing user.
- Accommodate variations in hand and grip size.
- Provide adequate space for the use of assistive devices or personal assistance.

12.3.6. Classroom Interiors

12.3.6.1. Design

Classrooms should be developed and designed from the “inside out”. The following items shall be considered when creating a new classroom:

- The optimum orientation and shape of the classroom shall be determined by the primary expected teaching style, the capacity of the room, and the level of mediation.
- Designing for the flexibility of room use is necessary. The more square footage allotted to each student, the greater the opportunity for flexibility.
- The total square footage of each room is to be based on the type of classroom, the specific capacity and the type of seating, as specified in 12.3.3 Room Definitions.
- Classrooms with a capacity of 49 or less are to be as square as possible to allow for greater flexibility in furniture arrangement, and better sight lines.

NORTHERN ARIZONA UNIVERSITY DESIGN GUIDELINES

- Generally, classrooms should be sized in a 2:3 or 3:4 width to length ratio. Long, narrow, “railcar”-style rooms are not acceptable.
- Every seat must have an unobstructed view of the teaching wall. No columns or other visual obstructions are allowed.
- In classrooms where the instructor’s workstation is movable, adequate space must be provided to allow the workstation to be positioned at least three feet away from the teaching wall. In classrooms with fixed tables and/or fixed seating, the front edge of the instructor’s workstation must be at least six feet from the front row.
- Thoughtful placement of utilities (lectern power and data cord, power outlets, room controls, network jacks, etc.) based on anticipated use and room flow patterns may be in the floor, on the walls, or mounted to fixed furniture. Shall be designed with consideration to possible spills, dirt, tripping hazards.

12.3.6.2. Door/Room Security/Floors

12.3.6.2.1. Door Hardware

All classroom doors shall conform to Division 8 of the NAU Technical Standards.

12.3.6.2.2. Doors

- Doors shall be located at the back of the classroom to ensure that students who are entering or exiting the space will not disrupt instruction. Exceptions include large tiered classrooms or auditoriums, since those types of spaces can require multiple doors. In rooms that require two or more egress points, the doors should be located as far from the presentation area as possible while still meeting current building codes.
- Each door leaf to be a minimum of 36” wide, including those used in pairs at double doors.
- No strike mullion on double doors. Where exit double doors require a strike mullion, the mullion must have the ability to be removed.
- Occupancy within the classroom should be clearly (but discretely) visible from the hallway. Any viewing device must be positioned to meet ADA standards. Door shall be equipped with a vision panel made of shatterproof glass and tinted to reduce light transmission. The area of the glass shall not exceed 100 square inches and should be double-paned with acoustically rated seals. Doors without vision panels shall have a sidelight to provide a view into the room to check activity.

12.3.6.2.3. Windows

NORTHERN ARIZONA UNIVERSITY DESIGN GUIDELINES

Daylight is an important part of most learning environments. Windows should be included in classrooms whenever possible. Windows must comply with the “Glass and Glazing” specifications in Division 8 of the Technical Standards.

- For window covering specifications reference Division 12 of the Technical Standards.
- Interior windows shall be considered during the design phase of learning spaces in order to provide a sense of openness.

12.3.6.2.4. Flooring

- When selecting flooring finishes; refer to the specifications in Division 9 of the Technical Standards.
- If carpet cannot be installed underneath fixed seating, all aisles and other open areas must be carpeted.
- All aisle risers must be of contrasting color to the remaining floor to highlight level change.
- Aisle riser nosings are preferred to be vinyl, metal or rubber.

12.3.6.3. Wall and Ceilings

12.3.6.3.1. Walls

- Refer to the specifications in Division 9 of the Technical Standards.
- Internal classroom walls shall run deck-to-deck, with a Sound Transmission Coefficient (STC) rating of 50 minimum.
- Folding or moveable walls must meet the STC rating of 50 and shall be specified for unique use only.
- Walls in lecture halls shall be designed to provide the optimum acoustical environment.

12.3.6.3.2. Walls Protection

- Apply chair rail on the rear and side walls of classrooms that contain movable student furniture.
- Chair rail material shall be wide enough to work with tables and chairs of varying proportions and must be mounted at a height that will prevent damage to wall surfaces. Typically, the chair-rail will be 6” - 10” wide and the bottom edge will start approximately twenty-five inches above the finished floor.
- Rails shall match the design of the room.
- Outside wall corners (such as entry recesses) shall receive corner guards 4'-0” above finished floor (AFF) applied so that students cannot work them loose.

12.3.6.3.3. Ceilings

NORTHERN ARIZONA UNIVERSITY DESIGN GUIDELINES

- Refer to the specifications in Division 9 of the Technical Standards.
- To accommodate classroom lighting and technology requirements, the ceiling height of all classrooms shall be no less than twelve feet above the finished floor.
- In large sloped or tiered classrooms, the ceiling height is directly related to the distance from the front of the room to the last row of seats. Ceilings in lecture halls should be at least nine feet high at the rear, and the ceiling height at the front of the room must accommodate the appropriate screen size.
- The ceiling should act as a sound mirror, reflecting sound downward to blend with direct sound.
- Access for the maintenance of technology, power, etc. must be included where applicable. Running wide low-voltage cable conduits inside the drywall with regularly spaced access points can assist in rewiring.

12.3.6.3.4. Vertical Writing Surfaces

- For specifications for vertical writing surfaces reference Division 10 of the Technical Standards.
- Multiple boards may be required depending on programming.
- Boards should be located on at least two different walls. A board must always be installed on the front teaching wall; the other wall/walls should be selected as appropriate to the layout of the room.
- **NOTE:** Single boards may not be longer than 12 feet (accessibility to classrooms through doors and elevators)

12.3.6.4. Signage

12.3.6.4.1. Room Identification Sign

Each room will have a standard room identification sign mounted near the door on the lockset side (exterior of room), mounted at a height as indicated by the ADA Standards for Accessible Design. Braille lettering is required on the sign to identify the room as well. Standard room ID sign is a modular sign produced by Owner (Paint department) consisting of (3) 3" x 9" panels and (1) 9" x 11" clear plastic page holder. For signage guidelines reference Division 10 of the Technical Standards. Signage needs to be legible from a distance and while moving in the traffic flow. It should be of high contrast and self-explanatory. For

NORTHERN ARIZONA UNIVERSITY DESIGN GUIDELINES

Room Numbering guidelines reference Section 4 of the Design Guidelines.

12.3.6.4.2. Bulletin Boards

- Provide at least one 48" x 48" bulletin board in each room.
- Location and finishes of the bulletin boards will be determined at design.
- The department reserves the right to review all posting and remove anything they deem inappropriate; such as postings for other universities, non-NAU sponsored events & for profit business advertising.

12.3.6.4.3. Maximum Occupancy Sign

Provide maximum occupancy sign to be mounted in rear of room at a height high enough to discourage students from removing it. Size to be 8" x 11" minimum.

12.3.6.5. Colors/Finishes

- Accent walls are desired. Avoid using accent color on walls that might reflect onto projection screen.

12.3.6.6. Reflectance Values

The following reflectance values for finish materials are required:

- Non-accent walls - between 50% and 70%
- Floors - between 20% and 40%
- Ceilings - 80% or higher

Reflectance values of paints, laminate and other finish materials should be selected to enhance ambient illumination and the illumination at the instructor's and student's work areas. Recommended value - between 40% and 60%.

12.3.6.7. Display of US Flag, US Constitution, and US Bill of Rights

In accordance with ARS, "All classrooms in the State of Arizona are to be equipped with a United States flag and copies of the Constitution of the United States and the Bill of Rights." United States flags must be manufactured in the United States and be at least two feet by three feet. Hardware must be specified to appropriately display the United States flag. Flags in classrooms shall be displayed in accordance with Title 4 of the United States Code. The legible copy of the Constitution of the United States and the Bill of Rights must be manufactured in the United States, and shall be displayed adjacent to the flag.

12.3.6.7.1. Flag Location

- Flags should be hung in the front of each room in a holder attached directly to wall.
- The flag should not interfere with the screen, the writing surface, or any other classroom activity.

12.3.6.7.2. Constitution/Bill of Rights

- Install the documents next to the writing surface in the front of each room, behind the instructor, adjacent to the wall mount flag or as appropriate for the layout of the room.

12.3.7. Furniture

Consult Owner for all current furnishing specifications.

12.3.7.1. Tables/Work Surfaces

12.3.7.1.1. Design Standard

- Tables shall provide a minimum of 30" width of space per student. The number of students per table is flexible and is determined by the type of classroom and the configuration of the classroom.
- To allow for note taking and reference materials the minimum work surface area should be 3.75 square feet per occupant.
- Depths of tables can vary from 18"-30" based on room layout.
- Modesty panels are allowed and encouraged when applicable.
- Fixed tables with cantilevered pivot arm seats are not allowed (because they are wheelchair inaccessible). If fixed tables are installed, provide loose seating with casters.
- Furniture must be able to interface with technology (i.e. pathway for power/data), based on Owner technical standards.
- When tablet arms are specified the following criteria must be met:
 - Provided tablet size should be equal to or larger than 12 inch x 15 inch (1.25 square feet).
 - 10% of the tablet work surfaces should have a left-handed orientation or be left-right reversible.

12.3.7.1.2. Construction/Fabrication

- Laminated work surfaces shall be constructed of plastic laminate applied to MDF (Medium-Density Fiberboard) or hardwood plywood. Tops shall have a non-glare, medium tone surface to reduce eye strain.
- The legs of fixed tables should not block the student's knee space within the 30-inch work space allotment. Table legs should not

NORTHERN ARIZONA UNIVERSITY DESIGN GUIDELINES

impede configurations that allow additional students to work collaboratively.

- Table edge to be a heavy-duty extremely durable material.
- Tables to withstand loading of 300 lbs. of applied load (people sitting on table) per linear foot.
- Rounded corners preferred over sharp 90 degree corners.

12.3.7.1.3. Clearances

Widths between aisles of tables to be 36" or greater depending on room layout and number of students serviced per aisle.

12.3.7.1.4. ADA

In cases where fixed tables and loose chairs are used or where fixed seating with tablet-arms is used, adjustable-height ADA tables must be provided.. Ensure that 72" clearance behind table is maintained for access.

12.3.7.1.5. Replacement Availability/Warranty

- Work surfaces/tables shall be procured from vendors approved through the Tri-University furniture Request for Proposal (RFP).

12.3.7.2. Seating

Seating should be selected that will satisfy the requirements of Uniform Building/Fire Codes, durability, functional comfort, appearance/finish, and performance over time. Chairs should accommodate both left and right-handed individuals. Chairs should be comfortable for use by the average-size person.

12.3.7.2.1. Design Standard

When selecting seating in order to achieve minimum standards of comfort, aspects such as width of seat, type of lumbar support, appearance, versatility of seating, replacement availability/ease of maintenance and cost should be considered.

12.3.7.2.2. Seating Width

- The selection of seating width shall be based upon the criteria set forth for the type of seating utilized.
- Seat width comfort will range from 18 to 22 inches for loose seating such as stackers, sled base chairs & chairs with casters (4-leg or star-base).
- Auditorium fixed seat width to be at 24 inches unless restricted by row curve.

12.3.7.2.3. Seating Back Support

All seating shall have proper lumbar support.

12.3.7.2.4. Seating Clearances

To ensure adequate circulation through the learning spaces, minimum clearances must be maintained as previously referenced in these Design Guidelines.

12.3.7.2.5. Appearance

- Light colors are prohibited.
- Upholstered seating is recommended in large auditoriums or lecture halls only where reverberation of sound is a problem.
- The construction and materials should be selected so that their color and surface are consistent with the other furnishing within the classroom and building, and meet the acoustical requirements for the space.
- For material specifications reference Division 12 of the Technical Standards.

12.3.7.2.6. Replacement Availability/Ease of Maintenance and Warranty

- Chairs shall facilitate easy cleaning of the floor surface, and require minimum maintenance of the seat covering (if applicable).
- When casters are specified on seating, ensure that the casters are the correct type for the floor finish (carpet, VCT, etc.).

12.3.7.2.7. Quality

High quality seating shall be specified to minimize the long-term life cycle costs since funding for equipment replacement, repair, and maintenance are becoming increasingly difficult to obtain.

12.3.7.2.8. ADA

All ADA accessible seating in classrooms should comply with ADA Standards for Accessible Design. Owner requires that Universal Design be applied.

- In classrooms with loose tables and chairs, a minimum of 10% of seats are to have height adjustable tables.
- In classrooms or lecture halls with fixed seats with or without tablet arms, minimum required accessible locations to be per 2012 International Building Code.

NORTHERN ARIZONA UNIVERSITY DESIGN GUIDELINES

- In lecture halls with fixed tables and loose seats, the accessible locations are required to have height adjustable tables that coordinate with the fixed tables.

12.3.7.2.9. Versatility

- Fixed seating shall be provided in all large lecture halls, and shall be constructed of cast iron or steel frames. Auditorium seating shall have retractable tablet arms.
- Non-fixed lecture seating requires free-standing chairs with casters.
- In lecture rooms where programs will typically exceed 2 hours, padded seats and backs can be selected and passive ergonomic considerations should be made.
- Fixed auditorium seating may require electrical/data outlets, based on programming needs.
- 10% of seats must accommodate a left-handed student and should have a variety of locations available throughout the space

12.3.7.3. Computer Workstations

Computer workstations are used for teaching methods that require Owner-procured computers/laptops. Computer workstations should accommodate computer equipment, plus the necessary space for student materials.

12.3.7.3.1. Design Standard

- Allow for a minimum surface area of six and one quarter (6.25) square feet to be provided.
- Furniture selection for computer workstations shall have provisions for securing the equipment and the furniture in the room.
- Computer workstation classrooms shall have provisions for increased ventilation and conditioned air supply due to the increased heat load produced by the computers.
- Furniture may be arranged in a row or in collaborative pods.
- ADA tables must be provided according to ADA Standards.
- Computer classroom furniture is an extension of the programming requirement and should conform to the department's needs.

12.3.7.4. Instructor Classroom Furniture Accessories

When providing additional equipment, attempts should be made to maintain aesthetic and functional compatibility with the overall decor of the room.

12.3.7.4.1. Design Standard

For all rooms: Provide an adjustable height, instructor's lectern, a height adjustable table and a stool.

12.3.7.5. ADA

All tables and lecterns must comply with the *ADA Standards for Accessible Design*.

12.3.7.6. Miscellaneous Classroom Items

Reference Division 12 of the Technical Standards. Containers shall not encroach on circulation path.

12.3.7.7. Lighting and Electrical

12.3.7.7.1. Lighting Zones

As a rule, all classroom spaces will have lighting organized into a number of zones. These zones shall be combinable and dimmable to create any number of different lighting scenarios. Classroom lighting shall include multi-modal lighting, controllability, and optimize energy performance. Classrooms should utilize natural light where possible. A room shall be zoned based on the amount of day lighting available, with each fixture responding to the amount of light at any time and location. For lighting specifications, refer to Division 26 of the Technical Standards.

The zones described below are functional zones. There are five functional lighting zones in most classrooms:

Zone 1 — Main classroom lighting (student seating area) this zone services students and allows them to read and take notes in class. Use multi-directional recessed (lay-in) fixtures that cast a modest amount of light downward (35%) and a larger amount of light toward the ceiling (65%), provides a comfortable overall lighting with relatively high efficiency. Avoid pendant mount fixtures.

Zone 2 — Instruction area (front of classroom and lectern area). Design whiteboard and demonstration table lighting to provide visibility when the room lights are at full intensity. The foot candles in this area should be consistent with the overall lighting of the room.

Zone 3 — Non-projection white board (board that is not obscured by a lowered projection screen). Lighting of white boards during concurrent AV presentations allows instructor to write on the board while in projection, without light bleeding over onto the projected image.

NORTHERN ARIZONA UNIVERSITY DESIGN GUIDELINES

Zone 4— Projection white board (board that is obscured by a lowered projection screen) Use the same requirements as Zone 3 during non-projection mode.

Zone 5 — Instructor workstation. The instructor should be able to read notes and use AV equipment with low-light conditions of projection mode

Foot Candle (fc) Guidelines*

	Day Lighting Mode	General Mode/Non-Day Lighting	AV Mode
Student desk	30 fc min 150-200 max	30 f min 70 fc max	10 fc min
Whiteboard	30 fc vertical min	30 fc vertical min	Na
Screen	Na	Na	8 fc vertical allow 8:1 video image with 3000 lumen projector
Walls	10 fc vertical	10 fc vertical	Na

* Based on the “IESNA Lighting Handbook Reference and Application”, Ninth Edition

In larger auditoriums, install a down-light in a location that will provide adequate illumination on the face of the sign language facilitator when the AV mode lighting is in place.

12.3.7.7.2. Emergency Lights

Isolate emergency light radiation away from the projection screen.

12.3.7.7.3. Color Temperature

The color temperature for all light fixtures should be the same. The color temperature goal is 3200 degree Kelvin. Color temperature range of 3000-3500 degree Kelvin is acceptable as long as all of the fixtures are the same.

12.3.7.8. Electrical

For electrical specifications, including outlets refer to Division 26 of the Technical Standards.

NORTHERN ARIZONA UNIVERSITY DESIGN GUIDELINES

12.3.7.8.1. Ceiling Outlets

- Install one AC power quad outlet attached by flexible conduit to a J-box located above the suspended ceiling to allow for the future installation of a data projector, wireless access point, wireless video receiver, etc. This quad should be sited 12'-15' from the screen.
- Design one single-gang data outlet above the ceiling 12'-15' from the screen.
- Provide 120V power capped at a J-box located above the suspended ceiling to allow for the future installation of a low voltage motorized screen controller.

12.3.7.8.2. Floor Outlets

- Provide floor outlets for every classroom to ensure optimum flexibility.
- Floor boxes are to accommodate AV, AC power, data.
- The number of floor outlets is determined by the size of the room, the capacity, and the function. Identify the likely furniture layout before placing outlets.

12.3.7.9. HVAC & Fire Prevention

12.3.7.9.1. Diffuser Location

Diffusers should be located as to avoid any movement of the A/V screens which would be caused by air flow.

12.3.7.9.2. Location of Above-Ceiling Mechanical Equipment

Mechanical equipment that requires service shall not be located within classrooms.

12.3.7.9.3. Noise

Excessive background noise or reverberation in classrooms interferes with speech communication and thus presents an acoustical barrier to learning. In all phases of the classroom design and construction process, careful attention must be paid to acoustics. Locate all mechanical equipment as far from the classroom as possible. If adjacency is unavoidable, provide for sound attenuation methods at doors, light fixtures, and all other ceiling or wall breaches. System components (fans, ductwork & diffusers) shall be selected to meet sound criteria of noise coefficient (NC) NC20 to NC25.

The "ANSI/ASA S12.60-2010 American National Standard Acoustical Performance Criteria, Design Requirements, and Guidelines for Schools

NORTHERN ARIZONA UNIVERSITY DESIGN GUIDELINES

(Parts 1 and 2)” sets specific criteria for maximum background noise and reverberation time in classrooms. Consistent with long-standing recommendations for good practice in educational settings, the standard set specific criteria for maximum background noise (35 decibels) and reverberation time (0.6 to 0.7 seconds) for unoccupied classrooms.

12.3.7.9.4. Fire Alarm Strobes

Locate fire alarm strobes away from projection screen to prevent sightline obstructions of fire alarm strobe when screen is extended.

12.3.7.10. Acoustics

When classrooms are located within close proximity to functions that generate significant noise levels, higher STC ratings and special wall-construction details must be included for all interior walls, elevated slabs, floors and exterior walls (including doors and windows). Provide for sound attenuation to contain noise generated from adjacent locations and from both above and below the classroom location.

- It is the responsibility of the DP to ensure the acoustical requirements are met, which may require services from a separate acoustical consultant.
- Minimum NC ratings: 0-59 seats: NC30-35 or less; 60 to 149 seats: NC 25-30 or less; 150+ seats: NC20-25 or less.
- In all cases, walls in classrooms should have a minimum sound transmission class (STC) of 50 as recommended: ANSI S1.4-1983 (R 2006).
- Individual equipment such as fans, ductwork and diffusers shall have ratings not exceeding NC 25 throughout the load range as recommended: ANSI S12.60-2002.

12.4. Recommended Technology Enhanced Formal Learning Spaces

Every classroom at Northern Arizona University should have a minimum configuration for technology enhancement in order to promote and support pedagogical and technological innovations that increase student engagement, learning, and success. The following recommended standards not only build upon the Owner’s strategic goals, but look into the future as the Owner continues to provide outstanding undergraduate, residential graduate, professional programs, and sophisticated methods of distance delivery.

The following two tiers of technology for classrooms and selected enhancements, adopted as classroom standards, will also assist faculty with their expectations of technology as they consider the learning environment in which they teach, and will allow them to intuitively use the technology provided regardless in which building or department they teach.

NORTHERN ARIZONA UNIVERSITY DESIGN GUIDELINES

All configurations included here are considered to be minimum requirements, and departments may choose to have additional hardware available in individual classrooms.

12.4.1. Equipment

Consistency and standardization of equipment across rooms is very important for ease of training, repair and replacement, and movement between rooms.

12.4.1.1. Tier 1 - Minimum Technology Enhanced Configuration

Note: All AV Control equipment must be Crestron, to facilitate AV Asset Management for NAU.

- A basic push button control system that adheres to ADA accessibility standards **(All Crestron)**
- A lockable lectern that can be adjusted with pneumatic or electronic risers for accessibility. **(EuroDesign Custom Lectern Item #MPD48EAR-NAU-3)**
- 3200+ Lumen Ceiling Mounted Projector **(Hitachi)**
- Podium or Desk rack mounted computer with a 17 inch flat panel display, minimum 4 GB RAM and Core i5 or better processor, Windows 7 or MacOS X. **(at least Dell Optiplex 7020 per NAU Central Standards)**
- Laptop connection with ethernet, VGA (or better, HDMI) output, and stereo sound output
- Video or RCA Composite Video Connection
- Pull Down or Powered Screen
- Tiered (Staged) Lighting (dimmable) around the front projection screen
- Small 20 watt amplifier and speaker system
- Portable microphone for instructor in classrooms with seating for 40 or more students
- Mini stereo plug for iPods and MP3 players
- Dedicated A/C 15amp power for Projector and Instructor Podium/Desk
- Podium task lamp to illuminate presenter materials
- Webcam (either integrated or external)

This configuration of technology includes integrated room control. There will be networking technology for at least the podium computer and laptop, and standard wifi for student connectivity.

12.4.1.2. Tier 2 – Standard Technology Enhanced Classroom Configuration

Everything in Tier 1 and the following:

- Powered Projection Screen **(Dalite Cosmo Electrol)**
- Upgraded to a professionally programmed touch screen control system **(Crestron 3 Series Digital Media Presentation System (200 or 300 as appropriate) and Crestron 7" Touch Panel)**

NORTHERN ARIZONA UNIVERSITY DESIGN GUIDELINES

- Upgraded 4500+ Lumen Projector with power zoom (**Hitachi CP-WU8451 5000 Lumens as appropriate**)
- Multiple projectors, projection screens, or LCD displays for seminar and auditorium classrooms may be useful; ability to display different content or the same content on each screen
- Sound reinforcement to expand reach of instructor voice in large rooms
- Document Camera (**Lumens PS 751**)

Enhancements that will be installed in selected classrooms on an as-needed and strategic basis

- Web Conference room: wireless microphone and podium webcam for use with Bb Collaborate (Secondary camera located in the front of the classroom)
- Video in smaller rooms - two or three plasma or LCD 50" to 80" monitors (quieter than projectors, no bulb replacement costs)
- Shared Room Display (AppleTV, Kramer VIA, AirMeida, etc). Classroom Support currently evaluating enterprise solution.
- Lecture capture appliance or cloud based such as Echo 360 (appliance) or Tegrity (cloud)
- An interactive whiteboard system, such as [eBeam](#), can be used with a normal dry-wipe board to replace the more expensive electronic writing devices used for front projection, such as a SmartBoard or Sympodium

Mobile Computer Labs (Technology Carts) can be used as an alternative to an instructional computer lab when computers are not needed every day. A cart that includes a network printer, wireless access point, and stored laptops that are charged when on the cart, allows the mobile lab to be wheeled into a classroom on a scheduled basis. This also eliminates the need to retrofit a classroom with power and data cables. For more information on Mobile Computer Labs, see the [Learning Spaces Study – Fall 2007](http://jan.ucc.nau.edu/~lrm22/learning_spaces/) (http://jan.ucc.nau.edu/~lrm22/learning_spaces/).

12.4.2. Instructor Station

A standard, approved Lectern should be ordered through EuroDesign: (EuroDesign Custom Lectern Item #MPD3048EA-NAU-R)

Classroom podiums need to allow instructors access to USB and CD/DVD devices along with connecting their own laptop, but should be robust against cable, computer, or peripheral damage. Other A/V equipment may include a microphone, a document/pad camera, and LCD projector controls. Designs with built-in security, such as podiums that house the computer and electrical connections inside a locked (but adequately ventilated) cabinet

NORTHERN ARIZONA UNIVERSITY DESIGN GUIDELINES

with rear access, are a must. A phone in the room with departmental technical support contact information is recommended. Remote management software is also recommended.

When designing the room, it is critical to speak with those who will support and use it. Some instructors may prefer to sit and others will want to move around the room while teaching. Tables with a modified or recessed control panel, and electronics housed separately, are alternatives to the standard podium-style instructor station. A remote (wireless) mouse/slide advancer/laser pointer is essential for those who move around, and is recommended for all classroom instructor stations, need will be determined on a per room basis (as battery life and charging can present problems).

12.4.3. Lighting

Lighting controls for dimming and spot lighting need to be part of the standard installation in all renovations and new classrooms, sufficient to support quality display of projected images.

12.4.4. Windows and window treatments

Windows are not only used for natural lighting, but also for ventilation, and should be part of the design in both formal and informal learning spaces. All external windows should prevent glare by using UV reflective glass or by being retrofitted with a reflective material. Shades should be available on every external window in rooms used for teaching and learning to insure quality image projection. Window cranks should be in working order to provide adequate ventilation and should not prevent the window shade from being closed.

Interior windows should also be considered during the design phase of learning spaces in order to provide a sense of openness.

12.4.5. Network Requirements

Wired data connections are needed at the teaching station area, the projector, and to the fixed student computers if applicable. Wireless networks are considered a supplement to the classroom network. Presently, Owner wireless networks will not provide guaranteed shared multi-user and rich media over a network. Refer to Division 27 Technical Standards for current cable specifications.

12.4.6. Teaching Station

The teaching station or lectern must be height adjustable to meet the needs of any instructor. The teaching station can be wall fed or floor fed through a floor box depending on room size and requirements. When poke-thru devices are not feasible due to structural limitations or costly abatement, use Extron Electronics AVTrac low profile floor-mount raceway system or equivalent. With the proper conduit infrastructure in place, the teaching station can range from a simple table housing a laptop connection to a permanent PC

NORTHERN ARIZONA UNIVERSITY DESIGN GUIDELINES

station offering rack mount equipment, microphone, document cameras, interactive monitor, audience response system, class capture (podcast), and videoconference gear.

12.4.7. Mediation Packages

Owner strives to provide the basic mediation package in each classroom. The level of mediation provided is based on such variables as size and shape of the room, teaching style and discipline-based need. Mediation package options are as follows:

12.4.7.1. Capacity and/or Discipline-Specific Requirements may include:

- Microphones for large capacity rooms (over 40 capacity)
- Document camera
- Assisted listening (over 40 capacity)
- Multiple projectors / screens
- Stereo audio
- Video conferencing
- Class capture
- Class streaming
- Annotative monitor

12.4.7.2. Screens

12.4.7.2.1. Location

- Multiple screens may be required. The type of seating, the capacity, the room configuration and the primary instruction style dictate the optimum number.
- The number of screens required is based on the seating capacity, the configuration of the room, and the primary instruction style.
- Owner recommends angling the screen in the corner of the classroom to both maximize the viewing angle to the audience and increase free whiteboard writing space. Angle-mounting the screen must typically addressed in building planning stages since it usually requires detailing reflected ceiling plan to address ceiling grid and lighting. If angle-mounting the screen is unfeasible, screen placement should still remain opposite from the teaching station area on the teaching wall to maintain whiteboard surface. Ceiling height is also critical when planning the layout of a classroom. Owner recommends a minimum of 12 ft. finished ceiling height to accommodate both lighting and technology.
- Screens should drop no lower than 48 inches from the floor.
- LCD multimedia projectors and motorized projection screens are recommended for use in all classrooms including computer labs, and wet and dry laboratories. Seminar rooms may opt to use LCD

NORTHERN ARIZONA UNIVERSITY DESIGN GUIDELINES

panels for small group presentations, and video conference classrooms are configured as per the specifications set forth in section 12.3 of these Design Guidelines. Large auditoriums and lecture halls may require a secondary manual projection screen which can be used with an overhead projector or pad camera. This screen should be located so that the main screen can be used simultaneously. Two or three motorized screens shall be used in rooms with over 60 student seats.

- LCD projectors shall be mounted from the ceiling and not part of the instructor podium. Selecting an LCD projector that produces adequate lumens for visibility in a well-lit room is important, as is the ability for a projector to be flipped vertically and horizontally to allow for upside down mounting. Lockable security housing that is easy to open for servicing and changing bulbs, and a sturdy ceiling mount, is recommended due to the frequency that projectors are targeted by thieves.
- Window treatments and dimmers for lights above screens should be installed wherever LCD projectors or other document cameras are used for presentation.
- Projection screens and whiteboards should be located so they can be used at the same time. All screens should be installed in front of any lighting fixtures that are used to illuminate whiteboards. Control switches should be visibly accessible, and labeled, for ease of operation. Housing for motorized screen units should be recessed into ceilings with the ability to drop out components of the screen and the motor separately for repair and maintenance.
- Projection screens should align with student seating, the screen mounting heights, and screen sizes at NAU should adhere to the following general guidelines:
 - Align screen so that 45-degree sight lines left and right of the perpendicular centerline cover all student seats within the 90-degree cone.
 - The vertical angle for the front seated viewer to the top of the screen should not exceed 35-degree to floor at student viewing height.
 - A/V designs should include sightline diagrams that verify these requirements. Construction Documents should note angle and dimensions on plan to allow exact placement in field.
 - Screen Mounting Height – Set high and fully recess the housing to keep bottoms of viewing area 48 in. (preferably 72 in.) or greater above floor.

NORTHERN ARIZONA UNIVERSITY DESIGN GUIDELINES

- Screen Size – size screen width to most distant viewer - use a ratio of 1 to 4.
 - Example – 32 ft. to most remote viewer gives an 8 ft. wide screen. Alternatively, the maximum distance to the back row should be 6X image height, and the minimum distance to the front row should be 2x image height.” (Yale University Classroom Design Review Committee, 2007, p. 8).

12.4.7.2.2. Size and Automation

- To calculate the distance from the projection screen to the seats the following formulas are adequate:
 - Minimum distance to front row = 2x the image size
 - Maximum distance to back row= 6x the image size
- All projection screens must be tab-tensioned with aspect ratios of 16:10 to accommodate high definition format.

12.4.8. Writeable Surfaces

Whenever a writing surface is required, an electronic alternative to the whiteboard should be considered. With the availability of electronic presentation equipment in the classroom, blackboards and whiteboards are being used less frequently. Chalkboards are no longer a viable writing surface due to the dust created, and white boards require specialized cleaning chemicals that are irritants to some individuals.

Document cameras are a better alternative to whiteboards and are much easier to see from the back of a larger classroom. Newer and less expensive alternatives to electronic SmartBoards are available. eBeam is one example of a software product that can be installed on a desktop computer and used as it converts any dry-wipe board or any flat surface into an interactive whiteboard and advertises at about half the cost of a SmartBoard.

12.4.9. Wireless Access Points

Enclosure should be required within ceiling- or wall-mounted enclosure dependent upon room layout and ceiling height access.

CAT cabling & POE Ethernet according to Division 27 of the NAU Technical Standards.

12.4.10. Infrastructure

The AV designer is responsible for reviewing the potential cooling load changes with the Owner and Design Professional.

12.4.11. Special Conditions

NORTHERN ARIZONA UNIVERSITY DESIGN GUIDELINES

There may be rooms that will require discipline-based equipment or additional technology, such as media systems, not listed in these guidelines.

12.4.12. Floor boxes and Poke-thru devices

- Poke-thru device to be Wiremold/Legrand 8ATCGY (or equivalent) with the following add-on features (required). Interior Device configuration to include #682A (device plate to accept up to 2 ports of communication devices), #68REC (proprietary 20-amp duplex power receptacle), #8AAP (mounting plate to accept up to 4 Extron AAP Series device plates, & #8ACT6A (mounting plate to accept up to 6 ports of communication devices in any one of 3 gang in the center area). Underside Device Configuration to include #5PTHA (1/2 gang pass through housing assembly), #1PTHA (1 gang pass through housing assembly) & #575CHA (1/2 gang ¼" conduit housing assembly). Cover color to be grey.
- Floor box to be Wiremold/Legrand RFB9 (for retrofit floor cuts) and RFB 11 (pre-construction and where depth permits).

12.5. Office Space Utilization

12.5.1. Office Space Design

12.5.1.1. Square Footage Ranges

The square footage ranges are provided to accommodate the varying programmatic needs of the listed positions. For example, a unit may assign an office on the smaller end of the square footage range to a person who is more likely to spend time working in a research lab than in an office. Conversely, a person may be assigned an office on the upper end of the range to accommodate frequent meetings with multiple individuals.

12.5.1.2. Applying the Guidelines in Shared Spaces

The recommended square footages of shared spaces specify the total amount of office space that should be dedicated to any one person. They do not necessarily indicate the actual size of the office or workspace. For example, a department should designate a cumulative 120-256 square feet for four temporary employees (30-64 square feet per person); this space may or may not accommodate all four persons simultaneously.

12.5.2. Private Offices, Shared Offices and Cubicles

General Guidelines: Color selection and finishes (carpet, wall covering, demountable wall, vinyl base, paint, fabrics and laminates, etc.) must be approved by Owner.

12.5.2.1. Private Offices

NORTHERN ARIZONA UNIVERSITY DESIGN GUIDELINES

The size of the office varies depending on the type of work and the need to meet with individuals or groups frequently and in a private setting. These spaces should be able to accommodate a desk, files, bookshelves, and space to meet with an additional one to six people. The following positions would, in most cases, require private offices:

Executive	Academic	Administrative
President	Dean	Associate or Assistant Vice President
Vice President	Associate or Assistant Dean	Director
	Department Chair	Associate or Assistant Director
	Faculty, Tenure Track	
	Faculty, Research	
	Unit Administrative Manager	

Some positions in a unit or department may require private office space, while a person with similar duties in another unit or department may not. The following positions should be allocated private office space on a case-by-case basis:

Academic	Administrative
Faculty, Non-Tenure Track	Manager
Staff, Professional (Full-time)	Staff, Professional (Full-time)
Faculty, Emeritus (Active)	
Technician, Associate or Specialist (Research)	

12.5.2.2. Shared Offices and Cubicles

Shared offices, cubicles, and open workspaces are an efficient use of office space. Shared offices should be assigned to individuals who require a certain amount of privacy or reduced noise levels. Cubicles and open workspaces are particularly space-efficient, flexible, and can accommodate additional guests as needed. The following positions would, in most cases, be assigned a shared office, cubicle or open workspace

Academic	Administrative
<i>Faculty, Visiting or Consulting</i>	<i>Manager</i>
<i>Research Fellow</i>	<i>Staff, Professional (Full-time)</i>
<i>Fellow, Lecturer, Visiting Scholar</i>	<i>Staff, Administrative Support (Full-time)</i>
<i>Faculty, Emeritus (Non-active)</i>	<i>Staff, Professional (Part-time)</i>
<i>Staff, Administrative Support (Full-time)</i>	<i>Staff, Administrative Support (Part-time)</i>
<i>Staff, Administrative Support (Part-time)</i>	<i>Temporary or Student Staff</i>

**NORTHERN ARIZONA UNIVERSITY
DESIGN GUIDELINES**

<i>Staff, Professional (Part-time)</i>	
<i>Graduate Student Instructor</i>	
<i>Graduate Student Research Assistant</i>	
<i>Temporary or Student Staff</i>	

12.5.3. Space-per-person Recommendations

The following space-per-person recommendations are based on recent construction projects from the Owner and on space guidelines from other higher education institutions and the private sector.

Type of Room Occupants	Space Type	Recommended NASF per Person
Executive		
President	Private Office	400
Vice President	Private Office	300
Academic Units		
Dean	Private Office	240
Associate or Assistant Dean	Private Office	160
Department Chair	Private Office	160
Faculty, Tenure Track	Private Office	100-160
Faculty, Research	Private Office	100-160
Faculty, Non-Tenure Track ¹	Private Office, Shared Office, or Cubicle	80-100
Faculty, Visiting or Consulting	Shared Office or Cubicle	80
Faculty, Emeritus (Active)	Private Office, Shared Office, or Cubicle	64-140
Faculty, Emeritus (Non-active)	Shared Office or Cubicle	30-64
Fellow, Lecturer, Visiting Scholar	Shared Office or Cubicle	80
Unit Administrative Manager	Private Office	100-160
Technician, Associate, or Specialist (Research)	Private Office, Shared Office, or Cubicle	30-100
Research Fellow	Shared Office or Cubicle	30-80
Staff, Professional (Full-time)	Private Office, Shared Office, or Cubicle	64-100
Staff, Professional (Part-time) ¹	Shared Office or Cubicle	80
Staff, Administrative Support (Full-time)	Shared Office or Cubicle	64-100

**NORTHERN ARIZONA UNIVERSITY
DESIGN GUIDELINES**

Staff, Administrative Support (Part-time) ¹	Shared Office or Cubicle	64-80
Graduate Student Instructor	Shared Office or Cubicle	30-64
Graduate Student Research Assistant	Shared Office or Cubicle	30-64
Temporary or Student Staff	Shared Office or Cubicle	30-64
Administrative Units		
Associate or Assistant Vice President	Private Office	160-240
Director	Private Office	100-160
Associate or Assistant Director	Private Office	100-140
Manager	Private Office, Shared Office, or Cubicle	80-140
Staff, Professional (Full-time)	Private Office, Shared Office, or Cubicle	64-100
Staff, Professional (Part-time) ¹	Shared Office or Cubicle	80
Staff, Administrative Support (Full-time)	Shared Office or Cubicle	64-100
Staff, Administrative Support (Part-time) ¹	Shared Office or Cubicle	64-80
Temporary or Student Staff	Shared Office or Cubicle	30-64

¹Part-time denotes the room occupant is 50% FTE or less. If the occupant is more than 50% FTE, it is recommended to follow the guidelines for a full-time room occupant.

12.5.4. General Applications

12.5.4.1. Locations

NORTHERN ARIZONA UNIVERSITY DESIGN GUIDELINES

- Offices should be located to have access to common areas provided for the use of faculty and staff.
- Offices for faculty should be kept near the classrooms used for their associated departments, or near their research labs according to their duty assignments.

12.5.4.2. ADA

Design all offices to comply with ADA Standards for Accessible Design. Owner requires that Universal Design Standards be applied when possible.

12.5.5. Office Interiors

12.5.5.1. Design

The following items should be considered when creating a new office:

- Designing for the flexibility of office space is strongly encouraged. The more provisions made for flexibility, the more options there are for future use of the space.
- The total square footage of each office is to be based on the type of office, the room occupant and the expectations of that position, as specified in Office Types.

12.5.5.2. Door/Room Security

All office doors shall conform to Division 8 of the NAU Technical Standards.

12.5.5.3. Windows

Windows should be included whenever possible. Windows must comply with Division 8 of the Technical Standards.

- If easily accessible, window coverings can be manually operable; otherwise, coverings must be motorized with controls located at the instructor's workstation on the AV touch panel. Where applicable, the depth of the window should be designed to allow for the installation of motorized shade tracks.
- Vertical blinds and drapes are not desired. If necessary, they are to have non-plastic, heavy-duty operating components.
- All window treatments are required to have a non-reflective matte finish and unless otherwise specified, the color selection should match or blend with the window frame.

12.5.5.4. Flooring

- When selecting flooring finishes; refer to the specifications in Division 9 of the Technical Standards.

NORTHERN ARIZONA UNIVERSITY DESIGN GUIDELINES

- Specify an anti-static, high traffic, commercial grade carpet tile. No solid or light colors are permitted.
- A four-inch or six-inch cove base must be included when carpet is specified.

12.5.5.5. Walls and Ceilings

12.5.5.5.1. Walls

- Walls to be painted in accordance with Division 9.
- No wall coverings should be used.

12.5.5.5.2. Ceilings

- The surface of the ceiling must be designed to accommodate the required acoustical properties of the room. Ceiling panels shall have a Noise Reducing Coefficient (NRC) between .65 and .85, and a STC of 50.
- The ceiling should act as a sound mirror, reflecting sound downward to blend with direct sound.
- Ceiling material to be non-sagging (humidity resistant) lay-in acoustical tile for most ceiling areas. Nominal size 24" x 24" or 24" x 48".

12.5.5.5.3. Vertical Writing Surfaces

- Each whiteboard should have a continuous marker tray below each marker board. Do not mount marker holder to wall due to marker bleed ruining wall finish.
- At the top of the whiteboard, a tack board strip and clips for display materials are required.

12.5.5.6. Signage

12.5.5.6.1. Room Identification Sign

Each room will have a standard room identification sign mounted near the door on the lockset side (exterior of room), mounted at a height as indicated by the ADA Standards for Accessible Design. Braille lettering is required on the sign to identify the room as well. Standard room ID sign is a modular sign produced by Owner consisting of (3) 3" x 9" panels and (1) 9" x 11" clear plastic page holder. For Room Numbering guidelines reference Section 4 of the Design Guidelines.

12.5.5.6.2. Bulletin Boards or Tackable Surface

- A tackable surface should be provided in each office.

- Location and finishes of the bulletin boards will be determined at design.

12.5.5.7. Color/Finishes

If an accent wall is incorporated, avoid using accent color on walls that might overpower the room or be unappealing to future occupants.

12.5.5.8. Reflectance Values

The following reflectance values for finish materials are required:

- Ceilings - 80% or higher
- Non-accent walls - between 50% and 70%
- Floors - between 20% and 40%

12.5.6. Furniture

Consult the Owner for all current furnishing specifications.

12.5.6.1. Work Stations

Typical work stations should consist of a desk, return, task chair, 2 desk, storage pedestals, and one bookshelf or storage cabinet.

12.5.6.2. Clearances

Minimum of 36" for egress and path of travel throughout office.

12.5.6.3. Seating

Seating should be selected that will meet minimum passive ergonomic standards and still satisfy the requirements of Uniform Building/Fire Codes, cost, durability, functional comfort, appearance/finish, and performance over time. Chairs should be comfortable for use by average size people.

12.5.6.3.1. Design Standard

When selecting seating in order to achieve minimum standards of comfort, aspects such as width of seat, type of lumbar support, appearance, versatility of seating, replacement availability/ease of maintenance and cost should be considered.

12.5.6.3.2. Task Seating

Shall be ergonomic to include:

- Pneumatic height adjustability
- 5 star caster base

NORTHERN ARIZONA UNIVERSITY DESIGN GUIDELINES

- Adjustable lumbar support
- Adjustable seat depth
- Arms to be height and width adjustable
- Seat width will range from 22 to 25 inches

12.5.6.3.3. Guest Seating

- Seat width will range from 18 to 22 inches.
- If 2 guest seats are provided one should be specified without arms and one with.
- 4 legged chairs with or without casters are preferred.

12.5.6.3.4. Seating Clearances

To ensure adequate circulation through the learning spaces, minimum clearances must be maintained as referenced in Room Definitions.

12.5.6.3.5. Appearance

- The construction and materials should be selected so that their color and surface coordinate with the other furnishing within the office.
- Light colors are discouraged.
- For material specifications reference Division 12 of the Technical Standards.

12.5.6.3.6. Replacement Availability/Ease of Maintenance/Warranty

- Chairs shall be procured from name brand manufacturers that demonstrate proven records of accomplishment in the marketplace, and maintain stock levels that insure replacement can be made without untimely backorder delays.
- Provide written warranty for all proposed furniture. NAU prefers 10 years or longer warranty on all furniture items.
- When casters are specified on seating, insure that the casters are the correct type for the floor finish (carpet, VCT, etc.)

12.5.6.3.7. Quality

High quality seating shall be purchased to minimize the long-term life cycle costs since funding for equipment replacement, repair, and maintenance are becoming increasingly difficult to obtain.

12.5.6.4. Types of Furniture to Avoid

- Furniture not on Tri-University or State contract.
- Furniture that does not meet warranty standards.

12.5.6.5. Miscellaneous Office Items

- Refer to Division 12 of Technical Standards for recycling and trash standards.
- Containers shall not encroach on circulation path.

12.5.7. Lighting and Electrical

12.5.7.1. Lighting Zones

All offices shall have sufficient lighting to provide visibility to the user. Foot Candle Guidelines must be followed for standard offices. For lighting specifications refer to Division 26 of the Technical Standards.

12.5.7.2. Electrical

For electrical specifications, including outlets refer to Division 26 of the Technical Standards.

12.5.8. HVAC & Fire Prevention

For other HVAC and Fire Life Safety specifications refer to Division 23 of the Technical Standards.

12.5.8.1. Location of Above-Ceiling Mechanical Equipment

Access to mechanical equipment for the building will not be located within an office.

12.5.9. Acoustics

Recommendations:

- The review of acoustical requirements for classrooms by an acoustical consultant is recommended whenever possible.
- Minimum NC ratings: 0-59 seats: NC30-35 or less; 60 to 149 seats: NC 25-30 or less; 150+ seats: NC20-25 or less.
- In all cases, walls in classrooms should have a minimum sound transmission class (STC) of 50 as recommended: ANSI S1.4-1983 (R 2006).
- Individual equipment such as fans, ductwork and diffusers shall have ratings not exceeding NC 25 throughout the load range as recommended: ANSI S12.60-2002.

13. LABORATORY PLANNING AND DESIGN

13.1. Overview

The primary objective in this laboratory design guideline is to provide a safe environment for all laboratory personnel to conduct their work including both research and academic use. A secondary objective is to allow for the maximum flexibility. Note that undergraduate teaching laboratories require other specific design considerations. This guide is therefore a resource document intended to be used by faculty, staff, and Design Professionals during the planning and early design phases of a project including both new construction and renovation projects. All health and safety hazards must be anticipated and carefully evaluated so that protective measures are incorporated into the design.

This guide is formatted to address laboratory design issues pertinent to *General Laboratories* (e.g. chemical laboratories) in Section 1, and *Biosafety Level 3 Laboratories* presented in Section 2. Within the sections, specific design criteria are provided. Comments are included under the specific design criterion to give the rationale behind the design feature.

The guide is not all-inclusive as it does not cover all regulatory issues nor does it cover all design situations. It is important to note that specific use practices must be considered during the design process. Owner (Environmental Health and Safety department) should be consulted during the design process to help ensure items regarding health, safety, and code have been addressed.

13.2. General Laboratory Planning

- Utilize a central core for special spaces, shared spaces, and building service areas
- Laboratories should be placed on the perimeter of the building
- Locate offices and circulation spaces between the core and the perimeter labs or on opposite sides of the building from labs
- Maintain safe separation between office spaces and labs
- Maintain adjacency and visibility to labs
- Provide a hierarchy of office spaces that meets Owner's space planning guidelines
- Provide a variety of informal gathering spaces, with tack and marker boards in each
- Maintain all ADA access requirements in both research and teaching labs
- Identify noise and vibration concerns and mitigation thereof
- Consider and discuss merits of lab door recesses with cost
- Incorporate adequate drainage for safety showers
- Incorporate wrist blade faucet handles throughout
- Lab gasses should have wrist blade cock handles
- Identify need for lounges, break rooms, and access to them

NORTHERN ARIZONA UNIVERSITY DESIGN GUIDELINES

- Account for all public restrooms and similar spaces (all-gender and lactation room)
- Separate public corridors with access/code requirements from all research or support corridors
- Discuss security options for access into restricted space (i.e. card or key access)
- Optimize occupant flow into and out of building based on current and future NAU Campus Master Plan
- Public corridors are restricted to people circulation
- “Research and Support” corridors cannot be used as secondary means of egress and used for:
 - Utility distribution
 - Laboratory equipment
 - Chemical deliveries
 - Chemical compounding areas
- Maintain air pressurization through:
 - Sealed lab spaces from adjacent rooms/corridors/building envelope
 - Required pressurization testing during construction (project dependent)
 - Emergency event planning as in loss of power or major equipment failure
- Account for restricted smoke movement both between rooms/corridors and between floors through mechanical chases, doors and stairwells, and elevators
- Required lab hood operation during emergency mode for minimum air flow through hoods while maintaining proper air balance
- Adequate relief of outside air during emergency events
- Appropriate door sweep design/inclusion related to floor flatness requirements
- Air pressurization hierarchies are critical. Ensure all understand design philosophy to be incorporated into project as well as monitoring equipment as necessary with particular attention to limitations of equipment
- Design to include adequate provisions for current and future equipment needs
- Ensure chemical delivery carts have adequate space for parking as well as path of travel
- Recess doors for corridor access from labs where possible/practical
- Identify bulk storage needs and incorporate both within labs and corridor access:
 - Chemicals
 - Gasses
 - Dry Goods
- Millwork to incorporate both secured and unsecured storage
- Coordinate needs and current lock/key requirements with Owner (building occupants and Building Access Services). Note that general lab drawer lock/key systems typically supplied for millwork cabinets and drawers will not be acceptable.
- Incorporate sound isolation as appropriate between labs and between labs or teaching spaces and mechanical rooms

13.3. Laboratory Safety

NORTHERN ARIZONA UNIVERSITY DESIGN GUIDELINES

- Identify appropriate occupancy classification based on assessment of projected chemical inventory of the building, both current needs and future plans
- Design Professionals shall have appropriate professional licenses in area of expertise
- Incorporate appropriate chemical delivery routes and storage based on exposure risks and injury segregating laboratory from non-laboratory activities.
- Identify and incorporate adequate exhaust for all safety storage cabinets, both current and future needs
- Ensure overall security considerations are accounted for
- Incorporate securing regulated materials where applicable (including, but not limited to CDC Select Agents, radioactive materials, and DEA controlled substances)
- Floor must be non-pervious to ensure spills cannot penetrate underneath floors/cabinets.
- Each lab must contain sink for handwashing. BSL3 and above laboratories must have hands-free sink operation. Sinks shall have appropriate screens on drains.
- Chemical storage shelves shall not be placed above laboratory sinks
- Sufficient space or facilities (e.g., storage cabinets with partitions) shall be provided so that incompatible chemicals/gases (waste and non-waste) can be physically separated and stored. This will be based on the chemical inventory and use projection provided by the Owner.
- All labs should be designed to conveniently and safely accommodate the temporary storage of biological, radiological, and chemicals (non-waste and waste) based on laboratory use projections.
- All work surfaces (e.g., bench tops and counters) must be impervious to the chemicals used.
- Design bulk storage areas with appropriate fire resistance ratings for materials and quantities
- Vented cabinets with electrical receptacles and sound insulation shall be provided for the placement of individual vacuum pumps where their use is anticipated. A one- to two-inch hole for the vacuum line hose from the cabinet to the bench top shall be provided.
- Cabinet storage locations may need data and sprinkler connections. Future use considerations should be accounted for
- Conduits into electrical outlets should be sealed for air migration between labs
- Ergonomic considerations should be taken into account for all shelving regarding height and horizontal reach distances
- For renovation projects, all ADA issues are to be addressed
- Chemical hoods are not to be used for storage
- Canopy hoods or snorkels are to be used for heat removal only
- Canopy hoods over autoclaves should be designed as appropriate (i.e. BSL3 and above autoclaves should not be tied into general exhaust)
- All doors must be self-closing
- All doors shall meet required egress pull strengths for normal and emergency conditions
- Storage space for waste must be accounted for
- Eyewash stations must be coordinated with Owner (EH&S) for current requirements
- All lab doors to corridors should provide vision lites

- Fire extinguisher locations shall be coordinated with Owner (EH&S and FLS)

13.4. Biosafety Levels

Not all laboratories present a biohazard condition requiring primary and/or secondary barriers. All BSL2 or above laboratories should be coordinated with Owner (EH&S). Hazards are classified by biosafety level, and required physical barriers are described below. All biosafety level labs must incorporate at a minimum all requirements of lower level labs.

13.4.1. Biosafety level 1

- Handwashing sink, may need hands-free operation depending on use

13.4.2. Biosafety level 2

- Class I or II biosafety cabinets may be required
- Waste decontamination facilities

13.4.3. Biosafety level 3

- Sealing of labs from perimeter areas is essential. All designs shall take into account maintenance aspects to assist in maintaining integrity of rooms sealed from perimeter areas
- Class I or II biosafety cabinets are required
- Glove boxes may be required
- Access control to the laboratory may be necessary and not limited to card readers, cameras, vibration sensors, and motion detectors
- Access considerations may include mechanical equipment locations
- Ventilation must be approved through Owner (EH&S)
- Supply air must be single pass
- Doors may need to interlock
- Building Management System shall be approved by Owner (EH&S) which may include notifications of room pressure losses and/or audible alarms
- Annual testing may be required (case-by-case basis)
- Emergency mode operation must be considered
- Pressure cascade values must be approved by Owner (EH&S)
- All lab equipment, casework, walls, floors, and ceilings must meet current NIH standards for BSL3 or above laboratories
- Special security/access considerations may apply
- All drain designs must be approved by Owner (EH&S)

13.4.4. Biosafety level 4

- Class III biosafety cabinets are required (or personal pressure suit)
- Separate building or completely isolated zone
- Ventilation and waste management systems to contain hazards must be approved by Owner (EH&S)

13.5. Laboratory FF&E

13.5.1. Laboratory Casework

- Provide wood casework
 - Natural finish, no plastic laminate
 - Except where matching existing metal or areas requiring impervious surfaces
 - Animal care areas
 - Biohazard areas
 - Radioisotope areas
 - Chemical storage rooms
- Include utility chase behind wall/peninsula/island base cabinets
- Demonstrate functional usability of corner area where two base cabinets intersect
- Provide removable access panels at knee spaces and sink cabinets
 - Rear stretcher at knee space should be continuous
- Provide pull out writing tablet in casework, using drawer glides
- Provide heavy duty full extension drawer glides (100 pounds minimum)
- Provide pre-fabricated specialty chemical and flammable storage cabinets where required
- Verify specific casework sealing requirements for all BSL3 labs and above
- Verify casework placement does not hinder equipment move-in/out after project completion

13.5.2. Laboratory bench tops

- Epoxy resin tops at all wet or semi-wet areas
- Acid resistant plastic laminate at dry areas
- Provide dished top at all major lab sinks
- Provide lip at all sinks in labs
- Locate seams in tops coincident with seams in benches to allow for modifications
- Tops and curbs shall be non-glaring and black in color.
- Benchtops shall be 1-1/4 inch thick with drip grooves provided on the underside at all exposed edges. Further, all exposed edges, except as indicated below, shall be rounded to a 1/4 inch radius at front top edge and at vertical corners.
- Top set curbs at back and ends of benchtops shall be 4 inch high by 3/4 inch thick, bonded to the surface of the top to form a square joint.
- Sink cutouts shall be smooth and uniform without saw marks and the top edge shall have a uniform radius of approximately 1/8 inch.
- The bottom edge of the sink opening shall be finished smooth with the edge broken to prevent sharpness.
- Corners of sink cutouts shall be radiused not less than 3/4 inch.
- Indented bench tops shall be 1-1/4 inch thick at outer edge, indented 1/4 inch to provide a raised rim 1 inch wide around all exposed edges.
- The front top edge of the raised rim and exposed vertical corners of the top shall be rounded to a 1/8 inch radius.

- The juncture between the raised rim and the top surface shall be covered to a 1/4 inch radius.
- Physical properties:
 - Flexural Strength (ASTM Method 0790-71) - 15,000 PSI
 - Compressive Strength (ASTM Method D695-77) - 35,000 PSI
 - Hardness, Rockwell M (ASTM Method D78-65) - 100
 - Water Absorption (ASTM Method D570-77)
 - % by weight, 24 hours - 0.02
 - % by weight, 7 days - 0.04
 - Specific Gravity - 1.97
 - Tensile Strength - 8,500 PSI
- The benchtops shall be heat resistant and chemical resistant. Chemical resistance testing of the top may result in some discernible change in color or gloss, but no significant impairment of working surface function in life (an evaluation rating of "good" or better).

13.5.3. Wall / peninsula / island reagent shelving (above lab benches)

- Custom fabricated using unistrut-type system (not stock item)
- Extend unistrut from floor through bench top to structure above
- Seal penetration with epoxy seaming material
- Do not use a "wrapped splash"
- Earthquake lip (12" or 18" clear dimension)
- Acid resistant plastic laminate on wood substrate
 - Do not use an epoxy paint or clear finish
- Do not install reagent shelving above sinks

13.5.4. Enclosed wall reagent cabinet (above lab benches)

- 12" clear dimension
- Glass or opaque doors as requested by Users
- Do not install wall cabinets above sinks

13.5.5. Wall shelving (non-reagent)

- Must have backing in wall
- Clear finish wood
- Heavy duty adjustable kv-type brackets
- End caps
- Use unistrut-type reagent shelves for extra deep wall shelving
- Install top-most shelf 24" minimum below
- No wall shelving above sink

13.5.6. Laboratory Equipment and Appurtenances

- Provide a 3'-6" minimum single leaf at each lab/corridor door
- Discuss fume hood selection with Owner
- Investigate special user requirements
 - Laminar flow clean hoods
 - Radioisotope hoods
 - Perchloric acid hoods
 - Biosafety cabinets
 - Laminar flow clean hoods
 - Radioisotope hoods
- Special purpose fume hood with hepa-filtered exhaust discharge
 - Generally uses slightly higher face velocity than conventional fume hoods (125 fpm)
 - Requires welded stainless steel exhaust duct system
 - Can be open or gas-tight (glove box)
- Perchloric acid hoods
 - Straight exhaust duct run (no horizontal offsets) is mandatory
 - Requires automatic wash down system
 - Timer-controlled for washing once per week
 - Discharge must be carried to the lab waste system
 - Requires welded stainless steel exhaust duct system
- Biosafety cabinets
 - Class I biosafety cabinet: 100 fpm, single pass air, out through hepa filter
 - Class II-A biosafety cabinet: 100 fpm, 70% recirculated through hepa, 30% exhaust to room through hepa
 - Class II-B1 biosafety cabinet: 100 fpm, 30% recirculated through hepa, 70% exhausted to exterior through heap. All Class II B2 and above should be welded SS exhaust construction.
 - Class II-B2 biosafety cabinet: 100 fpm, 100% exhausted to exterior through hepa
 - Class II-B3 biosafety cabinet: 100 fpm, 100% exhausted to exterior through hepa, plena under negative pressure to room
 - Class III biosafety cabinet: gas-tight cabinet, supply through hepa, exhaust through 2 hepa

Biosafety cabinet exhausts may be manifolded together, but not with chemical fume hoods. Chemical fume hoods may not be User controllable, must be on 24 hours. Also includes radioisotope and perchloric acid hoods. Consider off-hours setback and vav systems, for energy conservation. Interior recirculation ("supply") fans of biosafety cabinets may be User controllable. All Class II BSCs must be interlocked with hood

and/or general exhaust fans to ensure that operator safety and room pressure are not compromised.

13.6. Laboratory Finishes

13.6.1. Floor finishes

- Choice of floor finish must be approved by Owner
- Vinyl composition tile is appropriate for most labs
- Epoxy sealer is also appropriate for most labs, including chemistry
- Seamless vinyl provides a "pan" in very wet areas. Heat welded flooring may be required in some areas
- Continue flooring under casework
- Seal toekick of all benches (to prohibit water penetration)
- Use topset cove base at toekicks
- Provide epoxy wall paint in all wet labs and on ceilings, if hard surface
- Provide a sealed sleeve with a lip at all floor penetrations

13.6.2. Ceilings

- Suspended acoustical tile ceilings are acceptable in most laboratories
- No ceiling is an option where appropriate
- Provide hard ceilings only where required by lab activity

13.7. Laboratory Utility Service and Distribution

13.7.1. Utilities distribution

- Overhead, in corridor ceiling where possible
- Valve on each utility stub, in corridor
- Shutoff valves must be clearly identified.
- Gas shutoff valves shall be easily accessible for each lab within lab
- Drop on wall surface or freestanding to each lab bench
- Distribute to positions in utility space at rear of casework
- Make joints in horizontal piping only at removable panels
- Visible and accessible
- Consider special delivery systems where appropriate
- Verify waste system requirements with Owner (EH&S)

13.7.2. Utilities on bench tops

- Place turrets toward rear of bench
- Use turrets with angled discharge to enhance hose management
- Utilities racked on reagent shelf
- Generally avoid hoses as they tend to get in the way
- If hoses are planned, rack them on unistrut verticals, not shelves

- Maintain 22" clear height above bench top

13.7.3. Lab sinks

- Confirm with User need for large/deep sinks
- Plan major sinks at ends of benches, in base cabinet
- Use gooseneck faucets with wrist blades at all sinks
- Cup sinks are not routinely needed on benches or in hoods
- Install only if specifically required
- Always provide lip
- In hoods, sink must be at rear to avoid trap being in under-hood storage cabinet
- Include removable lab sink screens for all teaching and research lab sinks

13.7.4. Electrical, lighting, & telecommunications typically required

- Coordinate overall lighting plan with Users and Facility Services
- Provide an adequate number and arrangement of circuits
- Provide an adequate number and arrangement of 120v receptacles
- Provide an adequate number and arrangement of 208v receptacles
- Provide wiremold electrical distribution above all lab benches
- Receptacles above bench must have GFCI protection *within 5' of water source*
- Install of data jacks as required by User in second raceway
- Label each receptacle's circuit
- Alternate circuits in each lab and in each wiremold run
- Provide wall phone jacks where required
- Provide data jacks along benches where required

13.8. Laboratory Air Management Technology

13.8.1. Preferred system

- Building AHUs are to supply make-up air to labs
- Ensure emergency mode makeup air is accounted for when AHU's shut down during emergency conditions (while minimum exhaust flows are maintained in all hoods)
- Identify minimum flow required at all hoods during emergency conditions with Owner (EH&S)
- Ensure access for AHU coil removal/replacement can be achieved without equipment modification
- Lab fan coil units may be used for sensible cooling load of lab equipment
- Investigate manifold and VAV exhaust system if project has many hoods to allow programmed maintenance

13.8.2. Basic system design requirements

- Provide pressure hierarchy between lab spaces

NORTHERN ARIZONA UNIVERSITY DESIGN GUIDELINES

- Identify room pressure/sealing requirements for all lab and corridor spaces including acceptable leakage rates
- Provide capability to measure velocity and pressure downstream of terminal boxes
- Verify exhaust discharge velocity with Owner (EH&S)
- Provide wind study relative to exhaust stack locations and AHU intake locations with all buildings in the immediate area
- Provide bypass on manifold VAV systems at roof or in penthouse where appropriate
- Provide filtration or scrubbing for hazardous emissions
- Verify temperature and humidity controls with Owner
- Design exhaust system for noise reduction
- Discuss BSL3 or above supply and exhaust envelope with Owner prior to implementation
- Noise study and design must account for noise levels in teaching and all research labs. Maximum noise levels must be identified in all labs, both teaching and research

13.8.3. Filtration requirements

- Verify current filter requirements with Owner
- Provide minimum 4" deep 30% efficiency filter banks in 100% outside air systems
- Provide easy removal/replacement of filters

13.8.4. Ductwork materials

- Spiral 316L stainless steel shall be used for fume hood applications
- PVC coated galvanized may be used on manifold VAV systems applications
- Welded 316L stainless steel must be used for perchloric acid hoods and all BSL3 or above exhaust systems

14. LANDSCAPE AND EXTERIORS

14.1. Overview

This section covers **Divisions 2, 3, 32** of the Technical Standards.

ALL EXTERIOR WORK MUST ADHERE TO THE 2015 LANDSCAPE MASTER PLAN AS WELL AS THE APPROPRIATE DIVISION'S TECHNICAL STANDARDS. THE LANDSCAPE MASTER PLAN CAN BE FOUND BY FOLLOWING THE LINK PROVIDED BELOW. IT IS THE CONTRACTORS' AND DESIGN PROFESSIONALS' RESPONSIBILITY TO IDENTIFY IN WRITING TO THE OWNER ANY DISCREPANCIES IDENTIFIED BETWEEN THESE TWO DOCUMENTS THAT MAY ALTER A PROPOSAL OR BID.

2015 LANDSCAPE MASTER PLAN LINK:

http://nau.edu/uploadedFiles/Administrative/Finance_and_Administration/Facility_Services/Documents/DP_Contract/2015%20Landscape%20Masterplan%20Final.pdf

14.2. Existing Conditions

14.2.1. Seismic Investigations

Design Professional shall determine, what seismic requirements are to be followed on this project based on Occupancy Category (A category used to determine earthquake design loads based on the nature of the occupancy) and Seismic Category (A classification assigned to a structure based on its occupancy category and the severity of the design earthquake ground motion at the site as defined in IBC and ASCE 7).) Furthermore, using information such as but not limited to existing site-specific soil conditions provided by a soil or geotechnical engineering investigation, type of foundation system, building structural loads, type of building occupancy, etc. Design Professional shall state the applicable seismic qualification requirements for designated seismic systems on the construction documents.

This topic includes information related to seismic inquiries and investigations required prior to design and performed prior to construction. Seismic investigations survey soil stability to understand soil composition, solidity and quality in addition to determining the depth of soil layers, bedrock and water table. The results define the suitability of land for development, volume of excavation, and structural requirements.

Typically, older projects on NAU Campus had been designed under "Seismic Zones"; and newer projects on NAU Campus are designed under "Seismic Design Categories". As-built construction documents may be available for review upon request from Facility Services. The International Building Code (IBC) classifies structures into *Seismic Design Categories* (SDC): this is different from the older Uniform Building Code (UBC) which classified them into *Seismic Zones*. Seismic Design Categories go much further than merely outlining various

NORTHERN ARIZONA UNIVERSITY DESIGN GUIDELINES

regions of the country. Seismic Design Categories are site specific and include classifications of A, B, C, D, E and F and are based on the following three (3) basic criteria. 1. Probable Site Ground-motion: 2. Soil (Site Class): 3. Building Occupancy Use. The process to determine the Seismic Design Categories must be done by an engineer.

Registered Design Professional shall determine the Occupancy Category: One of the first considerations in the design of any structure starts with determining the occupancy category of the structure. The purpose of determining occupancy category is to set a particular amount by which something is multiplied (or safety factor) in calculating the structural requirements based on occupancy. This requires classification of the occupancy category of any building in accordance with the nature of occupancy as described in the International Building Code or ASCE 7. The occupancy category serves as a threshold for a variety of code provisions related to earthquake, flood, snow and wind loads. Particularly noteworthy are the importance factors that are used in the calculation of design earthquake, snow and wind loads. The value of the importance factor generally increases with the importance of the facility. Structures assigned greater importance factors must be designed for larger forces. The result is a more robust structure that would be less likely to sustain damage under the same conditions than a structure with a lower importance factor. The intent is to enhance a structure's performance based upon its use or the need to remain in operation during and after a design event. The impact of a higher occupancy category classification is not limited to increasing the design loads. Compared to Occupancy Category I, II or III, for instance, an Occupancy Category IV classification can lead to a higher seismic design category classification that can, in turn, require more stringent seismic detailing and limitations on the seismic-force-resisting system. This can also affect the seismic design requirements for architectural, mechanical and electrical components and systems.

Considerations:

The Occupancy Category and Importance Factor are outlined by IBC and ASCE 7 as minimum required guidelines, with the primary intent of protecting the life and safety of the public. This does not necessarily include protecting the aesthetics or functionality of the structure after a severe event. In other words, the structure is designed not to fail, but may endure significant damage (structural or otherwise). This damage may prevent full functionality of the facility after a severe event. This is the reason the code increases the Importance Factor for Occupancy Categories III and IV. A higher Importance Factor improves the reliability (safety factor) of the structure, which helps protect its occupants (School, Buildings with Public Assembly Areas containing greater than 300 occupants), as well as its function (Police, Designated Emergency Shelters), during and after a major environmental event. There may be instances where increasing these parameters above "code minimums" should be considered such as:

- Facilities' ability to function after a major environmental event
- Increased Safety Factor

NORTHERN ARIZONA UNIVERSITY DESIGN GUIDELINES

- Future use of Facility
- Importance factor of closely situated structures, for the purpose of emergency egress and rescue efforts.
- Building design Life Span
- Insurance Carrier Requirements

The desire to increase the Importance Factor should be made aware to the Structural Engineer as early in the project as possible.

Registered Design Professional shall determine the Seismic Design Category:

A classification assigned to a structure based on its *occupancy category* and the severity of the design earthquake ground motion at the site. The seismic design category serves as a trigger mechanism for many seismic requirements, including such as the following:

1. Permissible seismic-force-resisting systems.
2. Limitations on height.
3. Consideration of structural irregularities.
4. The type(s) of lateral force analysis that may be used.
5. The need for additional special inspections.

Registered Design Professional In Responsible Charge of the project shall state the applicable seismic qualification requirements for designated seismic systems on the construction documents that are to be followed on the project. The earthquake load design basis, indicated on the construction documents by the design professional, provides information that allows facilitating the plan review process. All buildings, except those indicated in the IBC exceptions (e.g. Section 1613.1), are to be designed for earthquake effects. The earthquake design data for a specific building are required to meet or exceed the minimum requirements established by NAU adopted codes (e.g. IBC Section 1613.)

14.3. Exterior Improvements

14.3.1. Roads and Parking Lots

Dead end driveways are highly discouraged, but if site restrictions mandate this design approach, there shall be a minimum of 20' of unobstructed pull in length; width equal to the driveway.

The DP is required to obtain all information regarding parking stall layout, flow and stall dimensioning from Owner (Parking & Shuttle Services, NAU Police Department and Access & Equity Office), along with formal written approvals of the design concept from these entities at the completion of the 30%, 60%, and 90% Construction Drawing phases.

15. MECHANICAL, ELECTRICAL, AND PLUMBING DESIGN

15.1. Plumbing

15.1.1. General

All new buildings and building expansion projects shall utilize the campus potable water and sanitary sewer systems see Division 33 for utility standards. Building potable water and sanitary sewer requirement shall be calculated at the programming or schematic design submittals to assure adequate services are available at anticipated connection points. Refinement is expected as design progresses and shall be finalized at the design development stage, with final interconnection requirements identified.

All backflow protection and water supply and sewage connections will comply with the City of Flagstaff building codes and amendments.

Currently, there are seven (7) connections to the City of Flagstaff municipal water supply system.

All service and supply systems, including, but not limited to, domestic water and waste, shall be sized for peak demand throughout the project and shall be sized as far back as the main meter or central distribution system. The adequacy of any central distribution system to carry all added peak loads shall be determined, and no loads shall be connected to any such system that is determined to be undersized.

The use of any electrical source domestic hot water heaters shall not be considered unless a minimum of 20 year life cycle cost analysis of all alternatives is performed. Electrical source equipment shall not be specified unless it is proven to be the most cost effective for the 20 year life cycle. The determination of energy costs must include both consumption and demand charges.

Transformer vaults and electrical rooms shall have no water, waste, storm drain, nor any other pipe conveying water (except fire sprinkler systems required for the vault).

15.2. Campus Energy Infrastructure

15.2.1. North Campus

A central steam generation plant is located in Building 24 on North Campus with a steam supply and condensate systems routed through a subterranean network of tunnels and enclosed pipe chases. Process, domestic, and comfort heating to all new buildings in proximity to the distribution grid is to be provided by the central distribution system. Maximum design steam pressure is 150 psig; design operating conditions are saturated at 60 psig. Heat shall be transferred from the campus distribution system to building hydronic systems via tube in shell heat exchangers. Condensate return is pumped from atmospheric receivers at each building to the plant. Pump discharge pressure varies from 25 psig to 50 psig and must be calculated for each new building system depending on location and head

NORTHERN ARIZONA UNIVERSITY DESIGN GUIDELINES

required. Steam pipe and heating water extensions from the distribution system of greater than 100 LF shall be in walkable tunnels (7 ft x 7 ft minimum). Extensions less than 100 LF may be in enclosed concrete structures, provided reasonable access to serviceable components (i.e. valve expansion joints and drip assemblies) is provided from above, and the lid can be removed to allow pipe replacement. Compensation for thermal stress shall be considered in all steam and condensate pipe design. Pipe stress supporting calculations shall be provided.

A central chilled water production and distribution system is located in building 24 on North Campus with a direct buried supply and return water distribution grid. Process and comfort cooling to all new buildings in proximity of the distribution grid is provided by the central system. The chilled water system is configured as Direct Primary, Variable Flow, with a single set of distribution pumps located within the plant. The central utility pumping is controlled to provide a differential pressure of 15 psig across building piping entry point. Internal building piping and coils shall be designed to meet peak anticipated demands without the use of secondary booster pumps or hydraulic decoupling within the building. Central chilled water supply temperature setpoint in summer time is 42° F. The chilled water supply temperature may be reset upward to 48° F in wintertime to allow use of the plant hydronic economizer. Building coils designed for dissipation of internal winter loads shall accommodate elevated (48° F) chilled water supply temperature. The University prefers that new air handler coils be selected for peak-anticipated design at 42° F with a 20° F degree temperature split. At a minimum, all new building coils (including fan coils) shall be specified to provide a 16° F temperature rise under peak load with 42 F supply. All coils (including fan coils) shall be controlled with two-way valves that modulate based on leaving air temperature.

15.2.2. South Campus

A central high temperature hot water plant is located in Building 67 on South Campus with a heating water supply and return distribution system routed through a subterranean network of tunnels and enclosed pipe chases. Process, domestic, and comfort heating to all new buildings in proximity of the designated grid are provided by the central system. Any modification or extension to the high temperature heating water system shall be designed under ASME piping code for 600 psig pressure and 400° F temperature. The university operates the system at 160 psi, 250° F supply and 210 returns (40 degree split). Heat shall be exchanged from the high temperature loop to the building system via tube in shell heat exchangers, selected to meet peak anticipated building demand with 250° F campus supply and a 40° F temperature split.

A central chilled water production and distribution system is located in Building 67 on South Campus with a direct buried supply and return water distribution grid. Process and comfort cooling to all new buildings in proximity of the distribution grid shall be expanded by the central system. The chilled water system is configured as Direct Primary, Variable Flow,

with a single set of distribution pumps located within the plant. The central utility pumping is controlled to provide a differential pressure of 15 psig across building piping entry point. Internal building piping and coils shall be designed to meet peak anticipated demands without the use of secondary booster pumps or hydraulic decoupling within the building. Central chilled water supply temperature setpoint in summer time is 42° F. The chilled water supply temperature may be reset upward to 48° F in wintertime to allow use of a plant hydronic economizer. Building coil design for dissipation of internal winter loads shall accommodate elevated utility chilled water supply temperature. All building coils shall be specified to provide a 20 °F temperature split under peak load with 42° F supply. All coils shall be controlled with two-way valves that modulate based on leaving air temperature.

15.3. Heating, Ventilation, And Air Conditioning (HVAC)

15.3.1. Local Environmental Conditions

Building design shall account for the ambient environmental conditions in Flagstaff. The Design Professional shall familiarize himself with special altitude and climatic conditions experienced in Flagstaff, and adapt the designs and specifications to suit.

15.3.2. Important considerations for HVAC system designs are:

15.3.2.1. Elevation

All equipment, as appropriate, shall be de-rated for operation at 7,000 feet altitude. Design Professional shall request verification of BTU and specific gravity content of supplied gas in order to specify altitude corrections. Other equipment requiring de-rating includes, but may not be limited to, transformers, motors, fans, blowers and air moving equipment, ducts, controls, atmospheric heat exchangers, and motor speed controls. Motors, variable frequency drives and control equipment enclosures shall be specified to account for altitude effect on temperature dissipation.

15.3.2.2. Design Temperatures

Buildings shall be designed based on the ASHRAE 99% design criteria for Flagstaff. All air handling units with outside air shall be equipped with freeze stats with manual reset, outside air dampers and low-limit controls. All heating water valves shall fail to heating position. Any freeze protection designs shall use -20°F as the minimum temperature.

15.3.2.3. Diurnal Temperature Swing

Mechanical systems shall be designed to accommodate, and respond to, diurnal freeze-thaw cycle of as much as 50° F.

15.3.2.4. Solar Radiation

Characteristics of solar radiation shall be considered under all seasonal conditions. Solar gain effect of low winter sun angle on south facing vertical fenestration shall be evaluated.

NORTHERN ARIZONA UNIVERSITY DESIGN GUIDELINES

15.3.2.5. Design maximum snowfall

Periodic occurrence of snowfall in excess of five feet and potential for drifting snow shall be considered in location of outside air intakes, along with relief and exhaust systems. Use of exterior ducting and equipment is prohibited.

15.3.2.6. Fly snow

Frequent occurrence of light, dry, crystalline "fly" snow shall be considered in design of outdoor air intake ducting and transitions. Baffles, stilling wells and drain pans may be required.

15.3.2.7. Wind Rose, gust velocity and intermittency

Seasonal wind direction shall be considered in location and design of building exhaust, intake, relief louvers and in placement of emergency generator exhaust. Wind gust velocity and intermittency shall be considered in design and location intake and exhaust louvers and of natural ventilation systems.

15.3.2.8. Design Professional Requirements

The Design Professional and consultants shall be responsible for defining the coordination of all systems including but not limited to: electrical systems, control systems, heating and cooling systems, plumbing systems, and any other mechanical systems included in the building design.

15.3.2.9. Hydronic Pumps

All pump motors shall be specified for high efficiency and sizing shall be compensated for altitude. Derating calculations shall be included in the BOD.

15.3.2.10. Steam and Condensate Piping and Pumps

Steam piping design shall include location and detailing of drip legs sufficient to ensure dry steam supplies, and to prevent water hammer.

Steam system design shall be such that use of steam pressure is not necessary to raise condensate through any heat exchanger, or in any area where steam hammer noise will be objectionable.

15.3.3. HVAC Air Distribution

15.3.3.1. Metal Ducts

Owner prefers low pressure, low velocity (2000 FPM max, 2" WC max) air distribution systems. Designs involving higher velocity and/or pressure shall be reviewed and approved in writing by Owner (HVAC Supervisor). Design Professional shall specify acoustic impact for higher velocity systems when requesting a variance.

NORTHERN ARIZONA UNIVERSITY DESIGN GUIDELINES

Noise level volumes of air movement and equipment shall be designed and installed as compatible for intended functions within building spaces. The Design Professional will be held responsible for maintaining acceptable sound levels in all systems.

The design documents shall show locations for all dampers, fire dampers, extractors and other controls. Duct pressure classes are to be shown on duct layout drawings.

15.3.3.2. Supply, Return, General Exhaust

90° bends and offsets in ductwork will be kept to an absolute minimum. When they are required, they will be designed with long radius sweeps to avoid turbulence in the duct.

Design to utilize 45° branch duct entries with main duct size reduction downstream for medium and high velocity systems.

Design to utilize 45° branch duct entries or full conical taps for low pressure ductwork.

Design with 15° convergence and divergence preferred. Absolute maximum of 30° divergence or 45° convergence.

15.3.4. Heating Boilers

All facilities are to be connected to the existing central heating utilities. The use of standalone boilers is allowed only when permitted in writing by Owner. A full life cycle analysis is to be submitted to Owner for evaluation prior to approval. This analysis shall include all expenses including equipment purchase and anticipated replacement costs, maintenance, replacement, and disposal costs, and anticipated costs of energy and water. The efficiency of equipment shall be calculated, and used in the life cycle cost analysis, for all expected load ranges. Rates used in life cycle cost analysis shall be actual demand and consumption costs, not average costs. These can be requested from Owner.

15.3.5. Heat Exchangers for HVAC

Building heat, domestic heat and preheat exchangers shall have 100% redundancy. Dual heat exchangers are required for all applications.

Design physical layout of heat exchangers in building mechanical rooms to provide service access.

15.3.6. Central Cooling Equipment

NORTHERN ARIZONA UNIVERSITY DESIGN GUIDELINES

Mechanical air conditioning systems shall be utilized only when specifically authorized by Owner in writing. Life cycle costing shall be utilized to determine the most appropriate type of cooling or mechanical refrigeration as described in 23 00 00 and below

The selection of the type of air conditioning to be used shall be based on a 15-year life cycle cost analysis of all viable alternatives. This analysis shall include all expenses including equipment purchase and anticipated replacement costs, maintenance, refrigerant handling, replacement, and disposal costs, and anticipated costs of energy and water. The efficiency of equipment shall be calculated, and used in the life cycle cost analysis for all expected load ranges. Rates used in life cycle cost analysis shall be actual demand and consumption costs, not average costs. These can be requested from the Owner.

As a baseline, summertime cooling systems shall have economizer cycles with 100% outside air capability. Enthalpy controls shall be provided on all systems that run continuously. Indirect evaporative cooling shall be considered as an additional capacity system. All central air conditioning systems shall have air-side economizers with enthalpy controls. Wet side economizers shall be evaluated using life cycle cost analysis.

Refrigerant receivers and suction line accumulators shall be used when needed by design. All "critical area" A/C systems shall be redundant or a parts inventory shall be included in close-out submittal requirements to cover emergency repairs. This inventory shall include any and all controls motors or equipment required to make the system operational in an emergency. DP to specify which parts are required.

All outdoor compressor units shall be located under permanent covers. Design Professional shall consider potential of snow drifting or falling icicles in placement of outdoor unit.

15.3.7. Packaged Water Chillers

Systems to be designed with scroll water chillers only when connection to central chilled water service is not possible, when full backup plant redundancy is required, and when with written permission of Owner.

15.3.8. Cooling Towers

Consider noise, wind drift and proximity to outside air intakes when locating cooling towers.

15.4. Electrical

15.4.1. Exterior Lighting

Lighting concepts and recommended illuminance levels per the Illuminating Engineering Society of North America (IESNA) Lighting Handbook and Recommended Practices (latest editions) shall govern the lighting design.

All building entrances shall be illuminated with photocell-controlled luminaires.

NORTHERN ARIZONA UNIVERSITY DESIGN GUIDELINES

All outdoor site lighting shall comply with Flagstaff Lighting Code standards (Flagstaff Zoning Code Chapter 10-50, Division 10–50.70). Particular attention is drawn to the following standards (underlining indicates additional Owner standards, beyond the Flagstaff lighting code standards):

- Total Outdoor Light Output is limited to a maximum of 50,000 initial lamp lm per net acre (cf. 10-50.70.050.C.). For LED fixtures initial “fixture” lumens are to be multiplied by 1.4 for purposes of all calculations involving light, output, including the Total Outdoor Light Output and amber/white light mixing ratios (see below).
- Lighting used for general illumination such as in parking lots, step lighting, etc. must utilize narrow-spectrum amber LED (i.e. AlInGaP LED with peak emission at 590 nm +/- nm, spectral full width to half maximum less than 15 nm). Acceptable LED product numbers include the Philips LXML-PL01 or LXM5-PL01 and Cree XBDAMB. (Note: “phosphor-converted” or “PC” amber LEDs are not acceptable in any applications requiring amber LED.)
- Lighting used for the principal purpose of illuminating pedestrian walkways may utilize mixed sources where a minimum of 90% of the lumens are produced by “narrow-spectrum” or “limited-wavelength” amber LED, mixed with a maximum of 10% of the lumens from white sources such as compact fluorescent, metal halide, or white LED (see below for CCT limits for white lighting). Lighting used for the principal purpose of illuminating roadways, whether or not there are sidewalks adjacent to such roadways, shall follow the standards described below.
- Building entryway lighting and lighting used for interior decks of parking garages may utilize any lamp type, including white sources such as LED, compact fluorescent, or metal halide (see below for CCT limits for white lighting).
- All fixtures used for interior decks of parking garages must be fully shielded. Illumination levels on the interior decks must be 50 lux average maintained or less. Any fixtures located 10 feet or more from the nearest opening to the outdoors do not have their outputs counted toward the Total Outdoor Light Output of the site.
- White (non-LPS, non-amber LED) lighting is limited to 5000 lm per net acre, and must have a correlated color temperature (CCT) of 3000 K or less.

All roadway lighting is exempt from lumens per acre standards of the Flagstaff Zoning Code, but must meet the following standards:

- All fixtures must be fully shielded “narrow-spectrum” or “limited-wavelength” amber LED (see above).
- Illumination on roadways shall not exceed Illuminating Engineering Society of North America (IES) recommended practice for roadways, following illuminance standards, with average maintained illuminance of not to exceed 6 lux and average to minimum ratio of 6 or less. The illumination at any point should not exceed 20 lux. Illumination on roadways with limited vehicular access (such as fire lanes) shall either

NORTHERN ARIZONA UNIVERSITY DESIGN GUIDELINES

be unilluminated, or illuminated to levels based on any other expected uses such as pedestrian walkways.

All sports field lighting is exempt from lumens per acre standards of the Flagstaff Zoning Code, but must meet the following standards:

- All fixtures must be fully shielded
- White light sources are permitted, and must have a correlated color temperature (CCT) of 3000 K or less.
- Illumination levels for the field/track/arena shall be designed to be no higher than recommended for Class IV play, as defined by the current edition of the Illuminating Engineering Society of North America publication IESNA RP-06-01.

Exterior lighting shall be coordinated with physical security, CCTV, and landscaping requirements. Exterior decorative lighting shall not be used for general illumination.

Minimize direct light onto windows; direct and reflective (disabling) glare; and spill illumination onto adjacent properties (use house-side shields when adjacent to residential property). LED lighting is preferred for parking garages.

Include conduits, and mounting provisions in pole bases and on poles, for camera or other security equipment as required. A concrete pull box is to be installed next to the base of each light pole. Street lighting circuits shall be 2" PVC conduits from box to box. Ensure that all wire installed in poles meets the minimum insulation requirements dictated by the voltage present on the lighting circuit. Provide complete pole base details on plans. Details shall indicate complete structural and electrical elements such as rebar, type of concrete, anchors, conduits, handholes etc. Structural elements shall be designed by a licensed structural engineer to meet all local structural conditions, such as seismic zone, soils, wind loading, etc. Coordinate pole locations with snow removal means, and hardscape and landscape features, including projected tree growth.

Provide outdoor, municipal-street-lighting-type control cabinets with a 200amp electrical panel to include a main overcurrent device, branch breakers, control components, stainless steel enclosure mounted on legs, and spare 2" conduits out of pad. Mount controller on a concrete pad, in an unobtrusive location out of the way of snow removal equipment or protected with bollards. Control components to have 3 phase contactors, a photocell with hand off auto switch and contain an electrical meter.

Design professionals must be aware of the impacts of interior lighting visible to the exterior environment through fenestration, particularly large "daylighting" glass surfaces. In general, all light fixtures visible through such fenestration must be fully shielded, and illumination levels in such areas at night must be kept to a minimum, with the guideline of 100 Lux average maintained illuminance or less.

**NORTHERN ARIZONA UNIVERSITY
DESIGN GUIDELINES**

END OF DESIGN GUIDELINES

DIVISION 0 – PROCUREMENT AND CONTRACTING REQUIREMENTS

Section Number	Title
00 00 00	PROCUREMENT AND CONTRACTING REQUIREMENTS
00 01 01	Project Title Page
00 01 15	List of Drawing Sheets
00 10 00	Solicitation/Advertisements and Invitations
00 11 16	Invitation to Bid
00 20 00	INSTRUCTIONS FOR PROCUREMENT
00 21 00	Instructions
00 21 13	Instructions to Bidders
00 21 13.1	Correspondence
00 21 13.2	Sealed Bids
00 21 13.3	Execution of Contract and Bonds
00 21 13.4	Bidding Documents
00 21 13.5	Interpretation or Correction of Bidding Documents
00 21 13.6	Bidder's Representation
00 21 13.7	Bid Period
00 21 13.8	Contractor Qualifications
00 21 14	Bidding Procedure
00 21 14.1	Form and Style of Bids
00 21 14.2	Bid Bond
00 21 14.3	Bidders Qualifications
00 21 14.4	Subcontractors
00 21 14.4.1	Subcontractor List Form
00 21 14.4.2	Subcontractor Bonds
00 21 14.4.3	Subcontractor Insurance
00 21 14.5	Addenda
00 21 14.6	Submittal of Bids
00 22 00	Supplementary Instructions
00 22 11	Drawings and Schedules
00 22 11.1	Complimentary Drawings
00 22 11.2	Interpretation of Drawings and Specifications
00 23 00	Definitions
00 24 00	Scopes
00 24 13	Scopes of Bids
00 24 13.1	Base Scope
00 24 13.2	List of Alternates
00 25 00	Procurement Meetings
00 25 13	Pre-Bid Meeting
00 25 13.1	Pre-Bid Site Inspection
00 25 13.1.1	Supplementary Site Visits
00 26 00	Substitution Procedures
00 30 00	AVAILABLE INFORMATION
00 31 00	Available Project Information

DIVISION 0 – PROCUREMENT AND CONTRACTING REQUIREMENTS

Section Number	Title
00 31 13	Preliminary Schedule
00 31 13.13	Preliminary Project Schedule
00 31 13.16	Preliminary Construction Schedule
00 31 19	Existing Condition Information
00 31 21	Survey Information
00 31 24	Environmental Assessment Information
00 31 25	Existing Material Information
00 31 26	Existing Hazardous Material Information
00 31 31	Geophysical Data
00 31 32	Geotechnical Data
00 31 43	NAU Permit Application
00 31 46	Other Permits
00 40 00	PROCUREMENT FORM AND SUPPLEMENTS
00 41 00	Bid Forms
00 41 13	Bid Form
00 43 00	Procurement Form Supplements
00 43 13	Bid Security Form
00 43 25	Substitution Request Form (During Procurement)
00 43 36	Proposed Subcontractors Form
00 43 83	Proposed Construction Schedule Form
00 45 00	Representations and Certifications
00 45 13	Bidder's Qualifications Contractor Statement of Qualifications (FS#2)
00 50 00	CONTRACTING FORMS AND SUPPLEMENTS
00 52 00	Agreement Forms
00 60 00	PROJECT FORMS
00 61 00	Bond Forms
00 61 13	Performance and Payment Bond Forms
00 61 13.13	Performance Bond Form (FS#4)
00 61 13.16	Payment Bond Form (FS#5)
00 62 00	Certificates and Other Forms
00 62 11	Submittal Transmittal Form
00 62 16	Certificate of Insurance Form (FS#6)
00 62 23	Construction Waste Diversion Form
00 62 34	Recycled Content of Materials Form
00 62 76	Application for Payment Form
00 63 00	Clarification and Modification Forms
00 63 13	Request for Interpretation Form
00 63 19	Clarification Form
00 63 25	Substitution Request Form (During Construction)
00 63 33	Supplemental Instruction Form
00 63 36	Field Order Form

DIVISION 0 – PROCUREMENT AND CONTRACTING REQUIREMENTS

Section Number	Title
00 63 43	Written Amendment Form
00 63 46	Construction Change Directive Form
00 63 57	Construction Change Proposal Request
00 63 63	Change Order Form
00 63 66	Contingency Use Authorization Form
00 63 69	Allowance Use Authorization Form
00 65 00	Closeout Forms
00 65 14	Punchlist Form (FS#24)
00 65 15	Project Inspection Form (FS#15)
00 65 16	Certificate of Substantial Completion Form (FS#81)
00 65 17	Schedule of Required Maintenance Form (FS#88)
00 65 19	Certificate of Final Completion Form (FS#81A)
00 65 19.13	Affidavit of Payment (FS#99)
00 65 19.16	General Contractor Lien Release Form (FS#89)
00 65 19.17	Subcontractor Lien Release Form (FS #84)
00 65 19.19	Consent of Surety to Final Payment Form (FS#87)
00 65 19.19	Final Subcontractor List (FS#82)
00 65 36	Warranty Form (FS#80)
00 70 00	CONDITION OF THE CONTRACT
00 71 00	Contracting Definitions
00 72 00	General Conditions
00 73 00	Supplementary Conditions
00 73 16	Insurance Requirements
00 73 19	Health and Safety Requirements
00 73 34	Affirmative Action for Disabled Workers
00 73 35	Veteran's Preference
00 73 36	Equal Employment Opportunity Requirements
00 73 37	Legal Worker Requirements
00 73 38	Sudan and Iran
00 73 39	Minority Business Enterprise Requirements

Section
Number

00 00 00
00 01 01

Title

PROCUREMENT AND CONTRACTING REQUIREMENTS
Project Title Page

**ARIZONA BOARD OR REGENTS
NORTHERN ARIZONA UNIVERSITY
FLAGSTAFF, ARIZONA**

**PROJECT MANUAL
BIDDING DOCUMENTS AND SPECIFICATIONS
FOR**

PROJECT NAME
NAU PROJECT NUMBER XX.XXX.XXX

DIVISION 0 – PROCUREMENT AND CONTRACTING REQUIREMENTS

Section
Number

Title

00 01 15

List of Drawing Sheets

This section is to be completed by the DP. Labeling of drawing sheets is defined in the DP contract.

DIVISION 0 – PROCUREMENT AND CONTRACTING REQUIREMENTS

Section
Number

Title

00 10 00 **Solicitation – Section to be removed by DP if not needed**

00 10 00 **Advertisements and Invitations**

00 11 16 Invitation to Bid

Sealed bids are being solicited by Facility Services, Office of Planning, Design and Construction, Northern Arizona University, for and on behalf of the Arizona Board of Regents, for the furnishing of all labor, material, transportation and services required for **Project Number: XX.XXX.XXX, Project Name: XXXXXX** on the Campus of Northern Arizona University, Flagstaff, Arizona, in accordance with the plans and specifications on file with Facility Services, Office of Planning, Design and Construction.

Bids will be received at Facility Services, Building #77, Work Control Center, Room 108, Northern Arizona University, Flagstaff, Arizona, until Date and Time . Bids will be opened publicly directly thereafter and read aloud in the Facility Services Conference Room **xx**. A **mandatory** Pre-Bid Conference will be held at date and time in the Facility Services Conference Room **xx**. Plans and Specifications for the proposed work may be inspected online at http://nau.edu/Facility-Services/Bids_RFQ/.

The scope of work for this project is xxxx. A more detailed scope of work is included in the plans and specifications and will be reviewed at the mandatory pre-bid meeting.

All vehicles parking on campus **must** have a permit. Parking permits for the pre-submittal meeting are available at the parking kiosks at the entrances to campus. See <http://nau.edu/parking-shuttle-services/> for more information.

A certified check, cashier's check or NAU Bid Bond Form FS#9 for ten percent (10%) of the amount of bid, must accompany each proposal, as a guarantee that the Contractor will enter into a contract to perform the proposal in accordance with the plans and specifications or as Liquidated Damages in the event of failure or refusal of the Contractor to enter into the contract. Checks or bonds will be returned to the unsuccessful bidders, and to the successful bidder upon the execution of a satisfactory bond and contract, as prescribed by Arizona Revised Statutes.

The Contractor, to whom the contract is awarded, shall, after receipt of Notice of Intent to Award, furnish to the aforesaid Board of Regents a satisfactory performance and payment bond in an amount equal to one hundred percent (100%) of the full amount of the bid, such bond not to be expressly limited as to time in which action may be instituted against the surety company for possible nonperformance of the Contractor. Bonds must be from a corporate surety company licensed to issue surety bonds in the State of Arizona. Individual sureties will not be accepted.

Work shall commence immediately after receipt of an executed contract or a Notice to Proceed and shall be Substantially Complete by date , and shall be Finally Complete by date . Bonds and insurance certificates must be submitted and approved prior to commencement of work.

DIVISION 0 – PROCUREMENT AND CONTRACTING REQUIREMENTS

Section
Number

Title

The Board of Regents reserves the right to reject any or all bids, to waive or decline to waive irregularities in any bid, or to withhold the award for any reason it may determine, and also reserves the right to hold any or all bids for a period of **60** days after the date of the opening thereof. No bidder may withdraw a bid during this **60**-day period without forfeiture of the bid bond.

Women owned and minority owned firms are encouraged to apply. Persons with a disability may request a reasonable accommodation by contacting Facility Services, (928) 523-4227.

ARIZONA BOARD OF REGENTS

Bids should be addressed to:
NAU Planning, Design and Construction
Attention: **Stephanie Bauer**
PO Box 5637
Flagstaff, Arizona 86011
Phone: (928) 523.4227
Facsimile: (928) 523.9441
Email address: **Stephanie.bauer@nau.edu**

Publication Date: **date**

DIVISION 0 – PROCUREMENT AND CONTRACTING REQUIREMENTS

Section Number	Title
00 20 00	INSTRUCTIONS FOR PROCUREMENT
00 21 00	Instructions
00 21 13	Instructions to Bidders
00 21 13.1	Correspondence Address all correspondence relating to the project to: Facility Services Planning, Design, and Construction Attn: Stephanie Bauer Northern Arizona University P.O. Box 5637 Flagstaff, AZ 86011 Stephanie.bauer@nau.edu Reference the Project by both name and NAU project number in all correspondence.
00 21 13.2	Sealed Bids Owner (Northern Arizona University) will receive sealed bids (at the time and place specified in Section 00 11 16, Invitation to Bid) for the labor, equipment and materials necessary to perform all functions and work indicated on the drawings and specified herein. Proposals shall be submitted on the required forms included in Section 00 43 00 of these specifications.
00 21 13.3	Execution of Contract and Bonds The Contract Agreement, which the successful bidder, as Contractor, will be required to execute, is referenced in Section 00 52 00 of this manual. The form of Bonds and insurance certificates required to be furnish are included in Section 00 62 16 of this manual and shall be carefully examined by the bidder. The successful bidder will be required to execute the Standard Form Agreement between Owner and Contractor (Contract) and submit completed bonds and insurance certificates within five (5) working days after Notice of Intent to Award. Failure to execute a Contract Agreement and to file satisfactory payment and performance bonds and insurance certificates issued by companies deemed qualified by the Owner shall be just cause for the cancellation of the Award of Project and the forfeiture of the Bid Bond which shall become the property of the Owner, not as a penalty, but in liquidation of damages sustained. Award may then be made to the next lowest responsible bidder, canceled, or re-advertised as the Owner may elect. Owner reserves the right to waive irregularities in consideration of award to the lowest responsive and responsible bidder.
00 21 13.4	Bidding Documents Bidders may obtain from Owner (Planning, Design, and Construction), a complete set of Bidding Documents stated in the Invitation to Bid, Section 00 11 13 of this document.

Section
Number

Title

Electronic copies of these documents can be found at: http://nau.edu/Facility-Services/Bids_RFQ/.

General Contractors shall be responsible for distribution of bidding documents to Subcontractors.

Complete sets of bidding documents are to be used in preparing Bids. Neither Owner nor Design Professional (DP) assumes any responsibility for errors or misinterpretations resulting from using incomplete sets of bidding documents.

Owner or DP, in making copies of bidding documents available on above terms, does so only for purpose of obtaining bids on the work and does not confer a license or grant for any other use.

00 21 13.5

Interpretation or Correction of Bidding Documents

Bidders shall notify Owner and/or DP promptly of any ambiguity, inconsistency or error discovered upon examination of bidding documents or of site and local conditions. **Failure to so notify Owner/DP is deemed a waiver of any claim by Contractor**, based upon any such ambiguity, inconsistency or errors. The DP shall maintain a log of all inquiries and shall provide written notification of such to Owner (Facility Services Project Manager).

Interpretation, correction or change of bidding documents will be made by written Addendum. Interpretations, corrections or changes of bidding documents made in any other manner will not be binding; Bidders may not rely upon such interpretations, corrections and changes.

00 21 13.6

Bidder's Representation

Each Bidder by making their Bid represents that:

They have read and understand the bidding documents and all Contract Documents and that Bid is made in accordance therewith.

They have visited the site and are familiar with local conditions under which Work is to be performed, including verification of all field measurements, and have inspected all accessible spaces.

They have thoroughly familiarized themselves with all specific products and their proposed uses.

Their bid is based upon the materials, systems and equipment described in the bidding documents without exceptions.

They have satisfied themselves that the products specified are appropriate for the uses proposed.

DIVISION 0 – PROCUREMENT AND CONTRACTING REQUIREMENTS

Section
Number

Title

Their subcontractors with project involvement exceeding \$100,000 are bondable.

They have advised each subcontractor to become thoroughly familiar with the Contract Documents, including the specifications and referenced standards, insofar as they affect each subcontractor.

They will install all Work properly, will place their warranty on the Work, and provide guarantees required.

00 21 13.7

Bid Period

Unless otherwise noted, all bids and bid prices shall remain firm for a period of sixty (60) days after the date of Bid opening and the Contractor shall be prepared to begin construction within ten (10) calendar days of receipt of notice of intent to award.

00 21 13.8

Contractor Qualifications

The Contractor shall submit with bid package the Statement of Qualifications (FS #2) included in Section 00 45 13 of these specifications.

The competency and responsibility of Bidders, of their proposed Subcontractors, and of the Surety issuing the Contractor's performance and payment bonds, will be reviewed prior to award.

00 21 14

Bidding Procedure

00 21 14.1

Form and Style of Bids

Bids must be submitted on Form of Bid (FS#1) provided in Section 00 41 13 of these specifications.

Blanks on the Form of Bid shall be typed in or printed legibly in ink.

Where indicated on Form of Bid, express sums both in words and digits; in case of discrepancy between the two, the written amount shall govern.

Signer of Bid must initial any insertion, alteration or erasure.

Each copy of Bid shall include (on the Contractor Statement of Qualifications - FS #2) the legal name of Bidder and statement whether Bidder is sole proprietor, partnership, corporation or other legal entity. Each copy shall be signed by person, or persons, legally authorized to bind Bidder to a contract. Bid by a corporation shall give the state of incorporation and have corporate seal affixed.

Bid bonds submitted by agent must have current Power of Attorney attached certifying agent's authority to bind Bidder.

Section
Number Title

The list of **required bid forms** is:

1. Form of Bid (FS#1)
2. Contractor Statement of Qualifications (FS#2)
3. Subcontractor List (FS#3)
4. Bid Bond (FS#9)
5. Notification & Confirmation of Asbestos Containing Materials (FS#13)
6. 00 73 38 – Sudan, Iran & Israel

All additional forms that are standard for Owner that must be used throughout the Contract for Construction are noted in Section 00 52 00 and 00 60 00 of these specifications and available through the office of Facility Services, Planning, Design and Construction.

00 21 14.2 Bid Bond
A Certified or Cashier's Check or Bid Bond (NAU form FS#9, see Section 00 43 13) of a corporate surety acceptable to the Arizona Board of Regents, payable to Northern Arizona University for Ten (10%) percent of the amount of the bid, is required as a guarantee that the bidder will enter into the contract if awarded. It shall be declared forfeited as Liquidated Damages if the successful bidder refuses to enter into said contract after being requested to do so by the Arizona Board of Regents/Northern Arizona University.

00 21 14.3 Bidders Qualifications
Bids will be accepted only from those Contractors who are licensed in the State of Arizona and qualified under the laws of the State of Arizona to perform the work specified. All work performed under the Contract by such licensed Contractors must be made to comply with all applicable laws and requirements of any governing bodies or regulatory agencies having jurisdiction over such Work.

The Contractor shall determine that subcontractors are licensed, insured, and qualified to perform their respective work under the contract and shall determine that they are bondable, as required in Section 00 43 36. Each Bidder shall also submit a Subcontractor List (form FS #3 - included in Section 00 43 36 of these specifications) as outlined below in Section 00 21 14.31.

00 21 14.4 Subcontractors

00 21 14.4.1 Subcontractor List Form
In compliance with Contract, the Contractor shall list on the Subcontractor list form provided in Section 00 43 36, the names of **all** qualified subcontractors and/or suppliers he will employ for the various portions of the work indicated for this Project. **All technical sections of this specification** shall be included. Failure to provide complete list of subcontractors (FS#3) may be considered non-responsive. In addition to the general information required on that form, the Contractor shall provide the license number and

DIVISION 0 – PROCUREMENT AND CONTRACTING REQUIREMENTS

Section
Number

Title

class for each subcontractor proposed to do work under the contract. Failure on the part of the Contractor to completely list the names of all anticipated subcontractors will constitute sufficient grounds to reject the bid.

If the Contractor is going to do any portions of the work himself, he shall enter the word "Self" opposite that item in the list; list only one name for each item.

The Subcontractor List must be included inside bid packet. No subcontractor substitutions will be permitted without prior written approval by the Owner.

A complete up-to-date revised list of Subcontractors shall be submitted to the Owner with indications of any work performed by Subcontracting firms classified as minority owned or small businesses, and final contract values, as part of the close-out procedures prior to Final Payment.

The Owner will promptly reply to the Contractor in writing stating if the Owner or the DP, after due investigation, has any objection to any such proposed subcontractor or supplier. The Contractor shall not employ any subcontractor or supplier against whom the Owner or the DP has reasonable objection. If, prior to the award of the Contract, the Owner or DP has a reasonable objection to any subcontractor or supplier and refuses in writing to accept such person or organization, the apparent low bidder may, prior to the award, either withdraw his bid without forfeiture of bid security or may propose an acceptable substitution thereof provided that same results in no change in the bid price. Failure of the bidder to submit an acceptable substitute in a timely manner shall render its bid non-responsive.

No substitution or change shall be made by the Contractor in the subcontractor/supplier list after its submission to the Owner without prior written approval by the Owner. Unapproved or untimely substitutions may be cause for invalidation of the Contractor's bid in the Owner's discretion, thereby rendering the Contract voidable.

All work performed for the Contractor by a subcontractor shall be pursuant to an appropriate written agreement which specifically binds the subcontractor to all applicable terms and conditions of the Contract Documents, but no contractual relationship shall exist between any subcontractor or supplier of any tier and the Owner. Upon request, the Contractor shall provide fully executed copies of any subcontracts and purchase orders to the Owner.

00 21 14.4.2 Subcontractor Bonds

The Owner may require each Subcontractor whose subcontract amount will be \$100,000 or more to furnish payment and performance bonds on Owner's form or on a form approved by Owner, which provides equal or better coverage, for the full amount of its subcontract. These bonds shall be obtained by the Subcontractor as a separate entity and the cost shall be included in the Subcontractor's bid to the Contractor. Bonds will

DIVISION 0 – PROCUREMENT AND CONTRACTING REQUIREMENTS

Section
Number

Title

guarantee the faithful performance of the subcontract and the payment of all obligations thereunder by the subcontractor. The Contractor shall provide Owner with a copy of each required Subcontractor's bond, within fourteen (14) calendar days after the Notice to Proceed is issued by the Owner. Copies of all applicable bonds must be received before processing of the first pay application will occur.

00 21 14.4.3 Subcontractor Insurance

All Subcontractors are required to maintain insurance in force according to the Construction Agreement.

00 21 14.5 Addenda

Any addenda issued by the Owner during the time of bidding shall be considered to be included in the bid, and will become a part of the executed contract. Acknowledgement of receipt of Addenda shall be made on the Form of Bid (FS #1) in the space provided.

Final Addenda shall be issued a minimum of **three (3)** days prior to the bid date.

If a Bidder should fail to receive any addendum, or should fail to acknowledge receipt of same, the Bidder shall have the option of accepting a contract, if offered, including all addenda, at the Bid price, or withdrawing the bid without penalty. NAU and/or the DP are not responsible for ensuring delivery of addenda to any Bidder. Failure to receive addenda or failure to acknowledge receipt shall not constitute a basis for claim, protest, or re-issue of the invitation to bid.

00 21 14.6 Submittal of Bids

Copies of the Form of Bid (FS#1), Bid Bond (FS#9) or Certified Check or Cashier's Check for ten percent of the amount of the bid, Subcontractors List (FS#3), and other documents required to be submitted with Bid per Section 00 43 13 (see required forms, Section 00 43 13) shall be enclosed in sealed, opaque envelope. Address envelope to Facility Services, identifying project name, Bidder's name and address.

If Bid is sent by mail to **PO BOX 5637, Flagstaff AZ, 86011**, a sealed envelope shall be enclosed within a separate mailing envelope with "BID ENCLOSED" and identification of the Project and date and time for bid opening plainly indicated on the face thereof.

Bids must be received at the designated location prior to time and date for receipt of Bids indicated in advertisement. If received after the time and date for receipt of Bids, or any extension thereof made by Addendum, the bid package will be returned unopened.

Bidder assumes full responsibility for timely delivery of bids. Bids sent by mail that have not been delivered to Facility Services, Building 77, Work Control Center, Room 108 by the designated time of the bid opening will not receive consideration; including specifically, but not limited to, bids received by NAU Post Office but not delivered to the bid opening location.

DIVISION 0 – PROCUREMENT AND CONTRACTING REQUIREMENTS

Section
Number

Title

Electronic, oral, telephonic, FAXES, or telegraphic Bids are invalid and will be considered non-responsive.

00 22 00 **Supplementary Instructions**

00 22 11 Drawings and Schedules

00 22 11.1 Complimentary Drawings

Upon award of Contract, the Contractor will be furnished any available sets of Plans, Specifications, and project manuals, if any. Additional sets may be printed from: http://nau.edu/Facility-Services/Bids_RFQ/ .

00 22 11.2 Interpretation of Drawings and Specifications

The Contractor shall study and compare the Contract Documents sufficiently in advance of bidding the work to be performed and immediately report any material error, inconsistency, conflict, ambiguity, or omission that is discovered.

The Contract Document specifications for the applicable Contract in use can be found at http://nau.edu/Facility-Services/DP_Contract/

The Drawings are intended to show general arrangements, design and extent of Work and are not intended to serve as Shop Drawings. Where required, the Contractor shall perform no portion of the Work without approved Shop Drawings, Product Data or Samples; any Work performed in violation of this provision will be solely at the Contractor's risk regardless of DP's and/or Owner's knowledge of such Work.

Contract Documents shall be interpreted as being complementary, requiring a complete project or designated portion thereof. Generally, the specifications address quality, types of materials and contract conditions while the drawings show placement, sizes, and fabrication details of materials. In the event of conflict in the Contract Documents, the priorities stated below shall govern:

- A. Addenda shall govern over all other Contract Documents;
- B. Subsequent addenda shall govern over prior addenda, but only to the extent modified;
- C. In case of conflict between drawings and specifications, the specifications shall govern;
- D. Conflicts within the plans:
 - (1) Schedules, when identified as such, shall govern over all other portions of the plans.
 - (2) Specific notes shall govern over all other notes and all other portions of the plans, except the schedules described in 00 22 11.2 D (1) above.
 - (3) Larger scale drawings shall govern over smaller scale drawings.
 - (4) Figured or numerical dimensions shall govern over dimensions obtained by scaling.
- E. Conflicts within the specifications:

DIVISION 0 – PROCUREMENT AND CONTRACTING REQUIREMENTS

Section
Number

Title

Contract General Conditions shall govern over all sections of the specifications except for specific Modifications thereto that may be stated in Supplementary General Conditions or addenda. No other section of the specifications shall modify the Contract General Conditions.

- F. In the event provisions of codes, safety orders, Contract Documents, referenced manufacturer's specifications or industry standards are in conflict, the more restrictive or higher quality shall govern.
- G. In the event of any conflict or ambiguity, the Contractor shall request an interpretation by the DP before performing the Work.
- H. In the event of any conflict between the Specifications and Northern Arizona University Technical Standards, the Contractor shall notify the Owner for direction prior to bid. Otherwise the more restrictive or higher quality shall govern.

If the Contract Documents are not complete as to any minor detail of a required construction system or with regard to the manner of combining or installing of parts, materials, or equipment, but there exists an accepted trade standard for good and skillful construction, such detail shall be deemed to be an implied requirement of the Contract Documents in accordance with such standard.

“Minor detail” shall include the concept of substantially identical components, where the price of each such component is small even through the aggregate cost or importance is substantial, and shall include a single component which is incidental, even though its cost or importance may be substantial.

The quality and quantity of the parts or material so supplied shall conform to trade standards and be compatible with the type, composition, strength, size, and profile of the parts or materials otherwise set forth in the Contract Documents.

00 23 00

Definitions

Definitions set forth in General Conditions of the Standard Form Agreement Between Owner and Contractor, or in other Contract Documents are applicable to Bidding Documents. Definitions below are in addition to the definitions of the Contract Documents and are not considered a replacement.

Alternate Bid(s): A sum stated in addition to the Base Bid for which Bidder offers to perform Work described as the alternate. The Owner may select all, none or any combination of alternates.

Approved: Where used in conjunction with the DP’s response to Submittals, requests, applications, inquiries, reports and claims by the Contractor, the meaning of the term "approved" will be held to the limitations of the DP’s responsibilities and duties as specified in the General and Supplementary Conditions. In no case will "approval" by the DP be interpreted as a release of the Contractor from responsibilities to fulfill the requirements of the Contract Documents.

DIVISION 0 – PROCUREMENT AND CONTRACTING REQUIREMENTS

Section
Number

Title

Base Bid: A sum stated in the Bid for which Bidder offers to perform Work described as base, to which Work may be added or deducted for sums stated in Alternate Bid(s).

A Bid is a complete and properly signed proposal to do the Work or designated portion thereof for some stipulated sum therein supported by data required in Bidding Documents.

Bidder: One who submits a Bid for prime Contract with Owner for Work described in the Contract Documents.

Bidding Documents: Include Advertisement for Bids, Instructions to Bidders, Bid Form, other bidding and Contract forms and Contract Documents including Addenda issued prior to receipt of bids.

Contract Documents: Are further defined per Agreement at the following link: http://nau.edu/Facility-Services/DP_Contract/, and also include, but are not limited to, the Agreement, amendments, change orders, these Design-Builder General Conditions, any supplementary or special conditions referenced in the Agreement and any other items stipulated to as being included in the Contract Documents, including the complete design as accepted by the Owner.

Furnish: Except as otherwise defined in greater detail, the term "furnish" is used to mean supply and deliver to the project site, ready for unloading, unpacking, assembly, installation, etc., as applicable in each instance.

Install: Except as otherwise defined in greater detail, the term "install" is used to describe operations at the project site including unloading, unpacking, assembly, erection, placing anchoring, applying, working to dimension, finishing, curing, protection, cleaning and similar operations, as applicable in each instance.

Installer: The entity (person or firm) engaged by the Contractor or its subcontractor or sub-subcontractor for the performance of a particular unit of work at the project site, including installation, erection, application, cleaning and similar required operations.

Provide: Except, as otherwise defined in greater detail, the term "provide" means furnish and install, complete and ready for the intended use, as applicable in each instance.

Work: Is comprised of all activities (including design, other related services and construction activities) required to complete the Project as defined by the Project Criteria and Contract Documents, including procuring and furnishing all materials, equipment, services, and labor reasonably inferable from the Contract Documents, or from prevailing trade usage and custom.

DIVISION 0 – PROCUREMENT AND CONTRACTING REQUIREMENTS

Section Number	Title
00 24 00	Scopes
00 24 13	Scopes of Bids
00 24 13.1	Base Scope <i>The DP shall insert in this section a detailed description of the base scope.</i>
00 24 13.2	List of Alternates <i>The DP shall insert in this section a list and description of any additive or deductive alternates.</i>
00 25 00	Procurement Meetings
00 25 13	Pre-Bid Meeting A Mandatory Pre-Bid Meeting will be held at the Conference Room X , Facility Services , Building 77, Northern Arizona University, Flagstaff, Arizona, for benefit of all prospective Bidders on _____, 20_ at _:_.p.m. Facility Services, Planning, Design, and Construction Staff and DP will be present to discuss technical aspects of the project. All Bidders are required to be represented in order for their bid to be accepted by Owner.
00 25 13.1	Pre-Bid Site Inspection The pre-Bid Site inspection will be held immediately after the Pre-Bid Meeting. Each Bidder must be represented. No other formal inspection tours should be anticipated. Bidders should come prepared to gather all on-site information necessary for preparing proposal. A Bidder may arrange for supplemental site visits as necessary to prepare a responsive proposal. It is the responsibility of the Bidders to thoroughly familiarize themselves with all conditions and matters, which may in anyway affect the Work or cost thereof. No allowance shall be made on behalf of any contractor or subcontractor for errors due to his/her negligence in not being familiar with existing site and/or project conditions.
00 25 13.1.1	Supplementary Site Visits Arrangements for supplemental visits to the job site are to be made through: NAU Facility Services Planning, Design and Construction (928) 523-4227 Northern Arizona University Flagstaff, Arizona 86011
00 26 00	Substitution Procedures <u>For Competitive Sealed Bid Procurements (Hard Bid and Task Order Procurement):</u> If Bidder wishes to submit a product for consideration, refer to the Substitution Request Form (located in 00 43 25). Product Substitution Requests must be received 10 days before bid opening. Product Substitution Requests shall be submitted in accordance with 00 21 13.1. All other process of the below section will be followed.

Section
Number

Title

For Qualifications or Qualifications and Price Selections (CMAR, JOC, Design-Build Procurements):

To obtain approval to use unspecified products, Bidders can request substitutions of items felt to be equal to those listed in the specification and must be submitted, in writing for approval, utilizing the Substitution Request Form. If Owner/DP approves any such alternate product, notification shall be made to all prospective bidders a minimum of **three business days** prior to Bid. All such notifications shall be by Addendum.

Requests shall clearly describe the product for which approval is asked, including data necessary to demonstrate acceptability. The Owner and DP shall consider and either approve or reject proposals submitted. The Bidder’s request for approval shall include the following:

- a. Complete data substantiating compliance of the proposed substitution with the Contract Documents.
- b. Product identification, including manufacturer's name, address and phone number.
- c. Manufacturer's literature showing complete product description, performance and test data, and all reference standards.
- d. Samples and colors in the case of articles or products, as appropriate.
- e. Name and address of similar projects on which the product was used and date of installation.
- f. For construction methods, include a detailed description for proposed method and drawings illustrating same.
- g. Itemized comparison of proposed substitution with product or method specified.

Substitution requests shall be made on the Substitution Request Form included with the Bid Forms.

The decision of the Owner or DP regarding the approval of items for which substitution is requested will be final. In the event an approved substitution is later determined by the Owner or Design Professional to be unacceptable for any reason, including the necessity to perform extended redesign or rework of the project in order to accommodate the substitution, or if it becomes apparent to the Design Professional that the substituted item will not perform or function as well as the specified item, the Bidder will be required to furnish the original specified item or request approval to use another substitution. The Bidder will pay all costs, expenses or damages associated with or related to the unacceptability of a substitution and the resultant utilization of any item. The Bidder further understands and agrees that a time extension will not be granted due to delays associated with or related to the unacceptability of a substitution.

If a substitution is approved, no subsequent change in brand or make will be permitted unless satisfactory written evidence is presented to the Design Professional and approved by the Owner that the manufacturer cannot make scheduled delivery of the approved substitute item.

DIVISION 0 – PROCUREMENT AND CONTRACTING REQUIREMENTS

Section
Number Title

****END OF SECTION****

DIVISION 0 – PROCUREMENT AND CONTRACTING REQUIREMENTS

Section Number	Title
00 30 00	Available Information
00 31 00	Available Project Information
00 31 13	Preliminary Schedule
00 31 13.13	Preliminary Project Schedule
	First Advertisement: _____
	Second Advertisement: _____
	Pre-Bid Conferences: _____
	Bid Date: _____
	Construction Start: _____
	Substantial Completion: _____
	Final Completion: _____
00 31 13.16	Preliminary Construction Schedule
	<i>Information in this section to be included by the NAU PM when applicable</i>
00 31 19	Existing Condition Information
	<i>Information in this section to be included by the DP when applicable</i>
00 31 21	Survey Information
	<i>Information in this section to be included by the DP when applicable</i>
00 31 24	Environmental Assessment Information
	<i>Information in this section to be included by the DP when applicable</i>
00 31 25	Existing Material Information
	<i>Information in this section to be included by the DP when applicable</i>
00 31 26	Existing Hazardous Material Information

Section Title
Number

NORTHERN ARIZONA UNIVERSITY FORM FS-13: WORKPLACE HAZARD NOTIFICATION FOR CONTRACTORS AND SUBCONTRACTORS:

ASBESTOS/LEAD/PCBs RADIATION BIOLOGICAL CHEMICAL OTHER

PROJECT NAME: _____ NAU PROJECT#: _____

This form is used to provide Contractors and Subcontractors working at Northern Arizona University. NAU maintains comprehensive material/safety inspections and safety programs for campus buildings. Test results and safety programs are available for review in the NAU Office of Environmental Health & Safety (EH&S). The following known and assumed hazards have been identified to be present in the work area located in Building(s):

Room(s): _____

NAU is responsible for informing you of the presence of hazards in your project work area on the NAU campus. If you encounter any other previously unidentified hazards, stop all work immediately and contact the NAU Project Manager or EH&S. By law, Employers must provide training and/or protection for employees who will be working with or near hazards, including those covered by this notification. The responsible party signing below agrees that it is the Contractor's or Subcontractor's responsibility to be knowledgeable of and comply with all applicable local, state, federal laws and university policies related to the hazards detailed in this form.

Your signature below acknowledges that you have received notice from NAU that hazardous materials are or may be present in your work area(s), and that you agree to fully assume the responsibility for ensuring the safety of yourself and your employees, which includes ensuring that you comply with all applicable local, state, and federal laws, and university policies governing hazardous materials.

If you have questions, please contact NAU EH&S at 928-523-6435.

Company Name:	
Name of Responsible Party:	Title:
Signature:	Date:

Contractor shall complete, sign, and submit Form FS-13 to: Northern Arizona University
 Purchasing and Contract Services
 Box 4124
 Flagstaff, AZ 86011
 Telephone: 928-523-4557
 Fax: 928-523-1343

No work shall be authorized nor shall it commence prior to completion and return of Form FS-13 to the University at the address above by the contractor.

Approved EH&S Preparer _____ Date: _____

DIVISION 0 – PROCUREMENT AND CONTRACTING REQUIREMENTS

Section Number	Title
00 31 31	Geophysical Data <i>Information in this section to be included by the DP when applicable</i>
00 31 32	Geotechnical Data <i>Information in this section to be included by the DP when applicable</i>
00 31 43	NAU Permit Application The NAU permit application and procedure can be found at http://nau.edu/Facility-Services/DP_Contract/ .
00 31 46	Other Permits <i>Information in this section to be included by the DP when applicable</i>

****END OF SECTION****

Section Number	Title
00 40 00	PROCUREMENT FORM AND SUPPLEMENTS
00 41 00	Bid Forms
00 41 13	Bid Form

FORM OF BID (FS#1)
(INSERT PROJECT NAME)
NAU PROJECT NO. (INSERT PROJECT #)

The undersigned hereby proposed, and agrees to furnish all labor, material, transportation, supervision and services necessary to complete all work as called for in the plans and specifications, and that the lump sum bid includes all applicable costs of bonds, insurance, permits, and fees, and sales tax, or any applicable taxes. **The Owner’s selection will be made on a Bid (pre-tax) price per ABOR policy 3-803 A 7. The contract will be issued for the lump sum amount, inclusive of the tax.**

We acknowledge the following addenda and have included their provisions in this proposal.

Addendum No. _____ Dated _____
 Addendum No. _____ Dated _____
 Addendum No. _____ Dated _____
 Addendum No. _____ Dated _____

BASE BID: The undersigned proposes to complete all work as required per the Specifications, for a Lump Sum of:

Bid (pre-tax): _____ Dollars
 (\$ _____).
 Taxes: _____ Dollars
 (\$ _____).
 Cumulative Bid: _____ Dollars
 (\$ _____).

Additive Alternatives:

Alternate #1: (INSERT DESCRIPTION) The undersigned proposes to complete all work as required per the Specifications, for a Lump Sum of:

Bid (pre-tax): _____ Dollars
 (\$ _____).
 Taxes: _____ Dollars
 (\$ _____).
 Cumulative Bid: _____ Dollars
 (\$ _____).

Alternate #2: (INSERT DESCRIPTION) The undersigned proposes to complete all work as required per the Specifications, for a Lump Sum of:

Bid (pre-tax): _____ Dollars
 (\$ _____).
 Taxes: _____ Dollars
 (\$ _____).

DIVISION 0 – PROCUREMENT AND CONTRACTING REQUIREMENTS

Section Title
Number

Cumulative Bid: _____ Dollars
(\$_____).

All Additive Alternates are additive to the Base Bid. For each Additive Alternate, Bidders are instructed to provide only the incremental difference in cost of adding that particular work to the project scope of work. Do not provide cumulative costs that include values already included in the Base Bid as NAU will be evaluating bids and considering bid award based on the sum of the Base Bid and any combination of Additive Alternates.

Enclosed herewith is a cashier's check or Bid Bond (NAU form FS#9) made payable to the Owner in the amount of \$_____, which is not less than 10% of the amount of the total bid proposal, as a guarantee that the undersigned will furnish required Performance Bond and Labor and Material Bond, and enter into contract, on basis of above proposal.

Undersigned further agrees that said check (or Bid Bond) shall be forfeited as Liquidated Damages (no penalty) if undersigned fails to enter into contract after requested to do so by Owner.

Bids shown above are valid for a period of 60 days after the date of opening bids, and may be withdrawn following that date if no contract has been awarded.

The undersigned understands that the Owner reserves the right to reject any or all bids, or to waive any informality in receipt of the above Proposal. **Owner reserves the right to award by Base Bid alone, by the sum of Base Bid and any combination of Additive Alternate Amounts, or as the sum of the Base Bid and all the Additive Alternate Amounts, whichever is deemed most advantageous to Owner.**

It is hereby understood and mutually agreed by and between the Contractor and the Owner that the date of beginning, rate of progress, and time of completion of the Work as set forth in the contract documents are of the essence of the contract. The amount of \$_____ per calendar day will be assessed against the contract for work not completed at the Substantial Completion date. Said amounts shall accrue until such time that the Work covered under this contract is complete, not as a penalty, but as Liquidated Damages.

In addition, it is mutually agreed by and between the Contractor and the Owner, the amount of \$_____ per calendar day will be assessed against the contract for work not completed at the Final Completion date. Said amounts shall accrue until such time that the Work covered under this contract is complete, not as a penalty, but as Liquidated Damages.

The Proposer hereby certifies that he/she is the holder of a valid Contractor's License in accordance with Arizona State Law and that such license classification allows the Contractor to perform the type of construction identified by these Bid Documents. **The proposer also certifies that he/she holds all of the required certifications and licenses outlined in the bidding documents and shall provide proof of all certifications, licenses and warranties within 5 days of Owner notification to the apparent low bidder with the Intent to Award.**

DIVISION 0 – PROCUREMENT AND CONTRACTING REQUIREMENTS

Section Number Title

If corporation,

Seal

Company/Corporation

Signature

Date

Signature

Arizona License Class and Number

Section Number	Title
00 43 00	Procurement Form Supplements
00 43 13	Bid Security Form



BID BOND (FS#9)

KNOW ALL MEN BY THESE PRESENTS, that we _____
 (Here insert full name and address or legal title of Contractor)
 as Principal, hereinafter called the Principal, and _____
 (Here insert full name and address or legal title of Surety)
 a corporation duly organized under the laws of the State of _____
 as Surety, hereinafter called the Surety, are held and firmly bound unto _____
 (Here insert full name and address or legal title of Owner)
 as Obligee, hereinafter called the Obligee, in the sum of Dollars (\$ _____), for the payment of
 which sum well and truly to be made, the said Principal and the said Surety, bind ourselves, our heirs,
 executors, administrators, successors and assigns, jointly and severally, firmly by these presents.
 WHEREAS, the Principal has submitted a bid for _____
 (Here insert full name, address and description of project)

NOW, THEREFORE, if the obligee shall accept the bid of the Principal and the Principal shall enter into a
 Contract with the Obligee in accordance with the terms of such bid, and give such bond or bonds as may
 be specified in the bidding or Contract Documents with good and sufficient surety for the faithful
 performance of such Contract and for the prompt payment of labor and material furnished in the
 prosecution thereof, or in the event of the failure of the Principal to enter such Contractor and give such
 bond or bonds, it the Principal shall pay to the Obligee the difference not to exceed the penalty hereof
 between the amount specified in said bid and such larger amount for which the Obligee may in good
 faith contract with another party to perform the Work covered by said bid, then this obligation shall be
 null. and void, otherwise to remain in full force and effect.

Signed and sealed this _____ day of _____, 20__.

(Witness)

(Principal) (Seal)

(Title)

(Surety company) (Seal)

(Witness)

DIVISION 0 – PROCUREMENT AND CONTRACTING REQUIREMENTS

Section
Number Title

Section Title
Number

00 43 25 Substitution Request Form

MATERIAL/EQUIPMENT SUBSTITUTION REQUEST FORM

TO: _____

PROJECT: _____

We hereby submit for your consideration the following product instead of the specified item for the above project:

<u>Section</u>	<u>Page</u>	<u>Paragraph/Line</u>	<u>Specified Item</u>
----------------	-------------	-----------------------	-----------------------

Proposed Substitution: **Product Identification – include manufacturer’s name, address, and phone number**

Attach complete product descriptions, drawings, photographs, performance and test data, manufacturer literature, samples and colors in the case of articles or products, and other information necessary for evaluation.

Similar projects on which the product was used (include Project, Owner, Owner’s Contact information, Location, and date):

1. _____
2. _____
3. _____

A. Will changes be required to building design in order to properly install proposed substitution? Yes ___ No ___ . If Yes, explain: _____

B. Will the undersigned pay for changes to the building design, including engineering and drawing costs, caused by requested substitution? Yes ___ No ___.

C. What differences exist between proposed substitution and specified item?

D. Does substitution affect Drawing dimensions: Yes ___ No ___ . If yes, explain. _____

E. What affect does substitution have on other trades? _____

DIVISION 0 – PROCUREMENT AND CONTRACTING REQUIREMENTS

Section Title
Number

F. Does Manufacturer's warranty of proposed substitution differ from that specified?
Yes ___ No ___ If yes, explain. _____

G. Will substitution effect progress schedule? Yes ___ No ___. If yes, explain:

H. Will substitution require more license fees or royalties than specified product?
Yes ___ No ___. If Yes, explain _____

I. Will substitution differ in cost from the specified product? Yes ___ No ___
If yes, explain how much _____

J. Will maintenance and service parts be locally available for substitution?
Yes ___ No ___. If no, explain _____

K. What is the code impact of this substitution request? Specify the section(s) of the applicable code(s) this impacts.

Submitted By: _____
Signature _____
Firm _____
Address _____
Date _____
Telephone _____

For DP's Use Only:
____ Accepted ____ Accepted as Noted
____ Not Accepted
Remarks: _____
DP Signature: _____
Date: _____

For Owner's Use Only:
____ Accepted ____ Accepted as Noted
____ Not Accepted
Remarks: _____
Owner Signature: _____
Date: _____

Section Title
 Number
 00 43 36 Proposed Subcontractors Form

SUBCONTRACTOR LIST FS #3

PROJECT NAME: _____

PROJECT NO.: _____

Proposer is to list **every** subcontractor and supplier proposed to be employed on the above project as required by the bidding documents. **All Sections of the specifications must be included below.** Any work proposed to be done by the Bidder should be listed as a line item with the word "Self" inserted under firm name. Designation of subcontractors is subject to University approval. No change in subcontractor's list will be permitted without the University's prior written consent. **Failure to provide a complete list with all information may be considered non-responsive. Subcontractor List must be enclosed inside bid package per Section 00 43 36. All bidders must sign page 2 of this subcontractor list, even if all work will be self-performed.**

 [WORK] [LICENSE #] [CLASS] [CONTACT PERSON]

 [FIRM NAME] [ADDRESS] [CITY/STATE/ZIP] [PHONE]

 [WORK] [LICENSE #] [CLASS] [CONTACT PERSON]

 [FIRM NAME] [ADDRESS] [CITY/STATE/ZIP] [PHONE]

 [WORK] [LICENSE #] [CLASS] [CONTACT PERSON]

 [FIRM NAME] [ADDRESS] [CITY/STATE/ZIP] [PHONE]

 [WORK] [LICENSE #] [CLASS] [CONTACT PERSON]

 [FIRM NAME] [ADDRESS] [CITY/STATE/ZIP] [PHONE]

DIVISION 0 – PROCUREMENT AND CONTRACTING REQUIREMENTS

Section Title
Number

[WORK] [LICENSE #] [CLASS] [CONTACT PERSON]

[FIRM NAME] [ADDRESS] [CITY/STATE/ZIP] [PHONE]

[WORK] [LICENSE #] [CLASS] [CONTACT PERSON]

[FIRM NAME] [ADDRESS] [CITY/STATE/ZIP] [PHONE]

[WORK] [LICENSE #] [CLASS] [CONTACT PERSON]

[FIRM NAME] [ADDRESS] [CITY/STATE/ZIP] [PHONE]

[WORK] [LICENSE #] [CLASS] [CONTACT PERSON]

[FIRM NAME] [ADDRESS] [CITY/STATE/ZIP] [PHONE]

[WORK] [LICENSE #] [CLASS] [CONTACT PERSON]

[FIRM NAME] [ADDRESS] [CITY/STATE/ZIP] [PHONE]

[WORK] [LICENSE #] [CLASS] [CONTACT PERSON]

[FIRM NAME] [ADDRESS] [CITY/STATE/ZIP] [PHONE]

[WORK] [LICENSE #] [CLASS] [CONTACT PERSON]

[FIRM NAME] [ADDRESS] [CITY/STATE/ZIP] [PHONE]

I submit that the preceding is correct and current as of _____
[BID OPENING DATE]

[COMPANY] [AUTHORIZED REPRESENTATIVE] [DATE]

DIVISION 0 – PROCUREMENT AND CONTRACTING REQUIREMENTS

Section Number	Title
00 43 83	Proposed Construction Schedule Form

DIVISION 0 – PROCUREMENT AND CONTRACTING REQUIREMENTS

Section Title
Number

2. _____
[NAME] [ADDRESS] [PHONE NO.]

3. _____
[NAME] [ADDRESS] [PHONE NO.]

MY MY NOTARIZED SIGNATURE BELOW I HEREBY SWEAR THAT THE ANSWERS TO THE FOREGOING QUESTIONS AND ALL STATEMENTS HERE CONTAINED AND ATTACHED ARE TRUE AND CORRECT.

[CONTRACTOR NAME OR AGENT] [DATE]

SUBSCRIBED AND SWORN BEFORE ME THIS _____ DAY OF _____, 20____.

NOTARY PUBLIC: _____

MY COMMISSION EXPIRES: _____

- 00 50 00 Contracting Forms and Supplements
- 00 52 00 Agreement Forms
- 00 52 13 Agreement Form

DIVISION 0 – PROCUREMENT AND CONTRACTING REQUIREMENTS

Section
Number

Title

The form of agreement between the Owner and Contractor shall be the Construction Agreement Between Owner and Contractor, Arizona Board of Regents. A copy of the latest version is available for review at on the website for information purposes only.

The aforementioned forms are hereby made a part of this Document and shall be binding to the same extent as if they were written in full herein.

****END OF SECTION****

00 60 00
00 61 00
00 61 13

Project Forms
Bond Forms
Performance and Payment Bond Forms

Project xx.xxx.xxx – Project Name

DIVISION 0 – PROCUREMENT AND CONTRACTING REQUIREMENTS

Section
Number Title

ARIZONA BOARD OF REGENTS **PERFORMANCE BOND FS#4**
PURSUANT TO BOARD OF REGENTS POLICY 3-804E
(Penalty of this bond must be 100% of the Contract Amount)

DIVISION 0 – PROCUREMENT AND CONTRACTING REQUIREMENTS

Section Title
Number

KNOW ALL MEN BY THESE PRESENTS:

That, _____
(hereinafter called the Principal), as Principal, and _____
a corporation organized and existing under the laws of the State of _____, with its
principal office in the City of _____ (hereinafter called the Surety), as Surety, are held
and firmly bound unto the Arizona Board of Regents, (hereinafter called the Obligee), in the amount of .
_____ Dollars (\$ _____), for the payment whereof, the said Principal and Surety
bind themselves, and their heirs, administrators, executors, successors and assigns, jointly and severally,
firmly by these presents.

WHEREAS, the Principal has entered into a certain written contract with the Obligee, dated the ____
__ day of _____, 20____, to construct and complete a certain work described as _____
_____ which contract is hereby referred to and made a part
hereof as fully and to the same extent as if copied at length herein.

NOW, THEREFORE, THE CONDITION OF THIS OBLIGATION IS SUCH, that if the said Principal shall
faithfully perform and fulfill all the undertakings, covenants, terms, conditions and agreements of said
contract during the original term of said contract and any extension thereof, with or without notice to the
Surety and during the life of any guaranty required under the contract, and shall also perform and fulfill all
the undertakings, covenants, terms, conditions, and agreements of any and all duly authorized
modifications of said contract that may hereafter be made, notice of which modifications to the Surety
being hereby waived; then the above obligation shall be void, otherwise to remain in full force and effect.

PROVIDED, HOWEVER, that this bond is executed pursuant to the provisions of Board of Regents
Policy Section 3-804E, and all liabilities on this bond shall be determined in accordance with the
provisions of the section, to the same extent as if copied at length herein.

The prevailing party in a suit on this bond, including any appeal thereof, shall recover as a part of his
judgment such reasonable attorneys' fees as may be fixed by a judge of the Court.

Witness our hands this _____ day of _____, 20____.

PRINCIPAL SEAL

SURETY SEAL

By: _____

BY: _____

Bond Number

Agent Name & Telephone

Bonding Company & Telephone

Agent Address

Bonding Company Address

DIVISION 0 – PROCUREMENT AND CONTRACTING REQUIREMENTS

Section Title
Number

Arizona Board of Regents PAYMENT BOND FS#5
PURSUANT TO BOARD OF REGENTS POLICY 3-804E
(Penalty of this bond must be 100% of the Contract Amount)

KNOW ALL MEN BY THESE PRESENTS:

That, _____
(hereinafter called the Principal), as Principal, and _____
a corporation organized and existing under the laws of the State of _____,
with its principal office in the City of _____ (hereinafter called the Surety), as Surety,
are held and firmly bound unto the Arizona Board of Regents, (hereinafter called the Obligee), in the
amount of _____ Dollars (\$ _____), for the payment whereof,
the said Principal and Surety bind themselves, and their heirs, administrators, executors, successors and
assigns, jointly and severally, firmly by these presents.

WHEREAS, the Principal has entered into a certain written contract with the Obligee, dated the _____
_____ day of _____, 20____, to construct and complete a certain work
described as _____ which contract is hereby
referred to and made a part hereof as fully and to the same extent as if copied at length herein.

NOW, THEREFORE, THE CONDITION OF THIS OBLIGATION IS SUCH, that if the said Principal shall
promptly pay all monies due to all persons supplying labor or materials to him/her or his/her
subcontractors in the prosecution of the work provided for in said contract, then this obligation shall be
void, otherwise to remain in full force and effect.

PROVIDED, HOWEVER, that this bond is executed pursuant to the provisions of Board of Regents
Policy Section 3-804E, and all liabilities on this bond shall be determined in accordance with the
provisions of the section, to the same extent as if copied at length herein.

The prevailing party in a suit on this bond, including any appeal thereof, shall recover as a part of his
judgment such reasonable attorneys' fees as may be fixed by a judge of the Court.

Witness our hands this _____ day of _____, 20____.

PRINCIPAL SEAL

SURETY SEAL

BY: _____

BY: _____

Bond Number

Agent Name & Telephone

Bonding Company & Telephone

Agent Address

Bonding Company Address

DIVISION 0 – PROCUREMENT AND CONTRACTING REQUIREMENTS

Section Title
Number
00 62 00 Certificates and Other Forms

00 62 11 Submittal Transmittal Form (FS#27)

CONTRACTORS SUBMITTAL TRANSMITTAL FORM

PROJECT #:	CONTRACTOR:
PROJECT NAME:	DATE:
TO (OWNER): Northern Arizona University Facility Services Planning, Design, & Construction PO Box 5637 Flagstaff, AZ 86011	SUBMITTAL NO: <input type="checkbox"/> New Submittal <input type="checkbox"/> Resubmittal

Specification Section No.: _____

Schedule Date of Submittal: _____

Submittal Type: Shop Drawing Sample Other: _____

THE FOLLOWING ITEMS ARE HEREBY SUBMITTED:

Number of Copies	Description of Item Submitted (Type, Size, Model Number, Etc.)	Spec and Para. No.	Drawing or Brochure Number	Contains Variation to Contract	
				Yes	No

CONTRACTOR hereby certifies that (i) CONTRACTOR has complied with the requirements of Contract Documents in preparation, review, and submission of designated Submittal and (ii) the Submittal is complete and in accordance with the Contract Documents and requirements of laws and regulations and governing agencies.

CONTRACTOR SIGNATURE PRINT DATE

Arizona Board of Regents

OWNER SIGNATURE PRINT DATE

DIVISION 0 – PROCUREMENT AND CONTRACTING REQUIREMENTS

Section Title
 Number
 00 62 16 Certificate of Insurance Form (FS#6)

**ARIZONA BOARD OF REGENTS
 CERTIFICATE OF INSURANCE (FS#6)**

PROJECT NAME:

NAU PROJECT #:

PRODUCER	COMPANIES AFFORDING COVERAGE Insurance is to be placed with duly licensed or approved non-admitted insurers in the State of Arizona with an A.M. Best rating of not less than A- VII	CURRENT A.M. BEST RATING
	A	
	B	
INSURED	C	

Contractor shall furnish Northern Arizona University with certificates of insurance (ACORD form or equivalent approved by the State of Arizona). The certificates for each insurance policy are to be signed by a person authorized by that insurer to bind coverage on its behalf. All certificates of endorsements are to be received and approved by Northern Arizona University before work commences. Each insurance policy required by this Contract must be in effect at or prior to commencement of work under this Contract and remain in effect for the duration of the project. Failure to maintain the insurance policies as required by this Contract, or to provide evidence of renewal, is a material breach of contract.

CO LTR	TYPE OF INSURANCE	POLICY NUMBER	POLICY EFFECTIVE DATE (MM/DD/YY)	POLICY EXPIRATION DATE (MM/DD/YY)	LIMITS	
	<u>GENERAL LIABILITY</u> COMMERCIAL GENERAL LIABILITY : OCCURRENCE				GENERAL AGGREGATE	\$ 2,000,000
					PRODUCTS-COMP/OP AGG.	\$ 1,000,000
					PERSONAL & ADV INJURY	\$ 1,000,000
					EACH OCCURRENCE	\$ 1,000,000
					FIRE DAMAGE (Any one fire)	\$ 50,000
	<u>AUTOMOBILE LIABILITY</u> : ANY AUTO				COMBINED SINGLE LIMIT	\$ 1,000,000
	<u>PROFESSIONAL LIABILITY</u> <input type="checkbox"/> TYPE: _____ <input type="checkbox"/> CLAIMS MADE <input type="checkbox"/> OCCURRENCE				EACH OCCURRENCE	\$ 1,000,000
	<u>EXCESS LIABILITY</u> <input type="checkbox"/> UMBRELLA FORM <input type="checkbox"/> OTHER THAN UMBRELLA FORM				AGGREGATE	
	<u>WORKERS COMPENSATION AND EMPLOYERS' LIABILITY</u>				EACH OCCURRENCE	\$
	<u>BUILDERS RISK</u>				AGGREGATE	
					STATUTORY LIMITS	
					EACH ACCIDENT	\$ 1,000,000
					DISEASE-POLICY LIMIT	\$ 1,000,000
					DISEASE-EA EMPLOYEE	\$ 1,000,000
					FACE AMOUNT OF CONTRACT	\$

THIS CERTIFICATE APPLIES TO ANY AND ALL PROJECTS AT NORTHERN ARIZONA UNIVERSITY. DESCRIPTION OF OPERATIONS/LOCATIONS/VEHICLES/SPECIAL ITEMS:

>THE POLICIES FOR GENERAL LIABILITY AND AUTOMOBILE LIABILITY SHALL BE ENDORSED TO INCLUDE THE FOLLOWING ADDITIONAL INSURED LANGUAGE: "THE STATE OF ARIZONA, ITS DEPARTMENTS, AGENCIES, BOARDS, COMMISSIONS, UNIVERSITIES AND ITS OFFICERS, OFFICIALS, AGENTS, AND EMPLOYEES SHALL BE NAMED AS ADDITIONAL INSURED WITH RESPECT TO LIABILITY ARISING OUT OF THE ACTIVITIES PERFORMED BY OR ON BEHALF OF THE CONTRACTOR.
 >IT IS AGREED THAT COVERAGES AFFORDED UNDER THE POLICIES CERTIFIED IN THIS CERTIFICATE SHALL BE PRIMARY FOR THE PERSON OR ORGANIZATION SHOWN IN THE SCHEDULE, BUT ONLY WITH RESPECT TO LIABILITY ARISING OUT OF YOUR WORK FOR THAT INSURED BY OR FOR YOU. OTHER INSURANCE AFFORDED TO THAT INSURED WILL APPLY AS EXCESS AND NOT CONTRIBUTE AS PRIMARY TO THE INSURANCE AFFORDED BY THIS ENDORSEMENT.
 >IT IS FURTHER AGREED THAT SHOULD ANY OF THE ABOVE DESCRIBED POLICIES BE CANCELLED BEFORE THE EXPIRATION DATE THEREOF, THE ISSUING INSURER WILL ENDEAVOR TO MAIL 30 DAYS WRITTEN NOTICE TO THE CERTIFICATE HOLDER. THIS CERTIFICATE IS NOT VALID UNLESS COUNTERSIGNED BY AN AUTHORIZED REPRESENTATIVE OF THE INSURANCE COMPANY.
 >POLICIES FOR GENERAL LIABILITY, AUTO LIABILITY, AND WORKERS' COMPENSATION SHALL CONTAIN A WAIVER OF SUBROGATION AGAINST THE STATE OF ARIZONA, ITS DEPARTMENTS, AGENCIES, BOARDS, COMMISSIONS, UNIVERSITIES & ITS OFFICERS, OFFICIALS, AGENTS, & EMPLOYEES FOR LOSSES ARISING FROM WORK PERFORMED BY OR ON BEHALF OF THE CONTRACTOR.

CERTIFICATE HOLDER/ADDITIONAL INSURED NORTHERN ARIZONA UNIVERSITY THE ARIZONA BOARD OF REGENTS THE STATE OF ARIZONA FACILITY SERVICES BOX 5637 FLAGSTAFF, AZ 86011	AUTHORIZED REPRESENTATIVE OF THE INSURANCE COMPANY
	SIGNATURE DATE

DIVISION 0 – PROCUREMENT AND CONTRACTING REQUIREMENTS

Section Number	Title
00 62 23	<p>Construction Waste Diversion Form</p> <p>Owner participates annually in the best international sustainability assessment conducted by the Association for the Advancement of Sustainability in Higher Education (AASHE). Owner has been participating in AASHE’s Sustainability Tracking, Assessment, and Rating System (STARS) since 2011 and currently maintains a Gold Ranking. Participation in this program continuously gets NAU great rating’s in Sierra Club’s “Cool Schools” issue the Princeton Review’s “Greenest Schools” issue. This report collects information on, “Construction and Demolition Waste Diversion” which requires detailed tracking of all construction waste on campus. Contractors are required to track waste on certain projects. Confirm with Owner at the beginning of each project on whether or not it is needed. The FS 49 Construction Waste Tracking Log is located online at: http://nau.edu/Facility-Services/Planning/Forms-Index/</p>
00 62 34	Recycled Content of Materials Form
00 62 76	<p>Application for Payment Form</p> <p>All payments shall be made in accordance with the Agreement, and utilize the FS #11 for Contractors, the FS #60 for Design Builders, and the FS #98 for Design Professionals.</p>
00 63 00	<p>Clarification and Modification Forms</p> <p>Many of the NAU forms are located at: http://nau.edu/Facility-Services/Planning/Forms-Index/</p>
00 63 13	Request for Interpretation Form
00 63 19	Clarification Form
00 63 25	<p>Substitution Request Form (During Construction)</p> <p>Any substitutions to the specifications must be approved by Owner and DP using the Substitution Request Form in Section 00 43 25.</p>
00 63 33	Supplemental Instruction Form
00 63 36	Field Order Form
00 63 43	Written Amendment Form
00 63 46	<p>Construction Change Directive Form</p> <p>This form can be located on the NAU Facility Services website.</p>
00 63 57	<p>Construction Change Proposal Request</p> <p>This form can be located on the NAU Facility Services website, as FS #12.</p>
00 63 63	Change Order Form
00 63 66	<p>Contingency Use Authorization Form</p> <p>This form can be located on the NAU Facility Services website.</p>
00 63 69	<p>Allowance Use Authorization Form</p> <p>This form can be located on the NAU Facility Services website.</p>

Section
Number

00 65 00

Title

Closeout Forms

Closeout Forms and Other Project Closeout Requirements - may include but are not limited to the following:

A. Substantial Completion

1. Fire Marshal Acceptance Alarm/Sprinkler and State Fire Marshal Acceptance Report
2. State Elevator Inspection Report
3. Insurance Carrier Certificate for Boiler Inspection
4. Preliminary Balance Report
5. Preliminary As-Builts
6. Attic Stock
7. Substantial Completion Project Inspection (FS #15)
8. Punchlist Issued (FS#24)
9. Certificate of Substantial Completion (FS#81)
10. Schedule of Required Maintenance (FS#88)

B. Final Completion

1. Final Balance Report
2. Final As-Builts
3. First Season Commissioning Complete
4. Second Season Commissioning Complete
5. Operations and Maintenance Manuals
6. Electronic Copy of All Approved Submittals and Shop Drawings
7. Special Warranties
8. Keys Returned (FS#10)
9. Project Final Inspection (FS#15)
10. Punchlist Complete (FS#24)
11. Project Warranty (FS#80)
12. Certificate of Final Completion (FS#81A)
13. Affidavit Non Use Asbestos Certificate (FS#83)

C. Final Payment

1. Contractor Final Payment Application
2. Final Subcontractor List (FS#82)
3. All Subcontractor Lien Releases (FS#84)
4. Consent of Surety to Final Payment Received (FS#88)
5. General Contractor Lien Release (FS#89)
6. Contractor Affidavit of Payment (FS#99)

Templates of the forms (FS#) can be found at: <http://nau.edu/Facility-Services/Planning/Forms-Index/>

- 00 65 14 Punchlist Form (FS#24)
- 00 65 15 Project Inspection Form (FS#15)
- 00 65 16 Certificate of Substantial Completion Form (FS#81)

DIVISION 0 – PROCUREMENT AND CONTRACTING REQUIREMENTS

Section Number	Title
00 65 17	Schedule of Required Maintenance Form (FS#88)
00 65 19	Certificate of Final Completion Form (FS#81A)
00 65 19.13	Affidavit of Payment (FS#99)
00 65 19.16	General Contractor Lien Release Form (FS#89)
00 65 19.17	Subcontractor Lien Release Form (FS #84)
00 65 19.19	Consent of Surety to Final Payment Form (FS#87)
00 65 19.19	Final Subcontractor List (FS#82)
00 65 36	Warranty Form (FS#80)

****END OF SECTION****

Section Number	Title
00 70 00	Conditions of the Contract
00 71 00	Contracting Definitions
00 72 00	<p>General Conditions</p> <p>The General Conditions of the Standard Form Agreement Between Owner and Contractor, Arizona Board of Regents are hereby made part of the Contract Documents, as if they are included in the following pages. A copy is appended to the construction agreement and available for review at http://nau.edu/Facility-Services/DP_Contract/ or information purposes only.</p> <p>The General Conditions are a part of the Contract and shall be binding on the General Contractor and all Subcontractors as if bound into this document.</p>
00 73 00	Supplementary Conditions
00 73 15	<p>Bonds and Certificates</p> <p>The Bid price shall include the cost of Payment and Performance Bonds. Bonds shall cover the faithful performance, labor and material (100%) of the Contract and payment of all obligations (100%) arising thereunder in the form prescribed in Arizona Board of Regents Policy 3-804E. Bonds shall be executed by Corporate Sureties licensed in Arizona. Bonds must be submitted on the forms included in Section 00 61 13.</p> <p>Performance Bond</p> <p>Pursuant to Arizona Board of Regents Policy, the Contractor shall file with the Owner, prior to the time of execution of the Contract, a Performance Bond on the Owner approved Form, referenced in, Section 00 61 13.13 in a penal sum equal to one hundred percent (100%) of the Contract. The Performance Bond must be executed on the above noted form. Substitutions will not be allowed. The Surety furnishing this bond shall be satisfactory to the Owner and shall be authorized to do business in the State of Arizona.</p> <p>Payment Bond</p> <p>Pursuant to Arizona Board of Regents Policy, the Contractor shall file with the Owner prior to the time of execution of the Contract, a Payment Bond on the Owner approved Form, referenced in Section 00 62 13, in a penal sum equal to one hundred percent (100%) of the Contract. The Payment Bond must be executed on the above noted form. Substitutions will not be allowed. The Surety furnishing this bond shall be satisfactory to the Owner and shall be authorized to do business in the State of Arizona.</p> <p>Certificates of Compliance with Applicable Laws and Regulations</p> <p>Lien Releases</p> <p>Upon completion of this Project, and before final payment is made, the Contractor will furnish to the Owner one hundred percent (100%) Unconditional Lien Releases from all subcontractors, material dealers and other participants doing work under this Contract.</p>

DIVISION 0 – PROCUREMENT AND CONTRACTING REQUIREMENTS

Section Number	Title
	If payment to Subcontractors is outstanding pending final payment by the University to Contractor, or if for any other reason 100% Unconditional Lien Releases cannot be obtained from all subcontractors, the Contractor may provide the University with an indemnity bond.
00 73 16	Insurance Requirements Insurance Requirements are defined by the contract.
00 73 19	Health and Safety Requirements Beginning July 1, 2016, the use of all tobacco products, including those not approved by the FDA for cessation is prohibited on university property, facilities, grounds, parking structures, privately-owned vehicles and structures owned or leased by the University. This includes, but is not limited to, the use of cigarettes, e-cigarettes, hookah, e-hookah, chew, dip, snuff, cigars, pipes, vaporizers, etc.
00 73 34	Affirmative Action for Disabled Workers Refer to http://nau.edu/Facility-Services/DP_Contract/ for specific requirements within the Construction Agreement.
00 73 36	Equal Employment Opportunity Requirements Northern Arizona University is an equal opportunity employer and all contracts with the University are subject to the conditions and requirements of Executive Order No. 99-4 as stated below.

EXECUTIVE ORDER No. 99-4

PROHIBITION OF DISCRIMINATION IN STATE CONTRACTS, NON-DISCRIMINATION IN EMPLOYMENT BY GOVERNMENT CONTRACTORS AND SUBCONTRACTORS

PART I:

Non-discrimination in employment by government contractors and subcontractors.

All government contracting agencies shall include in every government contract hereinafter entered into the following provisions:

A. The contractor will not discriminate against any employee or applicant for employment because of race, age, color, religion, sex or national origin. The contractor will take affirmative action to insure that applicants are employed and that employees are treated during employment without regard to their race, age, color, religion, sex or national origin. Such action shall include but not be limited to the following: Employment, upgrading, demotion or transfer, recruitment or recruitment advertising, lay-off or termination, rates of pay or other forms of compensation, and selection for training, including apprenticeship. The contractor agrees to post in conspicuous places available to employees and applicants for employment notices to be provided by the contracting officer setting forth the provisions of this nondiscrimination clause.

Section
Number

Title

B. The contractor will in all solicitations or advertisement for employees placed by or on behalf of the contractor state that all qualified applicants will receive consideration for employment without regard to race, age, color, religion, sex or national origin.

C. The contractor will send to each labor union or representative of workers with which he has a collective bargaining agreement or other contract or understanding a notice to be provided by the agency contracting officer advising the labor union or workers' representative of the contractor's commitments under this Executive Order and shall post copies of the notice in conspicuous places available to employees and applicants for employment.

D. The contractor will furnish all information and reports required by the contracting agency and will permit access to his books, records and accounts by the contracting agency and the Civil Rights Division for purposes of investigation to ascertain compliance with such rules, regulations and orders.

E. In the event of the contractor's noncompliance with the nondiscrimination clauses of this contract or with any of such rules, regulations or order of the Arizona Civil Rights Division said noncompliance will be considered a material breach of the contract and this contract may be canceled, terminated or suspended in whole or in part, and the contractor may be declared ineligible for further government contracts until said contractor has been found to be in compliance with the provisions of this order and the rules and regulations of the Arizona Civil Rights Divisions, and such sanctions may be imposed and remedies revoked as provided in Part II of this order, and the rules and regulations of the Arizona Civil Right Division.

F. The contractor will include the provisions of paragraphs A through E in every subcontractor purchase order so that such provisions will be binding upon each subcontractor or vendor. The contractor will take such action with respect in the subcontract or purchase order as the contracting agency may direct as a means of enforcing such provisions, including sanctions for noncompliance; provided, however, that in the event the contractor becomes involved in or is threatened with litigation with a subcontractor or vendor as a result of such direction by the contracting agency, the contractor may request the State of Arizona to enter into such litigation to protect the interests of the State of Arizona.

G. Each contractor having a contract containing the provisions prescribed in this section shall file and shall cause each of his subcontractors to file compliance reports with the contracting agency or the Civil Rights Division, as may be directed. Compliance reports shall be filed within such ties and shall contain such information as the practices, policies, programs and employment policies, programs and employment statistics of the contractor and each subcontractor and shall be in such form as the Arizona Civil Rights Division may prescribe.

H. Bidders or prospective contractors or subcontractors shall be required to state whether they have participated in any previous contract subject to the provisions of this order or any preceding similar Executive Order and in that event to submit on behalf of themselves and the

Section
Number

Title

proposed subcontractors compliance reports prior to, or as an initial part of negotiation of a contract.

I. Whenever the contractor or subcontractor has a collective bargaining agreement or other contract or understanding with a labor union or an agency referring workers or providing or supervising apprenticeship or training for such workers, the compliance report shall include such information from such labor unions or agency practices and policies affecting compliance as the contracting agency or Civil Rights Division may prescribe; provided that, to the extent such information is within the exclusive possession of a labor union or an agency referring workers or providing supervision apprenticeship or training and such labor union or agency shall refuse to furnish such information to the contractor, the contractor shall so certify the contracting agency as part of its compliance report and shall set forth what efforts he has made to obtain such information.

J. The contracting agency or the Civil Rights Division shall require that the bidder or prospective contractor or subcontractor shall submit as part of his compliance report a statement in writing signed by an authorized officer or agent on behalf of any labor union or any agency referring works or providing or supervising apprenticeship or other training with which the bidder or prospective contractor deals with supporting information to the effect that the signer's practices and policies do not discriminate on the ground of race, color, religion, sex or national origin, and that the signer either will affirmatively cooperate in the implementation of the policy and provisions of this order or that it consents and agrees that recruitment employment and the terms and conditions of employment under the proposed contract shall be in accordance with the purpose and provisions of this order. In the event that the union or the agency shall refuse to execute such a statement, the compliance shall so certify and set forth what efforts have been made to secure such a statement and such additional factual material as the contracting agency or the Civil Rights Division may require.

PART II.

Enforcement

The parties to the contract agree that the Civil Rights Division may investigate the employment practices of the contractor or any subcontractor employed by the contractor or initiate an investigation by an appropriate contracting agency or determine whether or not any of the contractual provisions pertaining to discrimination in this contract have been violated. Such investigations shall be conducted in accordance with the procedures established by the Civil Rights Division, and the investigation agency shall report to the Civil Rights Division any action taken or recommended. The Civil Rights Division may receive and investigate or cause to be investigated complaints by employees or prospective employees of the contractor or subcontractor under this agreement which allege discrimination contrary to the contractual provisions of this agreement. If the investigation is conducted for the Civil Rights Division by an agency other than the Civil Rights Division, that agency shall report to the Civil Rights Division what action has been taken or is recommended with regard to such complaint.

DIVISION 0 – PROCUREMENT AND CONTRACTING REQUIREMENTS

Section
Number

Title

00 73 37

Legal Worker Requirements

Refer to http://nau.edu/Facility-Services/DP_Contract/ for specific requirements within the Construction Agreement.

DIVISION 0 – PROCUREMENT AND CONTRACTING REQUIREMENTS

Section
Number

00 73 38

Title

Sudan, Iran & Israel
Refer to http://nau.edu/Facility-Services/DP_Contract/ for specific requirements within the Construction Agreement.

Legislation has been enacted to prohibit the University from contracting with firms currently engaged in a Boycott of Israel. To ensure compliance with A.R.S. §35-393 and §35-393.01 this form to be completed and returned to Owner.

By signing this form, Bidder certifies that it is not currently engaged in and agrees, for the duration of the Contract, to not engage in a Boycott of Israel.

Name of Bidder		
Name of Contact		Title of Contact
Address 1		Address 2
City	State	Zip Code
		-
Telephone Number		E-mail address, if available
() -		() -
Print Name of Offeror’s Authorized Agent		Signature of Offeror’s Authorized Agent
Title of Offeror’s Authorized Agent		Date

DIVISION 0 – PROCUREMENT AND CONTRACTING REQUIREMENTS

Section Number	Title
00 73 39	<p>Minority Business Enterprise Requirements Refer to http://nau.edu/Facility-Services/DP_Contract/ for specific requirements within the Construction Agreement.</p>
00 73 50	<p>Liquidated Damages</p> <p>It is hereby understood and mutually agreed, by and between Contractor and Owner, that the date of beginning, rate of progress and the time for completion of the work to be done hereunder are essential conditions of this Contract; and it is further mutually understood and agreed that the work embraced in this Contract shall be commenced on the date to be specified in the Notice to Proceed, Notice of Award, Contract and/or Agreement.</p> <p>The Contractor agrees that said work shall be prosecuted regularly, diligently and uninterruptedly at such rate of time he specifies. It is expressly understood and agreed, by and between the Contractor and Owner, that the time for completion of the work will be set by the Substantial and Final completion dates as identified in Notice to Proceed, Notice of Award, Contract and/or Agreement..</p> <p>Now, if the said Contractor shall neglect, fail, or refuse to complete the Work by the specified date, then the Contractor does hereby agree, as a part consideration for the awarding of the Contract, to pay the Owner a certain sum, as outlined hereafter, per calendar day, until the Project is completed, not as a penalty, but as Liquidated Damages for each breach of contract as hereinafter set forth, for each and every calendar day that the Contractor shall be in default after the time stipulated in the Contract for completing the work.</p> <p>For each calendar day that any part of the work remains uncompleted after the expiration of the time specified and/or allowed for completion of the work stipulated in the contract or approved increase by the additional work or materials ordered after the contract is signed, effecting the critical path schedule of the project, the sum per day shall be deducted from any monies due the Contractor, or if no money is due the Contractor, the Owner shall have the right to recover said sum or sums from the Contractor, from the surety or from both.</p> <p>It shall be understood that the time to complete the Project, beyond the contractual date of completion is in itself prima facie evidence of actual damages incurred, and the amount of these deductions are to cover the Liquidated Damages caused by the loss of use, or limited use, of the building and other additional Owner incurred losses, or expenses, including supervisory and consulting services, due to the failure of the Contractor to complete the work within the time specified.</p> <p>The said amount is fixed and agreed upon by and between Contractor and Owner because of the impracticality and extreme difficulty of fixing and ascertaining the actual damages Owner would in such event sustain, and said amount is agreed to be the amount of damages which the Owner would sustain.</p>

DIVISION 0 – PROCUREMENT AND CONTRACTING REQUIREMENTS

Section
Number

Title

It is further agreed that time is of the essence of each and every portion of this contract and of the specifications where a definite and certain length of time is fixed for the performance of any act whatsoever; and when under the Contract an additional time is allowed as hereinbefore mentioned for the completion of any Work, the new time limit fixed by such extension shall be of the essence of this Contract, provided that the Contractor shall not be charged with Liquidated Damages or any excess cost when the delay in completion of Work is due:

To unforeseeable cause beyond the control and without fault or negligence of the Contractor, including, but not restricted to, acts of God, or of the public enemy, acts of the Owner, acts of another Contractor in the performance of a contract with the Owner, fires, floods, epidemics, quarantine restrictions, strikes, freight embargoes, and unusually severe weather. The unusualness of the weather shall be determined by statistics from the local Weather Bureau over a period of the last 10 years. Upon request of the DP, the Contractor shall obtain statistical information from the Weather Bureau to support his claim for extension caused by unusual weather condition.

If the Contractor is delayed at any time in the progress of the Work by any act or neglect of the Owner or the DP, or by any separate Contractor employed by the Owner, or by changes in the Work, or by labor disputes, fire, unusual delay in transportation, unusually severe weather conditions, adverse soil conditions, unavoidable casualties, delays specifically authorized by the Owner, or by causes beyond the Contractor's control, avoidance, or mitigation, and without any fault or negligence of the Contractor or Subcontractor or Supplier at any tier, then the Contract Time shall be extended by Change Order for such reasonable time as the Owner may determine that such event has delayed the critical path of the Work or individual milestone or overall completion of the Work after considering the advice of the DP, if the Contractor complies with the notice and documentation requirements set forth below. The Contractor shall pay any additional fees or costs incurred by the Owner or DP as the result of delays caused by the Contractor for circumstances not excused as provided herein.

Initial notice of any delay in the Work shall be made in writing to the DP and Owner immediately but in no event later than 24 hours after discovery of the event giving rise to the delay. Then, Contractor shall provide additional details of the delay in writing to the DP and the Owner within seven (7) calendar days from the beginning of the delay. Failure to meet these time requirements shall absolutely bar any and all later claims. The detailed notice shall indicate the cause of the delay, the anticipated length of the delay, the probable effect of such delay upon the progress and cost of the Work, and potential mitigation plans. If the cause of the delay is continuing, the Contractor must give written notice every month at the same time it submits the updated progress Narrative Report to the DP. Within fifteen (15) days after the elimination of any such delay, the Contractor shall submit further documentation of the delay and, if applicable, a formal written request covering an extension of time for such delay. The written request for time extension shall state the cause of the delay, the number of days extension requested and provide a fully documented analysis of the Progress Schedule, including a fragment and any other data demonstrating a delay in the critical path of the Work or individual milestone or the overall project completion. If the Contractor does not comply

Section
Number

Title

with the notice and documentation requirements set forth above, the claim for delay is absolutely barred.

Schedule of Liquidated Damages shall be as follows:

Substantial Completion:

(Dollar Amount)

for every day beyond the scheduled date of Substantial Completion through to and including the date indicated on the Official Certificate of Substantial Completion when issued by the DP.

Final Completion:

(Dollar Amount)

for every day beyond the date of Final Completion as established in the Contract Documents and per the Construction Agreement. Work to be completed prior to a determination of Final Completion includes the fulfillment of all Contractual requirements, including the completion of all punch list items and Contract Closeout documents.

00 73 60

Value Engineering Change Proposals (VECP)

General

This clause applies to any cost reduction proposal (hereinafter referred to as a Value Engineering Change Proposal (VECP)) initiated and developed by the Contractor for changing the drawings, designs, specifications, or other requirements of this contract. This clause does not, however, apply to any such proposal unless it is identified as a VECP by the Contractor at the time of its submission to the Owner.

Definition

All VECP's must:

Result in a savings to the Owner by providing a decrease in the cost of the performance of this contract without impairing any required functions and characteristics such as service life, reliability, economy of operation, ease of maintenance, desired appearance, standardized feature, fire protection features, safety features.

Require, in order to be applied to this contract, a change order to this contract.

Proposal Screening

The Contractor will present anticipated proposals to the DP for proposal screening. During this screening, the DP will render an opinion as to the relative merits of the proposal.

The DP will provide as a part of the screening, the minimum technical content requirements to be submitted by the Contractor as a part of the formal VECP.

Concurrence by the Owner and the DP with merits of the proposal during the screening is not to be assumed that the VECP will automatically be accepted.

Section
Number

Title

In the event a VECP is received which has not had the proposal screening, it may be rejected without review.

VECP Content

As a minimum, the following information must be submitted by the Contractor with each VECP.

A description of the difference between the existing contract requirement and that proposed, the comparative advantages and disadvantages of each, a justification when an item's function or characteristics are being altered, and the effect of the change on the end item's performance. A list and analysis of the contract requirements that must be changed if the VECP is accepted, including any suggested specification revisions.

A separate, detailed cost estimate for (1) the affected portions of the existing contract requirement and (2) the VECP.

A description and estimate of costs the University may incur in implementing the VECP, such as test and evaluation and operating and support costs.

A prediction of any effects the proposed change would have on collateral costs to the agency.

A statement of the time by which a Change Order accepting the VECP must be issued in order to achieve the maximum cost reduction, noting any effect on the contract completion time or delivery schedule.

Identification of any previous submissions of the VECP, including the dates submitted, the agencies and contract numbers involved, and previous University actions, if known.

The Contractor may withdraw, in whole or in part, a VECP that has not been accepted by the Owner within the period specified in the VECP.

Owner Action

The DP shall notify the Contractor of the status of the VECP within 30 days after submitted for review. If additional review time is required, the DP shall notify the Contractor of this within the original 30-day period. The Owner or DP shall not be held liable for any delays in acting upon a VECP.

If a VECP is not accepted, the DP shall notify the Contractor in writing, explaining the reasons for rejection. The notice of rejection shall be submitted within the review period referenced above.

Any VECP may be accepted, in whole or in part by the Owner. The Owner may modify a VECP, with the concurrence of the Contractor, to make it more acceptable. If any modification

DIVISION 0 – PROCUREMENT AND CONTRACTING REQUIREMENTS

Section
Number

Title

increases or decreases the savings resulting from the VECP, the Contractor's fair share will be determined on the basis of the VECP as modified. Unless and until a change order applies a VECP to this contract, the Contractor will remain obligated to perform in accordance with the terms of the existing contract. The Owner may accept in whole or in part any VECP submitted pursuant to this clause by issuing a change order which will identify the VECP on which it is based.

****END OF SECTION****

Section Number	Title
01 00 00	GENERAL REQUIREMENTS
01 10 00	Summary
01 11 00	Summary of Work
01 11 13	Work Covered by Contract Documents
01 11 16	Work by Owner
01 12 00	Multiple Contract Summary
01 14 00	Work Restrictions
01 14 13	Access to Site
01 14 16	Coordination with Occupants
01 14 19	Use of Site
01 18 00	Project Utility Sources
01 18 13	Utility Service Connections
01 20 00	PRICE AND PAYMENT PROCEDURES
01 21 00	Allowances
01 22 00	Unit Prices
01 23 00	Alternates
01 25 00	Substitution Procedures
01 25 13	Product Substitution Procedures
01 25 16	Execution Substitution Procedures
01 26 00	Contract Modification Procedures
01 26 13	Requests for Interpretation
01 26 46	Construction Change Directives
01 26 53	Proposal Requests
01 26 54	Proposal Worksheet Summaries
01 26 57	Change Order Request
01 26 63	Change Orders
01 29 00	Payment Procedures
01 29 73	Schedule of Values
01 29 76	Progress Payment Procedures
01 29 83	Payment Procedures for Testing Laboratory Services
01 30 00	ADMINISTRATIVE REQUIREMENTS
01 31 00	Project Management and Coordination
01 31 13	Project Coordination
01 31 14	Facility Services Coordination
01 31 16	Multiple Contract Coordination
01 31 19	Project Meetings
01 31 19.13	Preconstruction Meetings
01 31 19.16	Site Mobilization Meetings
01 31 19.23	Progress Meetings
01 31 19.33	Pre-installation Meetings

Section Number	Title
01 31 26	Electronic Communication Protocols
01 32 00	Construction Progress Documentation
01 32 13	Scheduling of Work
01 32 16	Construction Progress Schedule
01 32 19	Submittals Schedule
01 32 23	Survey and Layout Data
01 32 26	Construction Progress Reporting
01 32 33	Photographic Documentation
01 32 43	Purchase Order Tracking
01 33 00	Submittal Procedures
01 33 13	Certificates
01 33 16	Design Data
01 33 19	Field Test Reporting
01 33 23	Shop Drawings, Product Data, and Samples
01 33 29	Sustainable Design Reporting
01 33 29.06	Reused Product Form
01 35 00	Special Procedures
01 35 13	Special Project Procedures
01 35 13.26	Special Project Procedures for Clean Rooms
01 35 13.43	Special Project Procedures for Contaminated Sites
01 35 23	Owner Safety Requirements
01 35 26	Governmental Safety Requirements
01 35 29	Health, Safety, and Emergency Response Procedures
01 35 29.13	Health, Safety, and Emergency Response Procedures for Contaminated Sites
01 35 43	Environmental Procedures
01 35 43.13	Environmental Procedures for Hazardous Materials
01 35 43.16	Environmental Procedures for Toxic Materials
01 35 46	Indoor Air Quality Procedures
01 35 53	Security Procedures
01 35 63	Sustainability Certification Project Requirements
01 35 66	Sustainability Certification Project Procedures
01 35 91	Historic Treatment Procedures
01 40 00	QUALITY REQUIREMENTS
01 41 00	Regulatory Requirements
01 41 13	Codes
01 41 16	Laws
01 41 19	Rules
01 41 23	Fees
01 41 26	Permit Requirements
01 43 00	Quality Assurance
01 43 23	Installer Qualifications

Section Number	Title
01 43 26	Testing and Inspecting Agency Qualifications
01 43 29	Code-Required Special Inspector Qualifications
01 45 00	Quality Control
01 45 23	Testing and Inspecting Services
01 45 26	Plant Inspection Procedures
01 45 33	Code-Required Special Inspections and Procedures
01 50 00	TEMPORARY FACILITIES AND CONTROLS
01 51 00	Temporary Utilities
01 51 13	Temporary Electricity
01 51 16	Temporary Fire Protection
01 51 23	Temporary Heating, Cooling, and Ventilating
01 51 26	Temporary Lighting
01 51 29	Temporary Natural-Gas
01 51 33	Temporary Telecommunications
01 51 36	Temporary Water
01 52 00	Construction Facilities
01 52 13	Field Offices and Sheds
01 52 19	Sanitary Facilities
01 54 00	Construction Aids
01 54 13	Temporary Elevators
01 54 16	Temporary Hoists
01 54 19	Temporary Cranes
01 54 23	Temporary Scaffolding and Platforms
01 54 26	Temporary Swing Staging
01 55 00	Vehicular Access and Parking
01 55 13	Temporary Access Roads
01 55 19	Temporary Parking Areas
01 55 26	Traffic Control
01 55 29	Staging Areas
01 56 00	Temporary Barriers and Enclosures
01 56 16	Temporary Dust Barriers
01 56 19	Temporary Noise Barriers
01 56 26	Temporary Fencing
01 56 39	Temporary Tree and Plant Protection
01 58 00	Project Identification
01 58 13	Temporary Project Signage
01 58 16	Temporary Interior Signage
01 60 00	PRODUCT REQUIREMENTS
01 61 00	Common Product Requirements
01 61 13	Software Licensing Requirements

Section Number	Title
01 66 00	Product Storage and Handling Requirements
01 70 00	EXECUTION AND CLOSEOUT REQUIREMENTS
01 73 00	Execution
01 73 29	Cutting and Patching
01 74 00	Cleaning and Waste Management
01 74 13	Progress Cleaning
01 74 16	Site Maintenance
01 74 19	Construction Waste Management and Disposal
01 74 23	Final Cleaning
01 75 00	Starting and Adjusting
01 75 13	Checkout Procedures
01 75 16	Startup Procedures
01 77 00	Closeout Procedures
01 77 13	Preliminary Closeout Reviews
01 77 16	Final Closeout Review
01 77 19	Closeout Requirements
01 78 00	Closeout Submittals
01 78 23	Operation and Maintenance Data
01 78 23.13	Operation Data
01 78 23.16	Maintenance Data
01 78 29	Final Site Survey
01 78 36	Warranties
01 78 39	Project Record Documents
01 78 43	Spare Parts
01 78 46	Extra Stock Materials
01 78 53	Sustainable Design Closeout Documentation
01 79 00	Demonstration and Training
01 80 00	PERFORMANCE REQUIREMENTS
01 81 00	Facility Performance Requirements
01 81 13	Sustainable Design Requirements
01 90 00	LIFE CYCLE ACTIVITIES
01 91 00	Commissioning
01 91 13	General Commissioning Requirements
01 92 00	Facility Operation
01 92 13	Facility Operation Procedures
01 93 00	Facility Maintenance
01 93 13	Facility Maintenance Procedures
01 00 00	GENERAL REQUIREMENTS

Section Number	Title
01 10 00	SUMMARY
01 11 00	Summary of Work
01 11 13	<p>Work Covered by Contract Documents</p> <p><i>This section is to include project specific information which will be provided by the DP.</i></p> <p>If using Division 1 for subcontractor bid packages the Contractor shall incorporate applicable language from Contractor’s Construction Agreement with Owner.</p>
01 11 16	<p>Work by Owner</p> <p><i>This section is to include project specific information which will be provided by the Project Manager if applicable.</i></p>
01 12 00	Multiple Contract Summary
	<i>This section is to list other contracts awarded within the project boundary, which will be provided by the DP/Owner (if applicable).</i>
01 14 00	Work Restrictions
01 14 13	<p>Access to Site</p> <p><i>This section is to include project specific information which will be provided by the DP.</i></p> <p>Truck washing stations, truck tire scraping grates and street sweeping may be required. Access to site shall be provided as to keep construction activity, dirt and mud on site.</p>
01 14 16	<p>Coordination with Occupants</p> <p>Communication with the occupants is to be sent through the Owner. Impact requests shall be requested a minimum of 5 business days prior to the proposed starting time. Requests may not be approved and may be rescheduled to meet occupant needs.</p>
01 14 19	<p>Use of Site</p> <p><i>This section is to include project specific information which will be provided by the DP.</i></p> <p>Use of the site is restricted to materials and equipment necessary to completion of the Work. It is the Contractor’s responsibility to ensure enclosure of the site from the general public.</p>

Section
Number

Title

01 18 00 Project Utility Sources

01 18 13 Utility Service Connections

This section is to include project specific information which will be provided by the DP.

The Contractor shall prearrange time with the DP and Owner whenever it becomes necessary to energize new services or interrupt any service to make connections, alterations or relocations and shall fully cooperate with the Owner in doing Work so as to cause the least annoyance and interference with the continuous operation of the Owner's business or official duties. Following this meeting the Contractor shall submit a work authorization request that will include a detailed description and procedure for each task, schedule for each task, any safety controls being implemented and signoff locations for tasks completed. The work authorization request will be similar to the document identified in 29 CFR 1910.147 App A and must be approved by the Owner (trade supervisor for the intended utility). The work authorization document is considered a submittal subject to the review periods indicated in the contract but in no case less than 5 business days, and must be approved prior to scheduling work.

Any existing utility distribution or internal plumbing, heating, ventilating, air conditioning or electrical disconnections which may affect portions of existing buildings or other construction projects must be coordinated with the DP and Owner to avoid any disruption of operation. While bidding, the Contractor shall assume that all shutdowns shall occur during afterhours and/or weekends unless specifically stated otherwise in the contract documents. In no case, unless previously approved in writing by Owner, shall utilities be left disconnected at the end of a work day or over a weekend. Any interruption of utilities shall be reported immediately to the Owner (Project Manager). Such interruptions, whether negligently, intentionally, or accidentally, shall not relieve the Contractor's responsibility for the interruption or from liability for loss or damage caused by such interruption even though such loss or damage was not foreseeable by Contractor or subcontractor, or from responsibility for repairing and restoring the utility to normal service. Repairs and restoration shall be made before the Contractor leaves the project site.

****END OF SECTION****

01 20 00 PRICE AND PAYMENT PROCEDURES

01 21 00 Allowances

Section Number	Title
	<p>The Contractor's price for the Work shall include all of the Contractor's costs associated with such allowance or allowances. If the actual costs to the Contractor of such allowance or allowances is different from the specified sum, increases or decreases in the cost of the allowance and associated Contractor's cost shall be adjusted in accordance with the Construction Agreement.</p> <p>Use of Allowances must be requested and approved through the Allowance Use Authorization form.</p>
01 22 00	<p>Unit Prices <i>This section is to include project specific information which will be provided by the DP.</i></p>
01 23 00	<p>Alternates <i>This section is to include project specific information which will be provided by the DP.</i></p>
01 26 00	<p>Contract Modification Procedures</p>
01 26 13	<p>Requests for Interpretation Requests for Interpretation (RFI) will be sent electronically to the Owner (Project Manager) and the DP concurrently. The RFI must indicate the Owner's project number, RFI #, spec section and plan sheet impacted, trades involved, images if applicable, a proposed solution and potential cost or time impact.</p>
01 26 46	<p>Construction Change Directives Use Owner form FS #16 for all Construction Change Directives (CCD). No changes in the work shall be undertaken by the Contractor without written direction by the Owner and DP (if a DP is on the project), either as a CCD or a Change Order.</p>
01 26 53	<p>Proposal Requests Refer to Section 01 26 57</p>
01 26 54	<p>Proposal Worksheet Summaries Refer to Section 01 26 57</p>
01 26 57	<p>Construction Change Proposal Request The CCPR form is required to be completed by the Contractor with a detailed description and cost breakdown for each individual requested change. Please</p>

Section Number	Title
	refer to FS#12 available at: http://nau.edu/Facility-Services/Planning/Forms-Index/ . Refer to construction agreement for specific provisions.
01 26 63	<p>Change Orders</p> <p>No changes in the work shall be undertaken by the Contractor without written direction by the Owner and DP (if a DP on the project), either as a CCD or a Change Order. Any changes made without such written direction are done so at the Contractor's own risk. Change Orders shall be processed as identified in the construction agreement.</p> <p>Change procedures must follow the requirements outlined in the Construction Agreement Between Owner and Contractor. A copy of the latest version of the Construction Agreement between Owner and Contractor is available at http://nau.edu/Facility-Services/DP Contract/. Change orders are on Owner form FS #14.</p>
01 29 00	Payment Procedures
01 29 73	<p>Schedule of Values</p> <p>Individual construction activities which are indicated by the Schedule of Values shall coincide with activities presented on the Contractor's Construction Schedule. Contractor shall submit proposed schedule of values for review and approval by DP and by Owner, per the Construction Agreement between Owner and Contractor, prior to submission of first pay application.</p>
01 29 76	<p>Progress Payment Procedures</p> <p>Contractor will submit payments electronically to the Project Manager, DP and Owner (project manager and project assistant) concurrently. Payments will be measured against the Schedule of Values as approved by the DP, Owner and CM (as applicable).</p> <p>For all Testing and Inspection Services, the Testing and Inspection Log (FS#105) shall be completed and shall accompany each pay app for that billing period.</p> <p>Payment procedures shall be per the Construction Agreement. The Pay Application form can be found at: http://nau.edu/Facility-Services/DP Contract/.</p>
	END OF SECTION
01 30 00	ADMINISTRATIVE REQUIREMENTS
01 31 00	Project Management and Coordination

Section Number	Title
01 31 13	<p>Project Coordination Project coordination and communication procedures will be discussed in detail at the preconstruction meeting. The minutes of this meeting shall serve as reference and documentation of proper coordination and communication channels.</p>
01 31 14	<p>Facility Services Coordination An emergency contact sheet will be provided to the Contractor with contacts for the Owner’s different departments in Facility Services. The Contractor will fill out with their emergency numbers and return to the Owner for distribution.</p>
01 31 16	<p>Multiple Contract Coordination The Owner reserves the right to award other contracts related to the Project, or to perform certain work itself. Any such other work may or may not be known to the Owner or disclosed to the Contractor prior to execution of the Agreement. The Contractor shall allow the Owner and such other additional contractors to deliver and store the additional contractors’ or Owner’s materials and equipment and to execute the additional contractors’ or Owner’s work, and shall properly coordinate the Contractor’s Work with the additional contractors’ or Owner’s work in such manner as the Owner or Design Professional may direct. The Contractor shall also assure at the Contractor’s own cost reasonable access of additional contractors to the Contractor’s site and the Contractor’s work.</p>
01 31 19	<p>Project Meetings Refer to the required project meetings in the Construction Agreement.</p>
01 31 19.13	<p>Preconstruction Meetings A preconstruction meeting shall be held for all projects. Notification of the time and date of such conference shall be made to the selected Contractor in the Notice of Intent to Award, or via other coordination methods. The preconstruction meeting agenda (FS #21) is located online at: http://nau.edu/Facility-Services/Planning/Forms-Index/.</p>
01 31 19.14	<p>Inspection Meeting A meeting will be held between Owner (including Project Manager, Building Official, applicable Trades Inspectors) and the Contractor to discuss inspection procedures and establish expectations. This may be a separate meeting from the preconstruction meeting or may be covered in the preconstruction meeting.</p>
01 31 19.15	<p>Blue Stake Meeting</p>

Section Number	Title
	Contractor and earthwork/underground foreman will coordinate a Blue Stake Kickoff Meeting prior to the start of Work to review the proposed schedule and blue stake requirements. This is a separate meeting from the preconstruction meeting.
01 31 19.16	Site Mobilization Meetings
01 31 19.23	<p>Progress Meetings</p> <p>Progress meetings shall occur on a regular basis (weekly) according to a schedule determined at the pre-construction conference or as established in the contract.</p>
01 31 19.33	<p>Pre-Installation Meetings</p> <p>The Contractor shall schedule a pre-installation meeting before starting any trade work in the field, between the Owner’s Trade Inspector(s), the Contractor and subcontractor(s). The contractor performing the work (which may be the Contractor if self-performing or a subcontractor) must be in attendance at this meeting. The pre-installation meeting will review the installation and inspection protocol (quality control, workmanship expectations, means and methods etc.) and review project specifications and drawings with the Contractor and subcontractor(s). The pre-installation meetings shall be specified when applicable for the following work:</p> <ul style="list-style-type: none"> • Concrete formwork and placing • Waterproofing • Mortar / masonry • Flashing • Roofing • Sealant • Vapor Barrier • Painting and Drywall • Fire Sprinkler • Fire Alarm • HVAC • Plumbing • Electrical • Datacomm/ITS • Site Utilities • Refer to FS #15 for additional requirements • Owner may require additional pre-installation meetings depending on the scope of work.

Section Number	Title
	Acknowledgement of the Pre-Installation Meeting is required on the FS15 form prior to any inspections being performed.
	Contractor shall schedule a subsequent inspection when 10 – 15% of the work reviewed in the pre-installation meeting to verify proper installation practices are implemented.
01 31 26	Electronic Communication Protocols All communications on the project are to go through the Owner’s Project Manager.
01 32 00	Construction Progress Documentation
01 32 13	Scheduling of Work In general, hours of construction activity shall be limited to 7 a.m. until 7 p.m., Monday through Friday, unless written approval is obtained from Owner (Project Manager). Additionally, the Contractor shall agree to limit any noisy activities during “reading week” and “finals week”. Reading Week and Finals Week generally occur during the first weeks of May and December. Year-round, project work adjacent to or within Residence Halls shall be more strictly limited to the hours of 8:00 a.m. until 6:00 p.m, unless written approval is obtained from the Owner. In addition to these hours, work performed on weekends will not be permitted without prior authorization from Owner.
01 32 16	Construction Progress Schedule The following requirements shall support and amplify the requirements of the Construction Agreement between Owner and Contractor. In conjunction with the Contractor’s construction schedule, the Contractor shall provide a procurement schedule for all major project components to be purchased and incorporated by the Contractor into the project. The procurement schedule shall indicate scheduled delivery of major project components, both equipment and materials, in support of the activities included on the Contractor’s construction schedule. Revisions to the Contractor’s construction schedule shall be coordinated with revisions to the procurement schedule. In the event significant delays or lags in schedule, as determined by the Owner, are encountered, the Contractor shall provide to the Owner a revised

Section Number	Title
	<p>Contractor’s Construction Schedule indicating proposed rescheduling of subsequent activities to achieve project completion by the Contract Completion Time or Amended Completion Time.</p> <p>Additions to or deletions from the Contract, authorized through Change Orders, shall be reflected in the Contractor’s construction schedule.</p> <p><u>Owner’s Approval of Phasing</u> The Owner reserves the right to review and approve scheduling or phasing of construction activities.</p> <p>Contractor shall be aware of the impact of construction activities on Owner’s functions and operations and shall advise the Owner when they may be impacted by the schedule. The Contractor shall act to lessen or avert impact to Owner operations through alternative phasing of activities or other measures.</p>
01 32 19	<p>Submittals Schedule</p> <p>The Contractor is required to make submittals for the DP and Owner review in a prompt and timely manner. A schedule of submittals is to be delivered to the Owner within XX days of the notice to proceed. Submittals are required for each subsection detailed in the individual sections of Divisions 2 through 48.</p>
01 32 23	<p>Survey and Layout Data</p> <p><i>This information to be provided by Design Professional.</i></p> <p>All underground utilities installed or exposed by Contractor shall have GPS points taken and indicated on the as-builts with utility descriptor, pipe size, material, and any other pertinent data. Points shall include any connections, valves, bends, rises/falls and points where other utilities are crossed. In the event that existing utilities are exposed during construction then 1 GPS point will be taken for every 10’ of exposed surface in addition to any connections, valves, bends, rises/falls and points where other utilities are crossed.</p>
01 32 26	<p>Construction Progress Reporting</p> <p>The Contractor shall maintain a written daily log in accordance with the Construction Agreement.</p>
01 32 33	<p>Photographic Documentation</p> <p>Photos are required on projects as determined by Owner, submitted electronically with pay application, and representative of the work for which the pay application is for. Photographs shall be a minimum of 5 megapixels. A description of photos required will be discussed at the preconstruction meeting.</p>

Section Number	Title
01 32 43	<p>The photo's file name shall be labeled with first the location of the photo, direction of view and then description. Exterior locations must provide the location with GPS coordinates.</p> <p>Procurement Tracking Included in the Contractor's critical path schedule, the Contractor shall provide procurement durations for all major project components (equipment and material) to be purchased (regardless if purchased by Owner or Contractor).</p> <p>Expediting reports/schedule corrections shall be provided by the Contractor to the Owner in the event that scheduled deliveries, of a significant nature, do not arrive as planned and the Contractor shall make all reasonable effort to expedite deliveries in accordance with the original schedule.</p> <p>Time submitted by the Contractor on the basis of delayed material or equipment deliveries, shall be accompanied by documentation from the vendor/supplier indicating the date order was placed, usual time required for delivery and the date of scheduled delivery.</p>
01 33 00	<p>Submittal Procedures Provide complete submittals. Diagrams shall show installed component model numbers; block diagrams do not constitute an acceptable schematic. There shall be a separate submittal for each of the first-4 digits of the CSI divisions, as needed. For example, a separate submittal is needed for Division 26 05 as opposed to a submittal for Division 26 09.</p>
01 33 13	<p>Certificates <i>This section is to include project specific information which will be provided by the DP if applicable.</i></p>
01 33 16	<p>Design Data</p>
01 33 19	<p>Field Test Reporting Copies of Field Test Reports will be turned over monthly along with the Pay Application.</p>
01 33 23	<p>Shop Drawings, Product Data, and Samples The Submittal Procedure shall be per the requirements of the Construction Agreement.</p>
01 33 29	<p>Sustainable Design Reporting</p>

Section Number	Title
01 33 29.06	<p>Reused Product Form</p> <p><i>This section is to include project specific information which will be provided by the Owner on property control number information, if applicable.</i></p>
01 35 00	Special Procedures
01 35 13	<p>Special Project Procedures</p> <p><i>This section is to include project specific information which will be provided by the DP if applicable.</i></p>
01 35 13.26	<p>Special Project Procedures for Clean Rooms</p> <p><i>This section is to include project specific information which will be provided by the DP if applicable.</i></p>
01 35 13.43	<p>Special Project Procedures for Contaminated Sites</p> <p><i>This section is to include project specific information which will be provided by the DP if applicable.</i></p>
01 35 23	<p>Owner Safety Requirements</p> <p>The Contractor's responsibility for project safety is according to the Construction Agreement, which includes submitting a written safety plan to Owner and DP. This safety plan shall include the name and contact information of the contractor/vendor safety officer, emergency contact information, information on hazards likely to be encountered on the work site, work site PPE requirements, and any safety training requirements, training logs or proof of certification, and Job Hazard Analyses (JHA's) for the planned activities (Blank JHA forms may be downloaded from http://nau.edu/Facility-Services/Contractor-Safety-Plans/). The Contractor shall be responsible for initiating, maintaining and supervising all safety precautions and programs in connection with Contractor's Work.</p> <p>The Contractor shall designate an employee as Safety Officer at the Project Site whose duties shall include prevention of accidents and monitoring/enforcement of the Contractor's safety program.</p> <p>The Contractor's Safety Officer shall attend the preconstruction meeting.</p> <p>The Contractor's Safety Officer will be responsible for continued monitoring of the job site to maintain safe working conditions in strict compliance with <u>State of Arizona Occupational Safety and Health Standards for the Construction Industry</u> (29 CFR Part 1926). Specific attention is called to Housekeeping (Section 1926.25, ADOSH, 29 CFR Part 1926).</p>

Section Number	Title
	<p>The Contractor and all subcontractors shall clear away all debris which poses an unsafe condition as required in Section 1926.25 on a <u>daily</u> basis.</p> <p>Failure of the Contractor to promptly correct unsafe conditions, subsequent to written notification by the Owner, shall constitute violation of the standards indicated herein. The Owner reserves the right, in the event of such violation, to correct unsafe conditions through the most expedient means available. Any costs incurred by the Owner for such corrective work shall be reimbursed by the Contractor, via deductive Change Order.</p>
01 35 26	<p>Governmental Safety Requirements All employees of the Contractor or subcontractors shall have adequate safety training for their respective facets of the work as specifically required by document #2254, <u>Training Requirements and OSHA Standards and Training Guidelines</u> (USDA, OSHA 1985).</p>
01 35 29	<p>Health, Safety, and Emergency Response Procedures NAU's Emergency Response Call Sheet can be found at: http://nau.edu/Facility-Services/DP_Contract/</p>
01 35 29.13	<p>Health, Safety, and Emergency Response Procedures for Contaminated Sites <i>This information can be obtained from the Owner's Office of Environmental Health & Safety.</i></p>
01 35 43	<p>Environmental Procedures The Owner shall have first right of refusal on all materials and equipment which are removed as part of the Project construction process to include materials both above and below the existing ground surface.</p> <p>Contractor shall notify the Owner prior to disposing of such materials and equipment. Owner will notify the Contractor promptly if possession is to be taken by the Owner.</p> <p>Materials not claimed by the Owner within three working days shall be removed from the Project site by the Contractor and disposed of appropriately.</p> <p><u>Hazardous Materials Procedures</u> The Contractor shall inform Owner (Office of Environmental Health & Safety (EH&S) and the Project Manager) of any hazardous chemicals they will be using on campus. The Contractor shall comply with the requirements specified in OSHA's Hazard Communication program (29 CFR 1910.1200). The Contractor shall assume responsibility for the safe and legal disposal of all chemicals used</p>

Section
Number

Title

on the job site. If any hazardous waste is generated on site as a result of a project, please contact Owner (EH&S) for determination of whether the waste must be disposed of in accordance with EPA regulations.

Lead Abatement

This information can be obtained from the Owner (EH&S).

Asbestos Abatement

NAU has completed asbestos surveys for the majority of buildings currently present on the Flagstaff Campus and remote campuses. Survey results are housed in the NAU Asbestos Program office and are available for review or notification purposes.

To maintain compliance with all applicable state and Federal EPA and OSHA regulations, Owner’s policy requires that a site specific asbestos inspection be completed to determine the need for abatement before any work involving the disturbance of pre-existing building components is conducted. This inspection and any other required asbestos information and guidance may be requested directly by calling the Material Safety office at (928) 523-6435, or by completing the online asbestos inspection request (<http://nau.edu/Facility-Services/Planning/Asbestos,-Lead,-and-PCBs/>.) Asbestos inspections may involve additional sampling of previously untested materials, and may facilitate the need for NESHAP notified abatement work, so an appropriate amount of lead time must be allotted in the project schedule.

All asbestos-containing materials (ACM) which are scheduled for disturbance are to be removed, containerized, and disposed of in accordance with all applicable Federal, State, and Local regulations. This work must be performed by NAU or by a licensed asbestos abatement contractor before any other work which may impact the materials in question. Work must be scheduled and performed in a manner which minimizes the chance of contamination of non-asbestos materials. The asbestos removal work must comply with the NESHAP (40 CFR 61, subpart M), AHERA (40 CFR 763, subpart E), and OSHA Asbestos construction standard (29 CFR 1926.1101) and general industry standard (29 CFR 1910.1001), whichever may apply.

Abatement activities are the responsibility of Owner and may not be subcontracted as part of the larger construction project without prior authorization from the Owner’s Material Safety Office. In cases which abatement is performed by the Contractor, or by a subcontractor retained by the Contractor, the Contractor or abatement subcontractor must meet the minimum qualifications and insurance for abatement contractors under the Arizona state

Section
Number

Title

purchasing system. When abatement is necessary, the Owner’s Project Manager will work in cooperation with Owner’s EH&S to develop specifications, collect bids, and contract/complete any necessary abatement independently from the larger construction contract and unless otherwise authorized by Owner (EH&S), abatement shall be completed prior to any other construction activities at the work site.

Oversight for abatement services shall be conducted by Owner, or by an approved third party oversight contractor. No additional demolition or renovation activities may proceed in the selected abatement area until appropriate clearance of the work by the oversight contractor and/or Owner. The oversight contractor or Owner will have the authority to stop work immediately if abatement or demolition procedures are found to be inadequate to control the release of asbestos fibers, or if asbestos is being disturbed in an uncontrolled or unsafe manner.

Owner will issue a written or verbal authorization to proceed with non-asbestos demolition/renovation activities following achievement of acceptable clearance of the asbestos abatement. Prior to authorization to proceed, the oversight contractor or Owner (Asbestos Program Manager) must complete a visual inspection and/or analytical sampling of the area to document completeness of the work. If contamination is found following abatement, the abatement contractor will be required to perform additional cleaning until acceptable levels are achieved, at no additional cost to the Owner. No other non-asbestos work may commence until all necessary abatement has been completed and authorization to proceed has been furnished by the Owner (Material Safety office).

It is the responsibility of the construction or demolition contractor to furnish an accurate work schedule to the Owner in order to allow for timely abatement and good coordination between vendors. The construction/demolition contractor may be held accountable for additional fees incurred by the Owner due to improper scheduling or communication on the part of the Contractor.

Following completion of all abatement activities, the abatement/oversight contractor shall provide copies of closeout documents including the date, location, and scope of work, negative exposure assessment and air sampling data, daily logs, and waste shipment records. Copies of all closeout documents shall be furnished to both the Owner’s Project Manager and Owner’s Material Safety office.

Section
Number

Title

To satisfy its obligations under OSHA, Owner will issue a written notification of the presence of asbestos and other hazards in the work area and building which work is being conducted in; and specific abatement requirements which may be required for the project. The Contractor is responsible for the health and safety of its own employees and for meeting OSHA communication of hazard, training, and PPE requirements. Worker compliance with all applicable regulations will be enforced by the Contractor.

The Contractor shall comply with:

The National Emission Standard for Hazardous Air Pollutants (NESHAP), 40 CFR 61, subpart M, enforced by the Arizona Department of Environmental Quality, regulating the removal and disposal of asbestos-containing materials.

The abatement contractor will be required to notify the State of Arizona Department of Environmental Quality NESHAP office 10 business days before removal of threshold amounts of friable asbestos or RACM as specified in 40 CFR 61.145. The Contractor shall send a copy of this notice to the Owner’s Asbestos Program Manager. A NESHAP notification is also required 10 days prior to commencement of demolition of any building on Owner campus even if no asbestos abatement is required. Filing of the Demolition NESHAP notification is the responsibility of the demolition or construction contractor.

During and following completion of the renovation, all newly installed building materials shall be analyzed for asbestos and a report containing the analytical results shall be furnished to the Owner’s Material Safety Office to maintain complete records of NAU buildings in the future. Testing shall conform to the guidelines set forth in the EPA AHERA regulation. This testing shall be conducted by an AHERA certified building inspector and if requested, shall be conducted by the renovation/construction contractor. This is an inspection sign off item in the Owner’s FS #15 form and final sign off will not be furnished without completion of the inspection and review of the resulting report by the Owner’s Material Safety office.

Blasting Policy

Blasting is not a preferred process on campus. Any use of explosives must be approved in writing by NAU Fire Marshal and must conform to The City of Flagstaff policies and procedures. The City of Flagstaff maintains jurisdiction for all blasting.

Section Number	Title
	<p>The Contractor shall submit to Owner prior to any blasting, appropriate employee certification for use of explosives.</p> <p>No explosives will be stored on the campus overnight or weekends. No quantity of explosives will be brought to the campus beyond that which will be used on the day blasting operations are to be performed.</p> <p>No blasting shall take place earlier than 8 a.m. or later than 5 p.m.</p>
01 35 43.13	<p>Environmental Procedures for Hazardous Materials</p> <p><i>This section is to include project specific information which will be provided by the DP if applicable.</i></p>
01 35 43.16	<p>Environmental Procedures for Toxic Materials</p> <p><i>This section is to include project specific information which will be provided by the DP if applicable.</i></p>
01 35 46	<p>Indoor Air Quality Procedures</p> <p><i>If a project is for a renovation, the DP shall indicate how to isolate the space to protect the indoor air quality of the rest of the building.</i></p>
01 35 53	<p>Security Procedures</p> <p>Contractor is responsible for securing access to all construction areas to prevent damage or theft. This may include but is not limited to securing site fencing, temporary construction and building entrances. Work within tunnels must be in accordance with 01 41 19 Rules.</p> <p>Refer to Construction Agreement for any additional security requirements.</p>
01 35 63	<p>Sustainability Certification Project Requirements</p> <p><i>This section is to include project specific information which will be provided by the DP if applicable.</i></p>
01 35 66	<p>Sustainability Certification Project Procedures</p> <p><i>This section is to include project specific information which will be provided by the DP if applicable.</i> Agnes Drogi and Owner's Project Manager are to be listed as the NAU administrator for the UGBC LEED website login.</p>
01 35 91	<p>Historic Treatment Procedures</p> <p><i>This section is to include project specific information which will be provided by the DP if applicable.</i></p>

Section
Number Title

****END OF SECTION****

Section
Number

Title

01 40 00 **QUALITY REQUIREMENTS**

01 41 00 **Regulatory Requirements**

Any work performed on or within the boundaries of the Northern Arizona University campus shall be subject to special inspections, periodic inspections, Code compliance inspections, and pre-occupancy and/or final inspections by the following agencies as applicable:

- State Fire Marshal's Office
- Arizona Corporation Commission
- State Boiler Inspector
- State Risk Management Division
- City of Flagstaff, including Dark Sky ordinance
- Coconino County
- State Elevator Inspector
- NAU Facility Services
- National Emissions Standards for Hazardous Air Pollutants (NESHAP)
- Arizona Department of Environmental Quality

It is the responsibility of the Contractor to provide a complete copy of the construction plans, specifications and other pertinent documents as necessary for review and approval by the necessary agencies.

No construction shall commence until the Contractor receives from NAU Fire Marshal and NAU Building Official the approved stamped copy of the construction plans, permit, and other documents provided.

01 41 13 **Codes and Standards**

All design and construction work shall be done in such a manner that the completion of project is in compliance with the following codes and standards the Owner has adopted as code. When reference is made to "this code" it shall mean all the codes listed below. In the event there is a conflict between any of these codes and standards, the most restrictive code shall apply.

- International Building Code 2012 (IBC)
- International Existing Building Code 2012 (IEBC)
- International Plumbing Code 2012 (IPC)
- International Mechanical Code 2012 (IMC)
- National Electrical Code 2011 (NEC) (NFPA 70)
- International Fuel Gas Code 2012 (IFGC)
- International Fire Code 2012 (IFC)
- National Fire Alarm Code 2013 (NFPA 72)

DIVISION 1 – GENERAL REQUIREMENTS

Section Number	Title
	<ul style="list-style-type: none">• Installation of Sprinkler Systems 2013 (NFPA 13)• NAU Fire Code (Most recent edition unless otherwise required)• Arizona State Fire Code• 2010 ADA Standards for Accessible Design as approved by the Department of Justice on July 26, 2010 (published in the Federal Register on September 15, 2010) and any more recent related Federal and State requirements with their related standards as they may apply.• ICC/ANSI, A117.1 – 2009, Accessible and Usable Buildings and Facilities.<ul style="list-style-type: none">○ FYI: Please be advised that where there is a conflict between any applicable accessibility requirements the most restrictive shall apply (e.g. 2012 IBC, 2010 ADA, 2009 ICC/ANSI A117.1, other NAU, State & Federal requirements, etc.).• 2007 American Society of Mechanical Engineers (ASME) A17.1, Safety Codes for Elevators and Escalators (unless otherwise required)<ul style="list-style-type: none">○ AZ Elevator Act (Title 23, Chapter 2, Article 12)○ Latest ADOSH Arizona Elevator Rules• AZ Executive Order 2008-29 (FYI: Reaffirms Executive Order 2005-05. Requires all new state-funded buildings to meet the Silver LEED standard, at a minimum.)• American Society of Heating, Refrigeration, and Air Conditioning Engineers (ASHRAE) 55 2010• ASHRAE 62.1 2010• ASHRAE 90.1 - 2010• ASHRAE 189.1 - 2014• ASHRAE 202 (Most recent edition unless otherwise required by Owner)• Arizona Revised Statutes (ARS)• Occupational Safety and Health Administration Regulations• NAU Material Safety Policies (e.g. Program Manuals such as Asbestos, Lead, PCB, etc.) (Most recent edition unless otherwise required) http://nau.edu/Research/Compliance/Environmental-Health-and-Safety/• IAQ Guidelines for Occupied Buildings Under Construction (Most recent edition unless otherwise required)• ACGIH Industrial Ventilation Manual of Recommended Practices (Most recent edition unless otherwise required)• ANSI/AIHA Z9.5 Laboratory Ventilation (Most recent edition unless otherwise required)• NAU Design Guidelines and Technical Standards (Most recent edition unless otherwise required)

Compliance shall conform to the requirements of the latest editions of all state regulations and the various codes which have been adopted by the University at the time of selection of the Design Professional (or at time of bid if the University

Section
Number

Title

does not designate a Design Professional), unless otherwise required by Federal or State regulation (such as ADA code compliance which is required at time of bid).

Contractor will be held to have examined and to have become familiar with these regulations in all ways they apply to the project.

If a conflict is found between any Code requirement and information given in written or graphic specifications, Contractor will abide by the more stringent of the two. Such conflict shall be reported in writing to the DP and to Owner (NAU Fire Marshal, Building Official, and PM).

The issuance of approved plans, specifications, and computations shall not be construed to be a permit for, or an approval of, any violation of any of the provisions of the above-listed codes, the NAU Fire Prevention Manual or the NAU Design Guidelines and Technical Standards.

The issuance of approved plans, specifications, and other data shall not prevent Facility Services from thereafter requiring the correction of errors in said plans, specifications and other data, nor shall issuance of such approved plans, specifications, or other data preclude the prevention of building operations being carried on there under when in violation of the above-listed codes.

01 41 16

Laws

By signing a contract with Owner or as a subcontractor to a general contractor that has a contract with Owner, the Contractor agrees to follow Owner's Blue Stake procedure under ARS 40-360.22-K.

It is the responsibility of the Contractor to make all utility staking requests. To request utility staking for any project the Contractor must call the Arizona811 Center and email Owner, per Blue Stake request form. All requests are given a log number. It is the Contractor's responsibility to note that number for future reference.

For the complete Blue Stake Procedure, Contractor shall refer to http://nau.edu/Facility-Services/DP_Contract/

DO NOT DIG UNTIL BLUE STAKING HAS BEEN CLEARED! ALL KNOWN UTILITIES MUST BE POTHOLED!

Section Number	Title
	<p>If the excavation phase is more than a month prior to substantial completion, Contractor shall remove the blue stake marks outside of the fenced area at the end of the excavation phase in a manner that does not damage finished surfaces. All projects will remove blue stake marks at substantial completion in a manner that does not damage finished surfaces.</p>
01 41 19	<p>Rules</p> <p>The tunnels on campus are generally considered a non-permit required confined space. However, conditions may change without Owner knowledge. Prior to entry, contractors must supply their own atmospheric tester/monitor, complete an NAU Confined Space Entry Checklist, and submit this checklist to their safety officer and the Owner’s project manager. If through utilization of the checklist the area is to be considered a confined space, then the contractor is responsible for their confined space safety program. This must be submitted to the Owner’s project manager for documentation. Owner’s confined space program is located here:</p> <p>https://nau.edu/uploadedFiles/Administrative/Research/Compliance/Environmental Health and Safety/Forms/ConfinedSpaceProgram.2.pdf</p> <p>No one may enter the tunnel system alone. Anyone entering the tunnel system must make contact with Owner (PM and appropriate plant operator) to provide the section of tunnel being accessed, time of entry, purpose of work and approximate time frame. Contact must be made with the appropriate Owner (plant operator) when leaving the tunnels as well.</p> <p>The entry checklist can be found at:</p> <p>https://nau.edu/uploadedFiles/Administrative/Research/Compliance/Environmental Health and Safety/Forms/NAUentrychecklist.pdf</p>
01 41 23	<p>Fees</p> <p>If a Contractor requires a reinspection because the Contractor is unprepared for the initial inspection, a fee will be assessed. The fee will be charged at the inspector’s chargeout rate per hour spent, and no less than \$200. This will be the Contractor’s expense.</p>
01 41 26	<p>Permit Requirements</p> <p>NAU permit requirements and applications can be found at:</p> <p>http://nau.edu/Facility-Services/DP_Contract/</p>
01 43 00	Quality Assurance

Section Number	Title
01 43 23	<p>Installer Qualifications</p> <p>This section is to include project specific information which will be provided by the DP.</p>
01 43 26	<p>Testing and Inspecting Agency Qualifications</p> <p>This section is to include project specific information which will be provided by the DP for the purposes of NAU's ARQ inspection selections.</p>
01 43 29	<p>Code-Required Special Inspector Qualifications</p> <p>This section is to include project specific information which will be provided by the DP for the purposes of NAU's ARQ inspection selections.</p>
01 45 00	Quality Control
01 45 23	<p>Testing and Inspecting Services</p> <p>Please refer to http://nau.edu/Facility-Services/DP_Contract/ for the complete detail of inspection procedures.</p> <p>Re-inspection of uncompleted work shall be at the Contractor's expense. See 01 41 23.</p> <p>All Work must be inspected and accepted by Owner. Any work required to be inspected which is covered prior to inspection, must be uncovered by Contractor at Contractor's expense.</p> <p>Reinforcing steel or structural framework of any part of any building or structure shall not be covered or concealed without first obtaining approval of the DP or Structural Engineer.</p> <p>Foundation Inspection: To be made after excavations for footings are complete and any required reinforcing steel is in place. For concrete foundations, any required forms shall be in place prior to inspection.</p> <p>Concrete Slab or Under-Floor Inspection: To be made after all in-slab or under-floor building service equipment, conduit, piping accessories and other ancillary equipment items are in place, but before any concrete is placed or floor sheathing installed, including the sub-floor.</p> <p>Frame and Rough-In Mechanical, Plumbing and Electrical Inspection: To be made after the roof, all framing, fire blocking and bracing are in place and all pipes, chimneys and vents are complete and the rough electrical, plumbing, and heating, pipes and ducts, and fire sprinkler piping are approved.</p>

Section Number	Title
	<p>Lath and/or Gypsum Board Inspection: To be made after all lathing and gypsum board, interior and exterior, is in place but before any plastering is applied or before gypsum board joints and fasteners are taped and finished.</p> <p>Substantial Completion Inspection: Prior to issuance of the Substantial Completion Certificate, all required in progress inspections listed in form FS#15 shall be passed. The Contractor must schedule a walkthrough with each trade inspector individually to sign off on the substantial completion lines of the FS#15 and provide a punch list.</p> <p>Final Completion Inspection: Prior to Final Payment the Contractor must schedule an additional walk with each trade inspector ensure that all punch work is completed and inspected, and all required inspections listed in form FS#15 shall be passed.</p>
01 45 26	<p>Plant Inspection Procedures Materials must be inspected by Owner (Landscape Architect) prior to install.</p>
01 45 33	<p>Code-Required Special Inspections and Procedures DP to specify which are needed on the project.</p>

****END OF SECTION****

Section Number	Title
01 50 00	TEMPORARY FACILITIES AND CONTROLS
01 51 00	Temporary Utilities Temporary construction utility connections are to be approved by Owner (Utility Services department) and shall be metered.
01 51 13	Temporary Electricity DP to specify.
01 51 16	Temporary Fire Protection DP to specify.
01 51 23	Temporary Heating, Cooling, and Ventilating DP to specify.
01 51 26	Temporary Lighting DP to specify.
01 51 29	Temporary Natural-Gas Temporary natural gas is not allowed. Propane may be used for temporary heating.
01 51 33	Temporary Telecommunications Temporary telephone service is available through Owner. Contractor is responsible for all connection, maintenance, and service fees.
01 51 36	Temporary Water Temporary water connections must have a back flow prevention device with meter, obtained from Owner (Plumbing department) and installed by the Contractor.
01 52 00	Construction Facilities The Contractor shall provide a staging plan/site logistic plan at the preconstruction meeting. The staging plan shall clearly identify the following items: <ul style="list-style-type: none"> • Construction Trailer • Material Staging • Wash down areas (concrete, mud, etc.) • Dumpsters • Traffic Control including signals and barricades • Signage • Site Fencing including gate locations and height of the fence

Section Number	Title
	<ul style="list-style-type: none"> • Site Access for contractors, material delivery and waste haul off • Sanitary Facilities • Temporary Utilities • Temporary Parking • SWPPP measures • ADA accessible routes • Pedestrian/bikes routes • Vehicle routes • Emergency Access <p>Any other provision, direction or accommodation agreed to and approved by Owner, the Contractor and DP, shall be clearly noted and conveyed on the staging/site demolition plan.</p>
01 52 13	<p>Field Offices and Sheds</p> <p>Location of field office must be approved by Owner. All utilities to the field office must be metered. Area must be restored to its original condition when field office is removed, including demolition of utilities back to the source.</p>
01 52 19	<p>Sanitary Facilities</p> <p>Contractors shall not use Owner’s sanitary facilities. Contractors are responsible for providing and maintaining adequate temporary sanitation facilities and indicate location(s) on the site logistics plan.</p>
01 55 00	Vehicular Access and Parking
01 55 13	<p>Temporary Access Roads</p> <p>Optimum truck routes and access roads, including fire department access, to the Project site shall be identified at the pre-construction conference and noted in the site logistics plan.</p>
01 55 19	<p>Temporary Parking Areas</p> <p>All persons driving or parking on the NAU campus are subject to NAU parking regulations. Owner’s parking policies are available at http://nau.edu/Parking-Shuttle-Services/Policies/.</p> <p>All vehicles parking within campus boundaries must display permits. Vehicles without permits will be ticketed by the NAU Police Department or Parking Services. Vehicles parked within the fenced staging / storage area, identified on the Construction Documents, do require parking permits. The Contractor will be required to make a written request to the Owner (Project Manager) at the preconstruction meeting for parking permits for all vehicles to be parked within the campus boundaries. NAU Parking Services will attempt to meet requests for</p>

DIVISION 1 – GENERAL REQUIREMENTS

Section Number	Title
	specific parking areas, however, due to availability; alternative parking areas may be assigned. Storage / Staging areas will be requested in writing to the Owner (Project Manager) prior to bidding. They are not guaranteed to be approved where requested, but Owner will attempt to make the best accommodations possible.
01 55 26	<p>Traffic Control</p> <p>All traffic control shall be coordinated with the Owner’s Project Manager, and shall be approved by: NAU Parking Services, NAU Shuttle Services, NAU Police Department, NAU Fire Marshal, NAU Office of Environmental Health & Safety and City of Flagstaff Fire Department.</p> <p>All proposed traffic control plans or modifications shall be submitted to the Owner’s Project Manager five (5) working days prior to the change and receive approval, as stated above.</p>
01 55 29	<p>Staging Areas</p> <p>The Contractor shall submit a site logistics plan at the preconstruction meeting. Storage / Staging Areas must be maintained and returned to the condition they were in prior to occupation by the Contractor. Patch, repair or replace any and all damaged areas upon completion of the work. The area must receive final inspection and approval by the Owner prior to final payment.</p>
01 56 00	Temporary Barriers and Enclosures
01 56 16	<p>Temporary Dust Barriers</p> <p>Dust control is the Contractor’s responsibility at no additional cost to the Owner. The Contractor shall address complaints regarding dust control within four (4) hours. Air, water, surface, and subgrade conditions shall be protected from pollution by the Contractor. Such protection requirements as detailed in all State and Federal regulations shall apply. Arizona State DEQ, OSHA, and NAU Office of Environmental Health & Safety may inspect for compliance without notice.</p>
01 56 19	<p>Temporary Noise Barriers</p> <p><i>This information to be provided by Design Professional (if applicable)</i></p>
01 56 26	<p>Temporary Fencing</p> <p><u>Project Site Fencing</u></p> <p>Contractor shall erect and maintain in good condition a six-foot high chain link fence of standard construction surrounding the Project site and enclosing the area of work and materials staging. Location of the fence shall be approved by</p>

Section
Number

Title

the Owner prior to erection. Fence gates shall remain locked when unattended to discourage access by unauthorized persons.

This applies to large construction projects and small projects with multiple locations.

Staging Area Fencing

A commercial grade chain-link fence around the entire perimeter of the staging area will be required.

The fence may be ground-set or tee supported, but must remain stable in high or gust wind conditions and scaling by pedestrians. The Contractor shall coordinate all fence pole locations that are to be pounded into the ground with Owner's Landscape and Outdoor Services and Bluestake to avoid shallow utilities and irrigation. The Contractor is responsible for all repairs required to return to area to original condition after fencing is removed, including, but not limited to, sod, asphalt and concrete repair.

Post holes in asphalt will be repaired using Fastpatch DPR Pourable Asphalt Repair. Using a hot or cold patch for the post holes is not allowed.

An 8' wide, two section chain-link access gate shall be required in the fence and the Facility Services' Project Manager and Construction Manager (as applicable) shall be given a key(s) to the gate lock by the Contractor for emergency access.

Fencing shall be placed immediately after or during site preparation, and remain in place for the entire duration of construction.

The staging plan shall note that the Contractor is to maintain the fence in a neat and orderly appearance.

01 56 39

Temporary Tree and Plant Protection

Existing trees and plants designated to remain shall be fenced off outside the drip line (this includes all memorial trees). "Snow" or "Cyclone" fencing shall be green; orange is prohibited. No construction activity shall occur within fenced area. Provide site maintenance and control of erosion, weeds, snow, debris, etc. Irrigation is not a standard part of the blue stake procedure. The contractor is responsible for coordinating with Owner (Landscape and Outdoor Services) to determine location prior to bid. The Contractor shall be responsible for relocating/repairing any irrigation equipment.

Owner is a Tree Campus USA designated school, and specific guidelines to follow

Section
Number

Title

are located at: <https://nau.edu/green-nau/tree-campus-usa/>

01 58 00 Project Identification

01 58 13 Temporary Project Signage

Free-standing or hanging signs for Contractors, Sub-contractors or suppliers are not allowed on University property. Site safety signage is allowed but must be approved by the NAU Project Manager.

01 58 16 Temporary Interior Signage

****END OF SECTION****

DIVISION 1 – GENERAL REQUIREMENTS

Section Number	Title
01 60 00	PRODUCT REQUIREMENTS
01 61 00	Common Product Requirements
01 61 13	Software Licensing Requirements
01 66 00	Product Storage and Handling Requirements Refer to Agreement for information regarding on-site and off-site storage.

****END OF SECTION****

Section Number	Title
01 70 00	EXECUTION AND CLOSEOUT REQUIREMENTS
01 73 00	Execution
01 73 29	<p>Cutting and Patching</p> <p>Cutting and patching of asphalt and concrete may necessitate removal of embedded utility survey markers. The Contractor is required to field verify marker locations prior to bidding and include replacement of markers where necessary. Refer to Division 33 for installation standards. Verification of marker location requires signoff on the FS#15 prior to substantial completion.</p>
01 74 00	Cleaning and Waste Management
01 74 13	<p>Progress Cleaning</p> <p>The Contractor shall maintain all work and staging areas in a clean and orderly condition to enhance the safety and appearance of the jobsite. Accumulations of refuse will not be permitted except as specifically approved in writing by the Owner.</p> <p>Contractor is responsible for removal of Bluestake markings and returning the site to its original condition.</p>
01 74 16	Site Maintenance
01 74 19	<p>Construction Waste Management and Disposal</p> <p>The Contractor will identify waste diversion opportunities and track waste and recycling figures for each of their respective projects. Waste and waste diversion totals should be tracked on a monthly basis and entered into the project-specific spreadsheet FS #49.</p> <p>The Contractor will provide proper and adequate trash containers at no additional cost to the Owner. These containers will be emptied at regular intervals so that trash will not be allowed to overflow and/or collect around the dump area.</p> <p>The placing of trash or debris in any Owner trash container by the Contractor or any subcontractor is expressly forbidden. Contractor shall be responsible for costs incurred by the Owner for the removal of trash placed in Owner trash containers.</p>
01 74 23	Final Cleaning

Section
Number

Title

Provide final cleaning of the Work prior to Owner occupancy. Final cleaning shall mean cleaning each surface or unit of work to conditions expected in a new building and high level maintenance program. Comply with manufacturer's instructions for cleaning operations. Cleaning shall include but not be limited to all of the following as applicable:

- Clean transparent/reflective surfaces to a polished, streak free condition including all mirrors, windows and door glass. Remove all paint, putty, labels or other vision obscuring materials. Replace any broken or damaged surfaces.
- Remove marks, stains, fingerprints, other soil and dirt from painted, decorated or stained work.
- Clean polish and/or wax woodwork as preferred by Owner.
- Clean light fixtures and lamps so as to function at full efficiency. Remove dirt, dust, fingerprints, excess lubrication, drywall, paint etc. and all non-permanent labels.
- Wipe clean all mechanical and electrical equipment; remove excess lubrication and other substances.
- Clean exposed interior and exterior surface finishes to condition free of dirt, dust, stains, films or other noticeable distracting substance.
- Clean exterior and interior metal surfaces, including doors and windows, of oil, stains, dust, dirt, paint and the like.
- Clean and polish all hard floors, remove dirt, material or water stains, scratches etc.; clean and vacuum all carpeted areas.
- Clean plumbing fixtures to polished, sanitary condition free of stains including those resulting from water exposure.
- Except as otherwise indicated or requested by Owner, remove all temporary protection devices and facilities which were installed during the course of the work.

Make building ready for occupancy in all respects. Protect cleaned areas until final inspection and acceptance.

All existing improvements inside or outside the property which have been disturbed, damaged or destroyed by the Work under the Contract shall be restored to the condition in which they originally were, including all storage and staging areas. Final inspection of storage / staging areas used during construction is required prior to final payment.

If the Contractor fails to clean up during, or at the completion of the Work, or fails to enforce such clean up by subcontractors, the Owner, subsequent to advising the Contractor in writing, may after five (5) working days proceed to perform clean-up of areas which pose a threat to life/safety or are excessively

Section Number	Title
	unsightly. The cost of cleaning provided by the Owner under this condition shall be borne by the Contractor, via deductive Change Order.
01 75 00	Starting and Adjusting
01 75 13	Checkout Procedures This information to be provided by the Design Professional.
01 75 16	Startup Procedures Signoff from the Owner (Utility Services department) on the FS #15 is required before any utility is energized. Refer to Division 33 for individual utility requirements. The Preliminary Balance Report shall have been submitted by the Contractor to the Owner prior to, and as a requirement of, Substantial Completion. The Final Balance Report shall have been submitted by the Contractor to the Owner prior to, and as a requirement of, Final Completion. Systems start-up, commissioning, and balancing shall be 100% complete prior to, and as a requirement of, Final Completion. Any additional information to be provided by the Design Professional.
01 77 00	Closeout Procedures
01 77 13	Preliminary Closeout Reviews The Contractor shall request the Owner to schedule a closeout meeting to be scheduled 30 days prior to substantial completion.
01 77 16	Final Closeout Review The Contractor will schedule a meeting with the Owner and DP when the all the document packages are ready for the individual substantial completion, final completion and final payment phases.
01 77 19	Closeout Requirements For all closeout requirements, please refer to the Construction Agreement located at http://nau.edu/Facility-Services/DP_Contract/ <i>All contracts are listed under "Contracts". Please refer to the appropriate contract's closeout requirements specific to the project you are contracted for.</i>

Section Number	Title
01 78 00	Closeout Submittals
01 78 23	Operation and Maintenance Data
01 78 23.13	<p>Operation Data</p> <p>Upon completion of the installation of all work specified in Construction Documents, and prior to Final Completion, Contractor shall furnish to the DP for review; one (1) complete bound copy and one (1) electronic copy of operating and maintenance instructions and parts lists for all material and equipment, including electrical and control items, being supplied. Upon receipt of review, the Contractor shall submit three (3) complete bound corrected copies and one (1) electronic corrected copy of the operating and maintenance instructions and parts list for all material and equipment in divisions 2-48. Operation and maintenance manuals for <u>all</u> specified equipment and systems shall be provided as part of the contractor’s base bid.</p>

Assemble Operation and Maintenance (O&M) Manuals in hard-back 3-ring loose leaf binders. Manuals will be organized by division will all warranties in a separate section at the back of the manual. Suitably label and index all material contained therein for ready reference.

Operating instructions shall include complete operating sequence, control diagrams, description of method of operating machinery, machine serial numbers, factory order numbers, parts lists, instruction books, suppliers’ phone numbers and addresses and individual equipment guarantee. Parts lists shall be complete in every respect, showing all parts and part numbers for ready reference.

O&M materials related to any of the following building components (as applicable for each project) are to be provided by the Contractor to the project manager to then be submitted to the Office of Regulatory Compliance:

- boilers
- emergency generators
- acid neutralization tanks
- grease interceptors
- sand/oil separators
- cooling towers
- chillers (documenting refrigerant type used)
- pre/post construction stormwater controls/NOI’s
- emergency showers
- bulk chemical storage locations
- fume hoods/bio-safety cabinets

Section Number	Title
	<ul style="list-style-type: none"> • location of sanitary sewer drains
01 78 23.16	<p>Maintenance Data</p> <p>Close-out submittals shall include a completed “Maintenance Check List” (FS#88) indicating all maintenance and frequency required for warranty purposes.</p>
01 78 29	<p>Final Site Survey</p> <p>At the completion of underground utilities and final site work, the Contractor shall provide an as-built drawing of all work completed. An as-built drawing for underground utilities shall be provided within 30 days of completion of utility work. The final site work drawing shall be provided after all site work is complete. The as built drawings shall consist of the following:</p> <ul style="list-style-type: none"> • Design Professional is to put as-builts in CAD format. • All buried and concealed items must be located with GPS coordinates. This includes tie-in locations, pipe alignments, change in direction, valves, manholes, utility crossings, and depth of utility. • The site survey shall also include site as built grades which have been surveyed and verified by a licensed surveyor. • The as-builts must be certified by a licensed surveyor who is currently registered in the State of Arizona certifying the drawing and GPS coordinates are accurate. Refer to Division 01 32 23.
01 78 36	<p>Warranties</p> <p><i>DP to provide project-specific information on guarantee submittals.</i></p> <p>The Contractor’s warranty shall commence on the date of Substantial Completion and remain in effect for two years. Prior to Final Completion the Contractor shall schedule a 1 year and 2 year warranty walkthrough with the Owner.</p> <p>All other warranties shall commence at Substantial Completion unless otherwise specified by manufacturer. These warranties are to remain in effect per the Construction Documents, including as specified throughout these Design Guidelines and Technical Standards.</p> <p>The Contractor shall provide 24-hour response to all critical building systems, i.e., loss of heating, cooling and control systems. If applicable, the Contractor shall provide at Substantial Completion, service agreements between service companies and the Owner for all critical areas. The service agreement shall include 24-hour phone numbers and contact persons’ names the Owner may use in case of emergency. The emergency service agreement shall remain in effect for the two-year warranty period. The Contractor shall provide a contact</p>

Section Number	Title
	<p>person’s name and phone number for Contractor’s bonding company for use if the Owner experiences problems during the warranty.</p> <p>All other, noncritical warranty items will be corrected within five (5) working days; unless the Contractor notifies the Owner in writing that a delay will be experienced due to shipping of materials. A shipping date must be provided to advise the Owner of the approximate date of warranty repair. All warranty work must commence as soon as reasonably possible and be diligently prosecuted to completion.</p>
01 78 39	<p>Project Record Documents For all project record documentation procedures, please reference the Construction Agreement located at http://nau.edu/Facility-Services/DP_Contract/</p> <p>Refer to Owner’s form FS #76 at http://nau.edu/Facility-Services/DP_Contract/ for example of As-Builts required.</p>
01 78 43	<p>Spare Parts <i>DP to provide project-specific information on guarantee submittals.</i></p>
01 78 46	<p>Extra Stock Materials Refer to Owner’s form FS #76 at: http://nau.edu/Facility-Services/Planning/Forms-Index/</p>
01 78 53	<p>Sustainable Design Closeout Documentation <i>DP to provide project-specific information.</i></p>
01 79 00	<p>Demonstration and Training Refer to Owner’s form FS #76 at: http://nau.edu/Facility-Services/DP_Contract/</p>

****END OF SECTION****

Section Number	Title
01 80 00	PERFORMANCE REQUIREMENTS Intentionally left blank.
01 81 00	Facility Performance Requirements
01 81 13	Sustainable Design Requirements The Owner's Project Manager will be designated as an alternate project administrator for all sustainable design programs.

****END OF SECTION****

Section Number	Title
01 90 00	LIFE CYCLE ACTIVITIES Intentionally left blank.
01 91 00	Commissioning
01 91 13	General Commissioning Requirements Commissioning Agent is typically hired directly by Owner. Commissioning Agent is shall adhere to ASHRAE Standards and Guidelines.
01 92 00	Facility Operation
01 92 13	Facility Operation Procedures <i>This section is to include project specific information which will be provided by the DP.</i>
01 93 00	Facility Maintenance
01 93 13	Facility Maintenance Procedures <i>This section is to include project specific information which will be provided by the DP.</i>

****END OF SECTION****

SectionTitle

Number

02 00 00 EXISTING CONDITIONS

02 22 00 Existing Conditions Assessment

02 30 00 SUBSURFACE INVESTIGATION

02 31 13 Seismic Investigations

02 32 13 Subsurface Investigation

02 40 00 DEMOLITION

02 50 00 SITE REMEDIATION

02 60 00 CONTAMINATED SITE MATERIAL REMOVAL

02 70 00 WATER REMEDIATION

02 80 00 FACILITY REMEDIATION

SectionTitle

Number

02 20 00 EXISTING CONDITIONS

02 22 00 Existing Conditions Assessment

Part 1 – General

This section applies to all activities that materially change or affect the current features found on campus. Areas incorporated into this section are civil surveys, geotechnical engineering investigation, archaeological studies and utility mapping.

Part 2 – Products

N/A

Part 3 – Execution

All existing built site features shall be noted as to their disposition during and after construction, i.e., removed, relocated, demolished, stored, etc. Contractor is to provide record photographs, prior to the start of construction, documenting the condition of all site features and areas to remain (i.e. parking lots, landscape areas, etc.).

All landscape material (trees, shrubs, etc.) and irrigation supply devices shall be noted as to remain, stored, relocated or demolished. If existing plant material is to remain or be stored for future project use, it shall be noted as the Contractor’s responsibility to maintain such plant material for the duration of construction.

Any existing site feature (built or plant material) shall be clearly identified as to whom will remove, relocate, demolish or store it (Contractor or NAU).

****END OF SECTION****

Section Title

Number

02 30 00 SUBSURFACE INVESTIGATION

02 31 13 Seismic Investigations

Part 1 – General

DP to insert seismic investigation report.

Part 2 – Products

N/A

Part 3 – Execution

N/A

02 32 13 Subsurface Investigation

Part 1 – General

- Any project requiring subsurface investigation work shall be coordinated through Owner.
- Blue stakes shall only occur when disturbance to the ground is expected within two weeks of the request.
- Soils investigations to determine subsurface conditions shall be made prior to the design and construction of new buildings and other structures. Such investigations shall also be conducted when additions to existing facilities are considered and are of such a scope that would significantly increase or change the distribution of foundation loads.
- Geotechnical investigations prepared for adjacent construction projects are another potential source of available site information.
- In accordance with the exception as prescribed in the International Building Code (IBC), where geotechnical data from adjacent areas are well known, the Owner’s building official (and along with a written request from the Design Professional) can accept the use of local engineering practices for the design of foundations.
- The Design Professional along with all other consultants (e.g. Geotechnical Engineer, Structural Engineer, Etc.) shall identify the type of tests, number of tests, frequency of tests, requirements of tests, etc....
- Where geotechnical investigations are required, a written report of the investigations shall be submitted at the time of schematic design and no later than permit application.
- In any event, geotechnical investigations shall be conducted and reported in accordance with (and fully comply with) the applicable requirements as specified in the most recent edition of the Owner’s adopted International Building Code (IBC).

Part 2 – Products

Such work shall be performed by an independent testing agency. An approved agency shall provide all information as necessary for the NAU Project Manager, Design

Section Title
Number

Professional, and NAU Building Official to determine that the agency meets the applicable requirements as specified in the International Building Code. An approved agency shall be objective, competent and independent from the contractor responsible for the work being inspected. The agency shall also disclose possible conflicts of interest so that objectivity can be confirmed. An approved agency shall have adequate equipment to perform required tests. The equipment shall be periodically calibrated. An approved agency shall employ experienced personnel educated in conducting, supervising and evaluating tests and/or inspections.

As part of the basis for approval of a particular inspection agency, the agency must demonstrate its objectivity and competence. The judgement of objectivity is linked to the financial and fiduciary independence of the agency. The competence of the agency is judged by its experience and organization, and the experience of its personnel. For example, suppose that ACME Agency is the inspection agency employed by Builder’s, Inc. for factory-built fireplaces. During an investigation of the agency, it is discovered that ACME and Builder’s are subsidiaries of the same parent company, Conglomerate, Inc. The inspection agency and manufacturer clearly have a relationship that is undesirable from the standpoint of independence.

Part 3 – Execution

Geotechnical Investigations Required

The purpose of a geotechnical investigation is to determine the engineering qualities of the subsurface such as soils or rocks at a site, and how their location and depth affects an envisioned construction project. The presence of any buried organic materials with poor engineering qualities, obstructions to earthwork, and the depth of the water table are also important to identify during a geotechnical investigation. Geotechnical investigations shall be conducted in accordance with applicable requirements as specified in the most recent edition of the Owner’s adopted International Building Code (IBC). The investigation of soils is to be done by a *registered design professional* in recognition that the testing and calculations necessitate individuals with significant experience in soil and foundation analysis. Where subsurface conditions are found or suspected to be of a critical nature, the Design Professional shall seek the professional advice of highly experienced foundation engineers.

Soils investigations to determine subsurface conditions shall be made prior to the design and construction of new buildings and other structures. Such investigations shall also be conducted when additions to existing facilities are considered and are of such a scope that would significantly increase or change the distribution of foundation loads.

Geotechnical Investigations Exception

The Owner’s Building Official (and along with a written request from the Design Professional) shall be permitted to waive the requirement for a geotechnical investigation

SectionTitle
Number

where satisfactory data from adjacent areas is available that demonstrates an investigation is not necessary for any of the conditions as noted in the applicable code sections of the IBC (e.g. Sections 1803.5.1 through 1803.5.6 and Sections 1803.5.10 and 1803.5.11.)

Regardless of the objective of the soils investigation, the information generally required includes one or more (or all) of the following items for determining subsurface conditions:

1. The depth, thickness and composition of each soil stratum;
2. For rock, the characteristics of the rock stratum (or strata), including the thickness of the rock to a reasonable depth;
3. The depth of ground water below the site surface; and
4. The engineering properties of the soil and rock strata that are pertinent for the proper design and performance of the foundation system.

For shallow foundations, the soils investigation should yield sufficient information to establish the character and load-bearing capacity of the soil (or rock) at depths that will receive the foundations.

Foundation problems are not uncommon and may vary greatly, ranging from very simple and manageable problems to very complex situations that may be either manageable or without practical remedy.

As indicated in the IBC exception, where geotechnical data from adjacent areas are well known, the building official (and along with a written request from the Design Professional in responsible charge of the project) can accept the use of local engineering practices for the design of foundations.

Information to be included in Construction Documents

When a written report is required by the International Building Code, it is required to include at a minimum the items listed in the applicable code sections. Load-bearing values for soils must be documented so that the foundation design can be verified.

Also show all: existing conduits, drains, utility lines, sewers, tunnels, cables, trees, paving, walks, foundations and other objects or obstructions, whether in use or abandoned. State that information is for contractor’s use and that in no way shall the Owner be held responsible for accuracy of the information.

Preparation of Plans for Borings

In the preparation of plans for boring locations, the Design Professional shall study plans of existing underground utilities and shall locate borings to avoid these utilities. Where excavation will remove lateral support from any foundation, an investigation shall be conducted to assess the potential consequences and address mitigation measures. Maps

SectionTitle

Number

showing underground installations may be available for review upon request from Facility Services.

Unless approved by Owner, the disturbance from a subsurface investigation shall be remediated to restore it to original condition, immediately after a survey is complete. Owner may withhold payment until this is corrected.

****END OF SECTION****

SectionTitle

Number

02 40 00 DEMOLITION

Part 1 - General

A demolition plan shall be created to graphically show the extent of the demolition work and its impact to adjacent areas. Adequate provisions must be made to maintain traffic (vehicles, bikes and pedestrians) through/past the construction zone via the use of temporary walkways, signage, barricades, etc. Emergency egress paths are particularly critical, so closure of existing building exits and egress paths must be coordinated with the Owner (Fire Marshal). Develop traffic control plans for vehicles, bikes and pedestrians in advance for Owner review/approval. Owner may from time to time choose to assist with minor signage, but the bulk of the traffic control measures during construction lies with the contractor.

Provisions shall be made in the documents to require that all demolition work be performed without disruption to adjacent occupied areas, i.e., off-hours work. Only when the anticipated demolition work will not present disruption to the user or occupant can the assumption be made that it can be conducted at any time.

Demolition work is usually associated with trash and dust. Appropriate provisions shall therefore be made to address mitigation procedures in the demolition work.

The demolition plan shall identify all materials/equipment, etc., which are to be reused and/or salvaged by either the Owner or the Contractor. Please keep in mind that all equipment and building material is the property of Owner and only the Owner can make the determination on reuse and salvage.

A complete investigation of the area(s) shall be performed so that all existing aspects and elements affected by the project are either removed under the demolition plan or incorporated into the new work with the installation drawings, i.e., existing/abandoned outlets, t-stats, etc. Where callouts such as 'Match Existing' are used, these locations shall be field checked during design to verify that the proposed improvement will indeed fit well to the existing.

Part 1 – General

Other than items which are to be reused on the project, there are two groups of salvageable material presented with nearly all projects. Care must be exercised when handling all salvageable material so as to maintain its value.

The following items are may be salvaged by the Owner and Contractor must consult Owner before disposition of these items.

- LED exit lights
- Door Hardware
- Fire Alarm Exits

SectionTitle
Number

- Chalk/White boards
- Drinking Fountains
- EMCS Equipment
- Window Blinds
- Lab Fixtures
- Meters (all kinds)
- Backflow Preventers
- Furniture and non-permanent fixtures
- Artwork
- Wood/HM Doors
- Plumbing Fixtures
- Electrical Light Fixtures
- Electrical panels
- Casework
- Electrical Equipment
- Mechanical Equipment
- Disconnect switches
- Starters
- Ceiling diffusers
- Elevator equipment
- Windows
- Projection screens
- Soap dispensers
- Transformers
- Mirrors
- Clocks
- Thermostats
- Irrigation equipment
- Access doors
- Shelving
- Refrigeration equipment
- Landscape planting
- HVAC mixing boxes
- Lab equipment (hoods)

Prior to finalizing the construction documents the DP shall conduct a site meeting with the appropriate Owner personnel and determine precisely what items are to be salvaged. The documents should then clearly identify what is to be salvaged, by whom and where it is to be delivered to or stored. Options include but are not limited to:

- Removal and transport by Contractor.
- Removal by Contractor and transport by Owner.

SectionTitle
Number

- Removal and transport by Owner.

Whenever Owner is to participate in either the removal or transportation of salvage materials a time frame and contact person shall be identified and referenced in the documents.

All items encountered which contain an affixed Northern Arizona University Control Tag (has a property control number) require special procedures for disposal. Consequently, these items should be brought to the attention of the Owner (Project Manager). Items which contain this tag are part of the registered inventory of Owner and disposal must be coordinated through Owner’s Property Administration department.

Fluorescent light fixture tubes and certain light fixture ballasts must be separately disposed of in accordance with applicable environmental regulations. Consequently, the removal and disposal of existing fluorescent light fixtures shall include the following:

- All fluorescent tubes shall be removed and packaged by the Contractor in cartons. The number of tubes in each carton shall be clearly marked on the outside of the carton. Contractor to deliver packaged tubes to Owner’s universal wastes table, via coordination with the Owner’s Moving and Recycling Services department.
- Fixture ballasts not clearly marked as containing “NO PCB’s” shall be removed by the Contractor and after short clipping all wires place them in a metal drum. After completion of the demolition effort, Owner will remove the drum for disposal offsite. Apportioned disposal costs are then to be charged to the project.

Part 2 – Products

N/A

Part 3 – Execution

All electrical services discontinued with the demolition effort shall be properly “tagged out”.

Prior to starting any demolition work, Contractor shall verify with Owner (Project Manager and Trades) that all utilities have been disconnected.

In the case of a building renovation, some of the utilities might need to stay on during the renovation work, to keep the building under a conditioned environment (i.e. heating system stays on during a winter interior renovation project). Close coordination with the Owner (Project Manager and Trades) will then be required to ensure safe work environment during renovation. Contractor shall also coordinate with Owner’s Fire Marshal and, as applicable depending on the nature of the renovation work, shall present a plan identifying how the building’s Fire Life Safety systems will remain active and protect the building against fire during the renovation process.

SectionTitle
Number

In the case of the demolition of street lighting and pedestrian lighting, there should never be a time when travelways for vehicles, bikes and pedestrians experience a substandard level of lighting. This may be special sequencing of the demolition work to keep the existing lights in place until the new lighting is operational, or the provision for temporary lighting, or some other means to maintain safe lighting levels.

All permits and fees for demolition are the responsibility of the Contractor but these requirements should be specifically identified in the contract documents.

****END OF SECTION****

SectionTitle

Number

02 50 00 SITE REMEDIATION

Part 1 – General

Through the Owner’s Office of Environmental Health and Safety, Owner will provide some information on potential existing site conditions that might require site remediation. This could also be discovered during subsurface investigations. Depending on the nature of the required remediation, Owner may elect to either hire an independent contractor to conduct the remediation effort, or have the DP and Contractor identify the nature of the remediation and hire some experts appropriately.

If during the course of construction, some unknown conditions are discovered by the Contractor, they should be reported immediately to Owner’s Project Manager who will take the appropriate measure, including contacting the Owner’s Office of Environmental Health and Safety.

Part 2 – Products

N/A

Part 3 – Execution

N/A

****END OF SECTION****

SectionTitle

Number

02 60 00 CONTAMINATED SITE MATERIAL REMOVAL

Part 1 – General

Should the Contractor encounter contaminated site materials during earthwork activities, Contractor shall stop all work and report immediately to Owner (Project Manager). Depending on the nature of the contamination, Owner will make the determination to either contract the Contractor to remove all contaminated materials, or hire an independent contractor to perform such task.

Part 2 – Products

N/A

Part 3 – Execution

N/A

****END OF SECTION****

SectionTitle

Number

02 70 00 WATER REMEDIATION

Part 1 – General

The Design Professional and Contractor shall review the geotechnical and/or soil investigation report(s) and determine if water might be an issue during excavation activities. If such, Design Professional shall provide recommendations on how to perform water remediation and include in the design ways to divert the water, collect it, or deal with it with appropriate choice of foundation system.

The NAU Flagstaff campus has numerous sporadic groundwater springs that may not always been found during subsurface investigations, especially depending on the time of the year the investigation is being performed. Numerous springs have developed unpredictably within caissons or footings during excavation, requiring water pumping, or switching to a different type of concrete mix design or foundation system to adjust to soil conditions.

Contractor shall be aware of this risk and be prepared to take appropriate measures should water remediation be necessary on the project.

Part 2 – Products

N/A

Part 3 – Execution

N/A

****END OF SECTION****

SectionTitle

Number

02 80 00 FACILITY REMEDIATION

Part 1 – General

As part of the existing conditions investigation to be performed during the Programming phase of the project, Owner will conduct and provide a survey report on potential existing hazardous materials (such as Asbestos, Lead, Radioactive materials, hazardous chemicals, etc...) to the Design Professional and Contractor at the end of the Programming Phase.

As the project design evolves and scope is being defined more precisely, the DP shall identify existing building components that will need to be demolished or disturbed during the renovation process and provide a detailed demolition scope that will help the Owner define further the level of facility remediation required for the project. The Owner’s Office of Environmental Health and Safety shall be informed of all changes of scope throughout the project with adequate lead time to ensure that any additional necessary remediation is accounted for and completed prior to the commencement or continuance of work in the target area.

On almost all renovation projects, Owner will handle the facility remediation scope, hiring an independent contractor to perform the work. All required remediation work shall be scheduled and performed prior to the commencement of other demolition or construction activities. Remediation of all hazards may require removal of materials which are not otherwise impacted by the project if contact or disturbance hazards to workers exist or may arise during the project. Owner will make recommendations for abatement scope based on their evaluation of the demolition scope, building area, applicable regulations, and NAU standards and policies.

Refer to Section Division 1 for additional procedural information.

Part 2 – Products

N/A

Part 3 – Execution

N/A

****END OF SECTION****

SectionTitle

Number

- 03 00 00 CONCRETE**
- 03 10 00 CONCRETE FORMING AND ACCESSORIES**
- 03 11 00 Concrete Forming**
- 03 11 13 Structural Cast-in-Place Concrete Forming
- 03 11 16 Architectural Cast-in-Place Concrete Forming
- 03 15 00 Concrete Accessories**

- 03 20 00 CONCRETE REINFORCING**
- 03 21 00 Reinforcing Steel**
- 03 22 00 Welded Wire Fabric Reinforcing**
- 03 24 00 Fibrous Reinforcing**

- 03 30 00 CAST-IN-PLACE CONCRETE**
- 03 31 00 Structural Concrete**
- 03 34 00 Low Density Concrete**
- 03 35 00 Concrete Finishing**
- 03 39 00 Concrete Curing**

- 03 40 00 PRECAST CONCRETE**
- 03 41 00 Precast Structural Concrete**
- 03 45 00 Precast Architectural Concrete**
- 03 48 00 Precast Concrete Specialties**

- 03 50 00 CAST DECKS AND UNDERLAYMENT**
- 03 52 16 Lightweight Insulating Concrete

- 03 60 00 GROUTING**
- 03 63 00 Epoxy Grouting**

- 03 80 00 CONCRETE CUTTING AND BORING**
- 03 81 00 Concrete Cutting**

Section Title

Number

03 00 00 CONCRETE

ALL CONCRETE HARDSCAPE & RELATED SITE CONCRETE MUST ADHERE TO THE 2015 LANDSCAPE MASTER PLAN AS WELL AS THE DIVISION 3 TECHNICAL STANDARDS. THE LANDSCAPE MASTER PLAN CAN BE FOUND BY FOLLOWING THE LINK PROVIDED BELOW. NOTE THAT THE EXISTING DIVISION 3 TECHNICAL STANDARDS INCLUDED IN THIS DOCUMENT ARE STILL APPLICABLE FOR ALL OTHER FORMS OF CONCRETE AS WELL AS THE TYPICAL STANDARDS NOT ADDRESSED IN THE LANDSCAPE MASTER PLAN. ALL NEW CONCRETE SITE WORK MUST CONFORM TO THE LANDSCAPE MASTER PLAN & THESE TECHNICAL STANDARDS UNLESS WRITTEN EXCEPTION IS MADE BY THE OWNER. IT IS THE CONTRACTORS' AND DESIGN PROFESSIONALS' RESPONSIBILITY TO IDENTIFY IN WRITING TO THE OWNER ANY DISCREPANCIES IDENTIFIED BETWEEN THESE TWO DOCUMENTS THAT MAY ALTER A PROPOSAL OR BID.

2015 LANDSCAPE MASTER PLAN LINK:

http://nau.edu/uploadedFiles/Administrative/Finance_and_Administration/Facility_Services/Documents/DP_Contract/2015%20Landscape%20Masterplan%20Final.pdf

All concrete work shall conform to the code requirement in Section 01 41 00 and American Concrete Institute (ACI) Standards 301 (Specifications for Structural Concrete), 305 (Hot Weather Concreting), 306 (Cold Weather Concreting), 308 (Recommended Practices for Curing Concrete) & 318 (Building Code Requirements for Structural Concrete). Any non-conforming work shall be removed and replaced at the contractor's expense.

Inspections required per Section 01 41 00.

Specify both cold and hot weather requirements for mix, placement, and curing of concrete.

All concrete foundation walls require waterproofing. The DP shall specify the methods and products that may be used for this purpose. Foundation wall waterproofing must be backfilled within 3 days. Inspection required prior to backfill.

Concrete civil work design shall conform to the details set forth in the City of Flagstaff Engineering Design and Construction Standards and Specifications.

Concrete curb cuts, ramps etc. to allow for handicapped accessibility shall meet the requirements outlined in Section 01 41 00.

SectionTitle
Number

Supplementary Cementitious materials

Fly ash may be added to concrete as a supplementary cementitious material with explicit approval of the Owner. If fly ash is required as part of the mix design, maturity modeling of the mix during curing is required.

****END OF SECTION****

Section Title

Number

03 10 00 CONCRETE FORMING AND ACCESSORIES**03 11 00 Concrete Forming**Part 1 – General

The concrete contractor shall supply all formwork complete with necessary shoring, bracing and anchorage.

Earth forms are permitted in the forming of appropriate subgrade elements. Sides of earth forms shall be hand trimmed and bottoms swept clean of all loose dirt prior to placement of concrete. No concrete shall be placed in earth forms prior to review and inspection by the DP and the Owner's project manager.

Part 2 – Products

N/A

Part 3 – Execution

The proper concrete hydration reaction is particularly sensitive to cold temperatures when using earth forms. The following standards shall be in place for cold weather concrete placement in addition to the ACI 306 guidelines for Cold Weather Concreting as referenced by Maricopa Association of Governments Specifications and Details for Public Works Construction (MAG).

All temperatures referenced under cold weather concrete are to be taken in the shade and away from artificial heat sources. Temperatures shall be collected and recorded in Fahrenheit degrees.

In cases with ambient temperature concrete, concrete placement operations shall not be continued when a descending air temperature falls below 40 degrees F; nor shall concrete placement operations be resumed until an ascending air temperature reaches 35 degrees F. Mixing and placing concrete shall continue no later in any day than that time which will allow sufficient time to place, finish and protect the concrete already placed before the air temperature drops to 35 degrees F.

When using heated concrete mixes, concrete operations may be allowed with specific DP and Owner's Project Manager approval, although the air temperature in the shade and away from artificial heat is below the limit permitted above. Where concrete operations are thus allowed, the contractor shall use equipment to heat the aggregates or water or both, prior to mixing. Aggregates shall be uniformly heated to at least 60 degrees F. and shall have no chunks of ice. Equipment used to heat the aggregates shall be such that uniform temperatures are obtained throughout the aggregate within each batch and from one batch to another. Water shall not be heated in excess of 150 degrees F.

Section Title
Number

The contractor shall provide adequate insulation or heat or both, to protect the concrete after placement. This protection shall be to the extent required to maintain a temperature under the insulation of the concrete of from 60 to 90 degrees F. for a period of 72 hours after placement and from 40 to 90 degrees F. for an additional 96 hours.

Regardless of the air temperature at the time of mixing and placing concrete, the protection specified above shall be provided at all times when the air temperature is below 35 degrees F.

Forms shall remain in place throughout any required curing period. All portions or pieces of any wood forms shall be removed completely after the cure period has been completed and prior to Owner possession.

03 11 13 Structural Cast-in-Place Concrete Forming

Part 1 – General

All Structural Cast-in-Place Concrete Forming shall be in accordance with MAG2010 standard Section 505.3: Forms for Concrete Structures

Forms shall be of suitable material and of type, size, shape, quality, and strength to enable construction as designed. The forms shall be true to line and grade, mortar tight, and sufficiently rigid to resist any appreciable amount of springing out of shape during placing of the concrete. The responsibility for their adequacy shall rest with the Contractor. All dirt, chips, sawdust, nails, and other foreign matter shall be completely removed from forms before any concrete is deposited. The surfaces of forms shall be smooth and free from irregularities, dents, sags and holes that would appreciably deface the finished surface. Forms previously used shall be thoroughly cleaned of all dirt, mortar and foreign matter before being reused, and the reuse of forms shall be subject to the approval of the Design Professional. Before concrete is placed in forms, all inside surfaces of the forms shall be thoroughly treated with an approved releasing agent that will leave no objectionable film on the surface of the forms that can be absorbed by the concrete. Care shall be exercised that no releasing agent is deposited on previously placed concrete. (MAG2010, p 505-4).

Waterproofing will be applied to foundation walls after removal of the forms but prior to backfilling the excavation. Foundation wall waterproofing must be backfilled within 3 days. Inspection is required prior to backfill. Refer to Division 1 for inspection guidelines.

Part 2 – Products

SectionTitle
Number

N/A

Part 3 – Execution

N/A

03 11 16 Architectural Cast-in-Place Concrete Forming

Part 1 – General

N/A

Part 2 – Products

At a minimum all form materials shall be in accordance with MAG2010 standard Section 505.3: Forms for Concrete Structures. Form materials, metal or wood shall be specified with requirements listed below:

Exposed concrete - use HDO plyform

Unexposed concrete – use A-C plywood

DP will specify the grade and thickness of plywood form material. Plans and specs will limit reuse to 3 times.

Part 3 – Execution

N/A

03 15 00 Concrete Accessories

Part 1 – General

All anchors and inserts in exterior work exposed to weather shall be inset and/or protected to prevent rusting. The concrete cover for anchors and inserts must meet the minimum concrete cover requirements per ACI 318.

Part 2 – Products

N/A

Part 3 – Execution

N/A

****END OF SECTION****

Section Title

Number

03 20 00 CONCRETE REINFORCING**03 21 00 Reinforcing Steel**Part 1 – General

All reinforcement shall be in conformance with MAG 2010 Section 727: Steel Reinforcement. All placement of reinforcement shall be in accordance with Section 505.5 Placing reinforcement.

Reinforcing steel shall be a minimum of 60 ksi yield grade, deformed. Exceptions to this shall require DP approval.

All sidewalks shall have, placed to reinforce the slab at midpoint, steel welded wire mesh with 6 in x 6 in openings.

Exterior facilities that are exposed to weather that may be subjected to deicing during the winter including but not limited to: stairs, walks, ramps, curbs and loading docks, shall have all reinforcing steel and accessories epoxy coated per ASTM A775.

Concrete features that house interior corrosive environments such as chemical storage rooms and swimming pool buildings shall have all reinforcing steel and accessories epoxy coated per ASTM A775.

Other reinforcement may be uncoated per MAG2010 section 727.

Part 2 – Products

N/A

Part 3 – Execution

N/A

03 22 00 Welded Wire Fabric ReinforcingPart 1 – General

N/A

Part 2 – Products

N/A

Part 3 – Execution

Welded wire fabric shall be held firmly in place and spliced not less than 2 meshes per MAG 505.5.3.

SectionTitle

Number

03 24 00 Fibrous Reinforcing

Part 1 – General

Fiber mesh reinforcement is an allowable substitute for wire mesh with DP written approval.

Part 2 – Products

N/A

Part 3 – Execution

N/A

****END OF SECTION****

Section Title

Number

03 30 00 CAST-IN-PLACE CONCRETEPart 1 – General

All cast-in-place concrete shall conform to the MAG 2010 for portland cement concrete (PCC). PCC shall be composed of cementitious materials, fine and coarse aggregates, water, and, if specified or allowed, certain chemical admixtures and additives in conformance to MAG 2010 Section 725.

Only the following classes of concrete will be considered acceptable for construction at Northern Arizona University: Class AA and Class A in conformance to MAG 2010 Section 725.

All exterior concrete shall conform to the specifications for Class AA concrete with 5% to 7% air entrainment (containing at a minimum: 600 pounds per cubic yard of cementitious materials and having a minimum compressive strength of 4000 psi at 28 days).

Upon the recommendation and specification of a DP, all interior concrete shall conform to the specifications for Class A concrete (containing at a minimum: 520 pounds per cubic yard of cementitious materials and having a minimum compressive strength of 3000 psi at 28 days).

PCC Street pavement shall conform to MAG 2010 Section 324.

Part 2 – Products

N/A

Part 3 – Execution

N/A

03 31 00 Structural concretePart 1 – General

All structural concrete shall conform to MAG 2010 for portland cement concrete (PCC). PCC shall be composed of cementitious materials, fine and coarse aggregates, water, and, if specified or allowed, certain chemical admixtures and additives in conformance to MAG 2010 Section 725.

Only the following classes of concrete will be considered acceptable for construction at Northern Arizona University: All exterior concrete shall conform to the specifications for Class AA concrete containing 5% to 7% air entrainment (containing at a minimum: 600 pounds per cubic yard of cementitious materials and having a minimum compressive strength of 4000 psi at 28 days). Upon the recommendation and specification of a DP, all interior concrete shall conform to the specifications for Class A concrete (containing at a minimum: 520 pounds per cubic yard of

Section Title
Number

cementitious materials and having a minimum compressive strength of 3000 psi at 28 days).

No structural concrete shall be placed without the approval of the FS project manager or the special inspector representing the FS project manager.

Part 2 – Products

N/A

Part 3 – Execution

N/A

03 34 00 Low Density Concrete

Part 1 – General

Lightweight concrete shall not exceed 110 pounds per cubic foot and shall be made from lightweight coarse aggregates and a blend of lightweight and normal weight fines.

Part 2 – Products

N/A

Part 3 – Execution

N/A

03 35 00 Concrete Finishing

Part 1 – General

In general, exterior concrete traffic surfaces shall be designed with a heavy broom finish.

All stoops, porches, steps and any other exterior concrete shall be finished so as to slope to drain and shall be placed per the plans within the dimensional tolerances for concrete slabs (+¼ to -¼ inches). Ponding or puddling resulting from finish work that does not address this requirement shall be repaired at the Contractor's expense.

Concrete Finished Floors

Generally concrete finished floors are to receive a hardener with colorant. Positive protection shall be provided to prevent staining and chipping during construction work. DP to specify products finish required and positive protection required.

All slabs with floor drains shall be required to slope to floor drains with no ponding areas, and be dished ½ inch deep around all floor drains.

Section Title
Number

A suitable sealant or paint shall be specified for interior exposed concrete.

Part 2 – Products

N/A

Part 3 – Execution

N/A

03 39 00 Concrete Curing

Part 1 – General

All concrete must be cured in accordance with MAG2010 Section 505.8. DP must specify the methods or materials necessary for proper curing of concrete structural elements. Examples include water fog, chemical membrane, wet burlap, or cold weather blanket protection. DP should include the weather conditions wind, hot or cold temperatures that may trigger special curing methods as applicable to structural features. The Contractor is solely responsible for protection of all concrete products throughout the curing period. Any damage to partially cured concrete shall require removal and replacement at no cost to Owner.

Non-structural concrete must be cured a minimum of three days prior to form removal. Normal concrete in structures and pavement shall be cured a minimum of seven days.

On all formed structural concrete, forms shall remain in place until work has reached 90% of its design strength or as specified by Structural Engineer of record.

High strength concrete and concrete that includes supplemental cementitious materials such as fly ash may require extended curing and weather protection. DP shall provide guidelines and requirements for curing protection and if appropriate, maturity modeling methods and procedures for concrete.

Part 2 – Products

N/A

Part 3 – Execution

N/A

****END OF SECTION****

Section Title
Number

03 40 00 PRECAST CONCRETE

This work shall consist of furnishing and placing precast prestressed concrete members in accordance with the details shown on the plans, and as provided in the MAG 2010 specifications and special provisions.

All precast concrete that is part of an exterior feature or element that will be exposed to the weather, shall be formed with Class AA PCC with five to seven percent air entrainment.

03 41 00 Precast Structural Concrete

Part 1 – General

Projects designed with precast, tilt-up, or special finished concrete shall include in the Project Specifications a requirement for a sample panel, constructed as specified. The panel shall be a minimum of 36 square feet. It shall be erected at, and remain on the jobsite as the visual criterion which the final product must match.

Part 2 – Products

N/A

Part 3 – Execution

N/A

03 45 00 Precast Architectural Concrete

Part 1 – General

This section applies to areas of a building that the DP may be considering for the use of precast panels, or special design features or projection from and around the building that will be visible.

As noted above, projects incorporating architectural precast concrete shall have included in the specifications a requirement for a sample. Such sample shall be made at the site and remain on site as a visual criterion through project completion.

The manufacturer of precast pre-stressed concrete shall submit structural calculations, certified by an Arizona registered Engineer, to the DP for approval.

As part of design proposal and approval process, colors, finishes and scoring of materials shall be presented to the facility owner and each selection shall be clearly delineated either by a sample or a drawing of a scale that can be viewed across a conference room. Elevations that contain precast material or features shall be keyed to such a sample or drawing.

SectionTitle
Number

Precast in-fill panels, elements or exposed precast structural members shall be designed and detailed in a manner that clearly and concisely conveys the architectural meaning and significance of its use.

Rough or heavy textured precast should be avoided immediately adjacent to heavy pedestrian traffic flow, or in the interior of the building (particularly corridors).

Precast concrete panels shall be water sealed with products warranted for a minimum of five years against UV breakdown.

Exposed panel fastening devices should be avoided due to annual maintenance costs (paint and rust inhibitors) and eventual staining of the panel.

Special consideration should be given to panel joinery and caulking when panels are intended to act as weather tight assemblies. The design of such joinery must facilitate required amounts of expansion/contraction and facilitate a neat appearance and weather tightness of the caulk joint.

Part 2 – Products

N/A

Part 3 – Execution

N/A

03 48 00 Precast Concrete Specialties

Part 1 – General

Precast concrete specialties that will be exposed to weather or corrosive environments (sewer lines, manholes, etc...) shall be made from Class AA PCC that conforms to MAG 2010 Section 725 five to seven percent entrained air.

Part 2 – Products

N/A

Part 3 – Execution

N/A

****END OF SECTION****

SectionTitle

Number

03 50 00 CAST DECKS AND UNDERLAYMENT

03 52 16 Lightweight Insulating Concrete

Part 1 – General

Lightweight concrete insulating fill roof decks shall not be used in conjunction with urethane roof systems. Lightweight structural concrete shall not be allowed.

Part 2 – Products

N/A

Part 3 – Execution

N/A

****END OF SECTION****

SectionTitle

Number

03 60 00 GROUTING

Grouting of concrete structures shall be in accordance with MAG 2010 Section 505.

03 63 00 Epoxy Grouting

Part 1 – General

Use of epoxy grout is not encouraged. However, it may be used as a retrofit or repair material upon approval by the Design Professional.

Part 2 – Products

N/A

Part 3 – Execution

N/A

****END OF SECTION****

SectionTitle
Number

03 80 00 CONCRETE CUTTING AND BORING

03 81 00 Concrete Cutting

Part 1 – General

N/A

Part 2 – Products

N/A

Part 3 – Execution

Control joints shall be tooled or cut into in slabs on grade so that the length to width ratio of each cut portion of the slab is no more than 1.25 to 1. Control joints shall be completed within 12 hours or optimal time of concrete placement per ACI specs. Control joint depth shall be $\frac{1}{4}$ the thickness of the slab whether tooled or cut.

****END OF SECTION****

SectionTitle

Number

04 00 00 MASONRY

04 01 00 Maintenance of Masonry

04 01 20 Maintenance of Masonry

04 05 13 Masonry Mortaring

04 05 23 Masonry Accessories

04 20 00 UNIT MASONRY

04 21 00 Clay Unit and Brick Veneer

04 22 00 CONCRETE UNIT MASONRY

04 23 00 GLASS UNIT MASONRY

04 40 00 STONE ASSEMBLIES

04 42 00 Exterior Stone Cladding

04 43 00 Stone Masonry

Section Title

Number

04 00 00 MASONRYPart 1 – GeneralSample Panels/ Mock up Walls

For all new and infill masonry work adjacent to existing walls, a 36 square foot sample wall (mock up) is required to be constructed on site near the proposed work area to evaluate the selected brick and the cured mortar colors for matching. Allow for a minimum of 3 weeks curing time to elapse prior to evaluation of the mortar color.

On new construction, a minimum 36 square foot sample wall (mock up) is required to establish the standard of acceptance for all elements of the work, including but not limited to: window and door frame installation details, mortar color, flashing, coursing, pattern, control joints, tie-in with other materials and finishes, accessories, etc. This sample wall is required for all masonry work whether brick, CMU or stone is proposed. The sample panel shall be approved by Owner and the Design Professional prior to ordering materials and commencement of masonry work. Allow for a minimum of 3 weeks curing time to elapse prior to evaluation of the mortar color.

Cold Weather Masonry

Masonry work shall conform to the latest revision to the following standards for cold weather masonry work: *Building Code Requirements for Masonry Structures* (ACI 530.1 /ASCE 6/ TMS 602).

These standards list the preparation, installation and protection procedures necessary when constructing masonry in cold weather.

1. Specification for Masonry Structures (ACI 530.1/ASCE 6/TMS 602)
2. Cold Weather Masonry Construction, PCA IS248
3. Hot and Cold Weather Masonry Construction, PCA LT232 (published by the Masonry Industry Council)

In general, when the ambient temperature is less than forty degrees F. masonry work shall not be constructed without heat, heated materials, and/or protection.

Hot Weather Masonry

Masonry work shall conform to the following standards for hot weather construction *Building Code Requirements for Masonry Structures* (ACI 530/ASCE 5/TMS 402). In general, this means that when the ambient temperature is greater than 100 degrees F (or 90 degrees F with 8 mph wind), masonry work shall not be constructed without

Section Title
Number

consideration for cooling masonry, controlling moisture uptake from units, and providing moist curing as well as necessary mortar protection.

In all cases with masonry work, the low humidity typical of the mountain campus environment leads to masonry units with high suction rates. Masons should test for and adjust the moisture of masonry units by wetting them to compensate for low humidity and high suction rates. The amount of wetting will depend on the rate of absorption of the brick at the time of installment. When being laid, the brick shall have suction sufficient to hold the mortar and to pull the excess water from the mortar, and shall be sufficiently damp so that the mortar will remain plastic enough to permit the brick to be leveled and plumbed after being laid without breaking the mortar bond.

The type of mortar joint should be specified. Tooled joints are required. Raked and weathered joints (or any joints which leave an exposed horizontal masonry unit edge at the joint) are not permitted for exterior masonry.

Controlling efflorescence

Design Professional should design to prevent efflorescence and include construction specifications for moisture protection during construction for all masonry. Designs shall prevent moisture from entering finished masonry walls with flashing and avoid unprotected horizontal sills. Designs shall seal out moisture, and every feature should drain or dry without absorbing moisture. Design wall systems with appropriate measures to prevent moisture transfer from building interiors. Include initial cleaning of masonry by the mason or contractor after first winter after building acceptance in contract specifications.

The tops of all exposed masonry walls shall receive a watertight cap or coping, i.e., sheet metal or precast concrete, to prohibit moisture infiltration and efflorescence.

Part 2 – Products

N/A

Part 3 - Execution

Masonry work that does not conform to the following tolerances shall be repaired or replaced. Tolerances are based on ACTUAL DIMENSIONS.

- Variations from plumb.
- In lines or surfaces of columns, walls, and arises: in 10 feet - $\frac{1}{4}$ "; in any story or 20 feet maximum - $\frac{3}{8}$ "; in four stories or more - $\frac{1}{2}$ ".

Section Title
Number

- For external corners, control joints and other conspicuous lines: in any story or 20 feet maximum - $\frac{1}{4}$ " ; in 40 feet or more - $\frac{1}{2}$ ".
- Variations from the level or the grades indicated on the drawings:
- For exposed lintels, sills, parapets, horizontal grooves and other conspicuous lines: in any bay or 20 feet maximum - $\frac{1}{4}$ " ; in 40 feet or more - $\frac{1}{2}$ ".
- Variation of the linear building lines from established position in plan and related portion of columns, walls and partitions.
- In any bay or 20 feet maximum - $\frac{1}{2}$ " ; in 40 feet or more - $\frac{3}{4}$ "
- Variation in cross-sectional dimensions of columns and in the thickness of walls is plus or minus $\frac{1}{4}$ ".

04 01 00 Maintenance of Masonry

04 01 20 Maintenance of Masonry

Part 1 – General

N/A

Part 2 – Products

N/A

Part 3 – Execution

Cleaning

All masonry work shall be cleaned and sealed before final inspection and acceptance. Acid wash is **not** usually an acceptable method of cleaning. Contractor shall be required to submit proposed procedures and to provide samples of materials where cleaning methods have been tested prior to beginning cleaning operations.

Restoration

Masonry restoration on any building in the designated historic district must comply with Arizona Historical Society requirements. Special attention shall be paid to match existing stone, brick, mortar colors and mortar joints.

Repair and Replacement

Extra stock materials shall be provided per NAU Technical Standards Section 01 78 46 Extra Stock materials.

04 05 13 Masonry Mortar

Part 1 – General

Section Title
Number

All mortar used for masonry construction shall meet the mortar and proportion specifications of ASTM C270. For re-pointing historic structures, DP shall evaluate structural integrity and justify mortar choices using test results for the adjacent masonry units. Type S, N, or O may be selected. Choosing a mortar that is stronger than the masonry may result in cracking of brick or stone units.

Part 2 – Products

N/A

Part 3 - General

Mortar Coloring Materials

Mortar colorants require Owner approval. Final color selection shall be determined from review of a selection of mock-up panels to be constructed by the Contractor. Mock-up panels shall remain on-site for job duration. Premixed/proportioned mortars ordered in large quantities and stored in bags or in a silo on site are recommended for colored mortars. Addition of color to mortar by hand or by the shovel method results in inconsistency in mortar color and is prohibited.

04 05 23 Masonry Accessories

Part 1 – General

Masonry Anchors and Tie Systems

Anchors or ties (including veneer anchors) embedded within masonry systems shall be galvanized and placed in such a way that they are completely covered with mortar.

Design Professional to include anchoring and mechanical fastening details in masonry drawings per structural evaluation and design of wall systems.

Design anchors and ties for steel stud, concrete and concrete masonry unit walls. Veneer back-up for concrete masonry units, or structural steel studs will include a 3/4" substrate/backerboard. Owner has pre-approved the following manufacturers to be in compliance with these standards: "WonderBoard".

Control Joints

Control joints shall be incorporated into straight wall masonry construction which exceeds forty feet. Spacing of control joints shall be specified by the DP. Control and expansion joints widths shall be not less than 3/8" to allow for installation of backer rod and sealant.

Joint Reinforcement

Joint reinforcement is required and shall meet the seismic requirement detailed in the International Building Code. A minimum of nine gauge, mill galvanized horizontal wire reinforcing is required.

Section Title
Number

Flashing

Provide designs for through-wall concealed flashing at all shelf angles, lintels, ledges and other obstructions to cause downward flow of moisture within the wall. Inspection will be required prior to covering over flashing to confirm proper placement. Flashing above doors, mechanical room louvers, and windows to be seamless and end dammed. Detail all through wall flashing to prevent contact with sealant.

Weepholes

A minimum of ¼ inch diameter by four-inch-long polyethylene plastic tubing for weep holes.

Lintels

Provide masonry or steel lintels wherever openings are more than one-foot wide for brick size units and two foot for block size units. Provide steel, precast or formed-in-place masonry lintels for all larger openings. Cure precast lintels before handling and installation. Provide appropriate formwork and false work support for formed-in-place lintels.

Caulking and Sealants

Waterproofing sealer shall have a minimum of five years guarantee for performance without breakdown from UV exposure.

All joints that require a caulking should receive special attention during construction. All joints are to be filled as soon as possible during construction and noted on the as built plans to be included in a FS Maintenance Program.

Admixtures

The use of mortar or grout admixtures, other than color pigments, shall not be allowed. Specifically prohibit the use of any mortar retarding agents due to their unpredictable nature.

Part 2 – Products

N/A

Part 3 - General

N/A

****END OF SECTION****

Section Title

Number

04 20 00 UNIT MASONRYPart 1 – General

Unit masonry selected for building exteriors shall be in accordance with the Owner's materials palette.

Finished unit masonry shall be, and shall remain, free from efflorescence and discoloration. Precautions to ensure this shall include: materials handling (storage of masonry on pallets with covers to keep masonry clean and dry), covering unfinished work and protection from moisture, sealants such as blocktite or mortar mixes, washing and waterproofing of walls, and specification of ASTM Test E-67 (efflorescence test) on large projects. Brick and concrete unit installations shall carry a two-year warranty against efflorescence.

Part 2 – Products

N/A

Part 3 – Execution

Composite walls with integral insulation are the preferred for walls with exterior masonry. Walls may be steel stud, cast-in place or precast concrete or concrete masonry unit structural walls with a brick, CMU, or stone veneer. Wall designs will include a moisture management system to direct water away from wall crown this includes roofs and overhangs for covered walls and precast concrete or metal copings for parapets. Slope sills, projections and other horizontal surfaces and to carry moisture out from walls.

A two-inch minimum air space shall be maintained between face brick and cavity insulation. Cavity shall be unobstructed, free from mortar drippings.

Workmanship

All mortar joints should be full joints.

Partially completed walls should be covered at the end of each working day, or when work is not in progress, with a strong weather resistant material to prevent contamination. Covers shall drape over both sides and be securely fastened.

All materials should be stored in a dry area. To prevent contamination of materials, masonry units, cements, limes and sand should not be stored on the ground.

Attic Stock

Extra stock materials shall be provided in accordance with the NAU Technical Standards Section 01 78 46 Extra Stock materials.

Section Title

Number

04 21 00 Clay Unit and Brick VeneerPart 1 – GeneralBrick Masonry

Brick selected for building exteriors shall be in accordance with the Owner's materials palette.

Materials shall conform to ASTM standard specifications including C216 (Facing Brick), C652 (Hollow Brick) and C270 (Mortar for Unit Masonry) C62 (Building Brick), ASTM C902 (Pedestrian and Light Traffic Paving Brick). All materials shall be rated for Severe Weathering or (SW) class.

Wall designs will include a moisture management system to direct water away from wall crown this includes roofs and overhangs for covered walls and precast concrete or metal copings for parapets.

Slope sills, projections and other horizontal surfaces and to carry moisture out from walls.

Part 2 – Products

N/A

Part 3 - Execution

To minimize brick color variations, the project's brick masonry and brick veneer masonry should be fired and supplied in one continuous run. If variations in color exist within the run, the differently shaded bricks shall be randomly intermixed as the wall is constructed. Obvious delineations in the brick color are not acceptable. Sample panel shall include an example pattern of intermixed or same run brick.

04 22 00 Concrete Unit MasonryPart 1 – General

Concrete unit masonry is an accepted method of construction. Decorative CMU's, splitface, or founders block are some types of concrete units currently in use.

Pedway Construction

Concrete unit paving stones are preferred for flat work in traffic areas (see section 32 13 16 for details), especially for pedway construction. Colors and unit type shall be consistent with those currently in use.

Part 2 – Products

N/A

SectionTitle
Number

Part 3 - Execution
N/A

04 23 00 Glass Unit Masonry

Part 1 – General

Glass unit masonry (glass block) selected for building exteriors shall be in accordance with Owner’s materials palette.

Part 2 – Products
N/A

Part 3 - Execution
N/A

****END OF SECTION****

SectionTitle

Number

04 40 00 STONE ASSEMBLIESPart 1 – General

Stone selected for building exteriors shall be in accordance with the Owner's materials palette.

All exterior stone veneer shall be designed to use mechanically fastened stone rather than adhesive attachment for its primary attachment method. The preferred backing wall is CMU.

Part 2 – Products

N/A

Part 3 - Execution

N/A

04 42 00 Exterior Stone CladdingPart 1 – General

All exterior stone cladding shall be designed to use mechanically fastened stone rather than adhesive attachment for its primary attachment method.

Part 2 – Products

N/A

Part 3 - Execution

N/A

04 43 00 Stone MasonryPart 1 – General

Stone masonry walls are composite walls and shall be constructed in conformance with 04 20 00.

Part 2 – Products

N/A

Part 3 - Execution

N/A

****END OF SECTION****

DIVISION 5 - METALS

Section Number	Title
05 40 00	COLD-FORMED METAL FRAMING
05 41 00	Structural Metal Stud Framing
05 50 00	METAL FABRICATIONS
05 51 00	Metal Stairs
05 51 13	Metal Pan Stairs
05 52 00	Metal Railings
05 52 13	Pipe and Tube Railings
05 58 00	Formed Metal Fabrications

DIVISION 5 - METALS

Section
Number

Title

05 40 00 COLD-FORMED METAL FRAMING

05 41 00 Structural Metal Stud Framing

Part 1 - General

Owner requires all new construction to follow the requirements of the 2009 ICC International Building Code, Chapter 22, STEEL.

In addition, all wall framing to follow the following:

Walls up to 10' cold rolled studs to be 25 gauge.

Walls over 10' to 14' cold rolled studs to be 20 gauge.

Walls over 14' cold rolled studs to be 16 gauge.

All wall studs to be minimum 16" on center.

Additional standards for cold formed stud walls as cited in the IBC are: AISI S211 or AISI S100.

Part 2 – Products

N/A

Part 3 – Execution

N/A

05 50 00 METAL FABRICATIONS

Part 1 - General

This section applies to all metal fabrications that have a visual aesthetic impact both interior and exterior.

Part 2 – Products

Metal used for interior railings should be tube stock, not solid stock, and conform to ASTM A 500.

Part 3 – Execution

Welds should be smoothly ground to match surface texture of parent metal. All gaps, holes and gouges should be filled with a permanent material (solder or brazing). Design limitations of grinders, files etc., dictate that adjoining metal tubing pieces at angles less than 125° generally need a minimum of 1/4" radius butt weld in order to grind smooth.

Fully conceal adjoining railing splices in runs that appear constant. At elbow bends, utilize mitered joints.

DIVISION 5 - METALS

Section
Number

Title

Limiting unsupported length should not exceed 6' for diameters 2" or less. Cable used as railing intermediates is not allowable.

The use of expansion bolts to secure railing assemblies to vertical or horizontal surfaces is not allowable. Anchorage systems should consist of direct imbeds (sleeved or plates) and/or welding.

Exterior exposed metal fabrications shall have a spray applied epoxy-polyimide type primer paint and spray applied finish paint-epoxy based and/or electrostatically applied. A color should be chosen that does not easily fade when exposed to sunlight and hides hand prints. Ladders shall be a minimum width of 18", 3/4" diameter rungs spaced 12" o.c., braced a minimum of 5' o.c. Rungs should have a non-slip type finish.

All stair nosings shall have a permanently applied non-slip surface, either integral or imbedded, 2" wide minimum the width of the tread.

Where metal stair risers are exposed (not covered), they shall have spray applied epoxy-polyimide type primer paint and spray applied finish paint-epoxy based and/or electrostatically applied. A color should be chosen that does not easily fade when exposed to sunlight and hides the shoe-scuff marks.

At the top and bottom of stair landings, a contrasting color and texture to the normal stair treads shall be used to facilitate the blind and visually impaired.

Expansion joints should be provided in continuous runs at a minimum interval of 40 feet.

All exposed to public fabrications with right angles corners shall be radiused a minimum of 1/8".

Metal trim in continuous runs shall have concealed splices and be of sufficient gauge that natural distortions are not visually apparent. All exposed edges to the public shall be radiused or sharp edges eased.

Shop Drawings:

1. Submit shop drawings for custom fabricated items, including:
 - a. Profiles, sizes, connection attachments, reinforcing, anchorage, size and type of fasteners and accessories.
 - b. Erection drawings, elevations and details.
 - c. Welded connections using standard AWS welding symbols.

Product Data:

Submit product data for manufacturer's stock items.

DIVISION 5 - METALS

**Section
Number**

Title

Certifications:

- 1. Submit current welder's certification qualified in accordance
- 2. Submit certification by fabricators that handrails and stairs have been designed by a structural engineer licensed in the State of Arizona.

05 51 00
05 51 13

Metal Stairs

Metal Pan Stairs

Part 1 - General

Metal pan stairways are the preferred product for interior locations. Alternatives require prior approval by Owner. Open risers are not permitted. Provide colored safety edge at the top and bottom steps, color as selected by the Owner. All stair nosings shall have a permanently applied non-slip surface, either integral or imbedded, 2" wide minimum the width of the tread.

Metal pan stairways shall not be specified for unprotected exterior locations.

Part 2 – Products

N/A

Part 3 – Execution

N/A

05 52 00
05 52 13

Metal Railings

Pipe and Tube Railings

Part 1 - General

In general, handrails are required for both sides of all stairs, ramps, etc.

Exterior handrails must conform to the Landscape Master Plan.

Part 2 – Products

N/A

Part 3 – Execution

N/A

05 58 00

Formed Metal Fabrications

Part 1 – General

N/A

Part 2 – Materials

DIVISION 5 - METALS

**Section
Number**

Title

Metal bollards for protection (i.e. fire hydrants, generators, transformers, trash enclosures, etc.) shall be a minimum of 6" diameter round, schedule 40 steel, filled with 4,000 PSI concrete.

Traffic control bollards see Division 32.

Part 3 - Execution

Exterior metal bollards for protection shall be directly set in concrete slab and shall be a minimum of 1/3 the exposed height below the finished adjacent surface.

Interior metal bollards may be directly set or surface bolted to an embedded plate.

*** * * END OF SECTION * * ***

DIVISION 6 - WOOD, PLASTICS, AND COMPOSITES

Section Number	Title
06 20 00	FINISH CARPENTRY
06 20 23	Interior Finish Carpentry
06 40 00	ARCHITECTURAL WOODWORK
06 41 00	Architectural Wood Casework
06 41 93	Cabinet and Drawer Hardware

DIVISION 6 - WOOD, PLASTICS, AND COMPOSITES

Section Number	Title
06 20 00	FINISH CARPENTRY <u>Part 1 – General</u> Formaldehyde containing particle board and similar composition products are not encouraged, and must be approved by Owner. Formaldehyde off-gassing rates are to be less than 0.03 milligrams per square foot of surface/hr in accordance with ASTM D5116-90. <u>Part 2 – Products</u> N/A <u>Part 3 – Execution</u> N/A
06 20 23	Interior Finish Carpentry <u>Part 1 – General</u> Synthetic counter tops shall be high pressure laminate, or, in extra heavy duty use applications, a solid surface, 1/2" minimum thickness. Guides for plastic laminate finishing are as follows: min. 0.050" exposed horizontal surfaces; min. 0.028" exposed vertical surfaces; min 0.020" cabinet linings and concealed backing. High moisture areas such as lavatory tops, coffee bar tops, or work surfaces that are repeatedly subjected to spillage, water cleaning, or subject to chemical substances shall have solid surface countertops and backsplashes <u>Part 2 – Products</u> N/A <u>Part 3 – Execution</u> N/A
06 40 00	ARCHITECTURAL WOODWORK <u>Part 1 – General</u> This section applies to architectural mill and casework. In general, the design and specification of items normally contained in this section must be considered to last the lifetime of the building (assume 50 years). Flexibility, years of heavy use and misuse, limited maintenance, high impact, occasional overloading and initial cost effectiveness should be the criteria in the design and finish. Endangered or limited tree species used as veneers or solid stock (mahogany, teak,

DIVISION 6 - WOOD, PLASTICS, AND COMPOSITES

Section
Number

Title

etc.) are not allowable. Soft species used for face veneers, tops, kick plates, bases or any other high impact or abrasion related use are not allowable.

Wood thresholds are not acceptable unless retrofitting historic buildings.

Part 2 – Products

N/A

Part 3 – Execution

N/A

06 41 00

Architectural Wood Casework

Part 1 – General

Case or millwork that will be specified as receiving a painted finish, should be limited to lower cost species (birch, poplar, etc.).

All cabinet and millwork tops, sides, dividers, shelving, etc., shall be 3/4" minimum stock. Stained veneer materials shall conform to Architectural Woodwork Institute (AWI) custom grade, minimum thickness 1/16".

Unexposed framing shall be nominal 1 x 2 hardwood, AWI custom grade.

Doors and drawer fronts shall be 3/4" minimum core stock.

Drawer boxes shall be 1/2" minimum with minimum 1/4" plywood bottoms.

Cabinet tops should be of sufficient height to comply with minimum disabled accessibility requirements.

Built-in shelving or free standing modular shelving height should not exceed 6' from finished floor (unless used in large storage areas) and be securely anchored to studs or to unit masonry walls that are reinforced to accept the loading.

All shelving should be designed as fully adjustable, 3/4" minimum thickness.

"Line bore and pin" method of shelving adjustment (either in cabinets or standing shelving) is desired. Shelf standards mortised in with brackets is also acceptable.

The use of painted particleboard as the finish for cabinets and tops is not acceptable. Particle board is allowable as core stock in low/no moisture areas when receiving a high pressure plastic laminate finish.

Particle board is not an acceptable material for shelving with greater than a 2-foot

DIVISION 6 - WOOD, PLASTICS, AND COMPOSITES

Section
Number

Title

unsupported span.

The use of melamine or other similar low mill finishes (less than .020") as interior cabinet lining or underside of shelving is not acceptable. Melamine thermo fused ¾" is acceptable for interior finish of cabinets only.

All countertops designed as work surfaces shall be of an appropriate height to accommodate the physically disabled.

All millwork designed to support electrical equipment (computers, phones, clocks, etc.) shall have grommet openings allowing cords, interconnect cables, etc., to be concealed or routed internally. Grommets shall be 2-1/2" minimum diameter plastic, color to match adjacent finish.

Part 2 – Products

N/A

Part 3 – Execution

N/A

06 41 93

Cabinet and Drawer Hardware

Part 1 - General

All millwork and accessory hardware shall comply with ANSI A156.9, minimum quality level Type 2 (institutional). Hinges, guides, slides, etc., shall utilize bearings complying with BHMA 201.

All cabinet hinges should be self-closing and spring loaded. Drawer slides should allow full extension (1" longer than total drawer depth) and be specified as heavy duty (100 lb. minimum).

All exposed cabinet hardware should be specified with a permanent, durable finish that is easily cleanable.

Refer to Division 9 for cabinet and drawer lockset specifications.

Part 2 – Products

N/A

Part 3 – Execution

N/A

*** END OF SECTION ***

DIVISION 7 - THERMAL AND MOISTURE PROTECTION

Section Number	Title
07 00 00	THERMAL AND MOISTURE PROTECTION
07 10 00	DAMPPROOFING AND WATERPROOFING
07 11 00	Dampproofing
07 13 00	Sheet Waterproofing
07 14 00	Fluid-Applied Waterproofing
07 20 00	INSULATION
07 21 00	Thermal Insulation
07 24 00	Exterior Insulation and Finish Systems
07 26 00	Vapor Retarders
07 30 00	STEEP SLOPE ROOFING
07 31 13	Asphalt Shingles
07 40 00	ROOFING AND SIDING PANELS
07 50 00	MEMBRANE ROOFING
07 51 00	Built-Up Bituminous Roofing
07 54 00	Thermoplastic Membrane Roofing
07 60 00	FLASHING AND SHEET METAL
07 70 00	ROOF AND WALL SPECIALTIES AND ACCESSORIES
07 72 00	Roof Accessories
07 76 00	Roof Pavers
07 80 00	FIRE AND SMOKE PROTECTION
07 82 00	Board Fireproofing
07 84 00	Fire-stopping
07 84 13	Penetration Firestopping
07 90 00	JOINT PROTECTION
07 92 00	Joint Sealants and Caulking

Section
Number

07 00 00 THERMAL AND MOISTURE PROTECTION

Part 1 – General

This general discussion section contains information that is critical to successful moisture protection systems in new construction and renovation, but which is not the sole responsibility of any individual trade. In many cases, the issues involved are fundamental to the basic design of the project.

BELOW GRADE SPACES

Wherever below grade walls are exposed to naturally occurring groundwater or substantial landscape irrigation water, even if simply foundation walls, include a foundation drainage system in addition to dampproofing or waterproofing the walls.

Foundation waterproofing shall meet the following minimum standards.

Hydrostatic Pressure Resistance	ASTM D 5385 (mod.)	231 ft. (70 m)
Permeability	ASTM D 5084	<1 x 10 ⁻¹¹ cm/sec.
Peel Adhesion to Concrete	ASTM D 903 (mod.)	10 lbs./in.
Grab Tensile Strength	ASTM D 4632	150 lbs.
Puncture Resistance	ASTM D 4833	70 lbs.
Elongation	ASTM D 4632	50%
Crack Bridging	ASTM C 836	Passed
Resistance to Decay	ASTM E 154	Passed
Permeance	ASTM E 96 B	0.03 Perms

TRAFFIC DECKS

Traffic bearing decks are very difficult and expensive to successfully waterproof and maintain. Avoid use of finished spaces with traffic decks exposed to the weather above them.

Part 2 – Products

Refer to sections below for products requirements & recommendations.

Part 3 – Execution

Refer to sections below for Execution requirements & recommendations.

****END OF SECTION****

Section
Number

Title

07 10 00 DAMPPROOFING AND WATERPROOFING

Part 1 – General

This section applies to waterproofing of building components that receive or are in and around areas to receive such treatment.

Waterproofing and dampproofing are not interchangeable materials. Project may have one, both, or neither.

Waterproofing is used on surfaces which enclose habited space and where moisture penetration is not acceptable.

Dampproofing is used to reduce moisture migration through exterior surfaces such as retaining walls and planters.

Where such surfaces are intended to be subject to foot traffic, and therefore are not "roofs", refer to the requirements of Section 07 59 00 Horizontal Traffic Surfacing.

The DP shall specify waterproofing assemblies to be procured from a single manufacturer.

The DP should provide manufacturer(s) capable of providing a 5 year warranty on the material(s) being specified and require that materials manufacturer(s) and installer(s) demonstrate 5 years of successful installations of similar systems.

Submittal of manufacturer's literature describing the system, and samples of proposed membrane materials is required

The DP should pay particular attention to the drainage course against the wall and to perimeter drains. Describe requirements for these elements on the drawings.

Cross reference with requirements of Division 2 (exterior finish grades) shall be specified to slope away from buildings.

Expanded warranties are required as follows:

- 5 year warranty from the installer covering defects in installation
- 10 year warranty from the materials manufacturer including defects in materials and installation, and guaranteeing to maintain the system in a waterproof or dampproof condition (as applicable) for the life of the warranty
- Include sealing of all perimeters, joints, and penetrations
- Renewal option for an additional 10 years from the materials manufacturer
- Full replacement value without proration

Section
Number

Title

Part 2 – Products

The use of asbestos-containing materials is expressly prohibited

Require that all materials be supplied by a single manufacturer, or approved by the primary materials manufacturer, to ensure single-point responsibility for the installation and warranty.

Part 3 – Execution

A pre-installation conference is required and to be scheduled after the substrates are complete. The meeting shall include the Contractor, Design Professional, Owner, materials manufacturer, and installing subcontractor(s).

Inspection of waterproofing is required prior to covering over the membrane. DP shall specify proper notification time, following Owner's Inspection Process. DP shall provide special inspection services of any caulking and waterproofing systems.

The DP should specify that before covering waterproof membranes on horizontal surfaces with other materials, a leak test be performed with a 2" depth of water maintained for 48 hours. Such test shall be conducted by the Contractor or subcontractor and witnessed by a representative of the DP and Owner.

Require that the in-progress installation be observed by the materials manufacturer to ensure that the complete assembly will qualify for the required warranty.

Require that all penetrations be installed in the wall prior to membrane application, so they can be properly sealed by the membrane installer. Avoid the installation of unnecessary sleeves and pay particular attention to the detailing of those that are required.

07 11 00

Dampproofing

Part 1 – General

See above section 07 10 00

Part 2 – Products

Specify a dampproofing system which includes the following:

- Joint preparation
- At least two layers of trowel-grade bituminous coating with interweaved mesh membrane reinforcement
- Termite-resistant protection board embedded in bituminous coating to prohibit displacement

Section
Number

Title

Part 3 – Execution

See above section 07 10 00

07 13 00

Sheet Waterproofing

Part 1 –General

See above section 07 10 00

Part 2 – Products

Specify a sheet waterproofing system which includes the following:

- Joint preparation
- Continuous self-healing sheet membrane
- Termite-resistant protection board embedded in a fluid-applied coating to prohibit displacement

Part 3 – Execution

See above section 07 10 00

07 14 00

Fluid-Applied Waterproofing

Part 1 – General

See above section 07 10 00

Part 2 – Products

Specify a sheet waterproofing system which includes the following:

- Joint preparation
- Fluid-applied membrane which cures in place to form a continuous monolithic self-healing membrane
- Termite-resistant protection board embedded in a fluid-applied coating to prohibit displacement

Part 3 –Execution

See above section 07 10 00

****END OF SECTION****

Section Number	Title
07 20 00	INSULATION
07 21 00	Thermal Insulation

Part 1 – General

This section includes insulation used for thermal purposes, and which is installed as an independent material. Insulation which is an integral of a specific system (e.g. membrane roofing or exterior insulation and finish systems), is described in the appropriate Sections. Such insulation may be included in the total assembly R-value. However, such insulation must not be the sole source of thermal resistivity for the building. Design building surfaces which experience a significant temperature differential across their thickness to meet the following thermal resistance ("aged R-value") criteria:

- Roofing systems in conjunction with proposed insulation or other exposed horizontal surfaces shall attain a minimum composite R value of 38, and meet ASHRAE 189.1 standards.
- Walls or other exposed vertical surfaces shall attain a minimum R value of 20, and meet ASHRAE 189.1 standards.

Design Professional to specify by type and manufacturer, stating performance characteristics of density, aged average R value per inch, flame spread and fire rating.

Generally, (unless noted otherwise), all corridor, restroom, classroom, laboratory, conference, meeting, lobby, and office walls and ceilings shall be fully sound attenuated.

For air-borne and structure-borne sound provide walls, partitions and floor/ceiling assemblies separating spaces from each other with a sound transmission class (STC) of not less than 50 when tested in accordance with ASTM E90.

STC ratings higher than STC 60 shall be specified in sensitive areas where sound transmission is a concern. Sensitive areas include testing areas and music practice rooms, as well as any other areas identified by Owner during design phase.

STC is highly dependent on the construction of the partition. A partition's STC can be increased by:

- Adding mass
- Increasing or adding air space
- Adding absorptive material within the partition

Where blanket type insulation or sound attenuation material is being utilized in open plenum areas, it should be specified as being "kraft" or foil faced and backed

Section
Number

Title

(depending on installation). Do not specify any form of insulation to be laid directly on accessible ceilings. Instead, detail horizontal insulation at the top of the cavity, and extend vertical insulation up to that level.

THERMAL INSULATION - Roofs, Attics, and Other Roofs (ASHRAE Design Guide)

Where Vinyl faced insulation is used, facing materials are applied to fiber glass blankets to serve as a vapor retarder as well as a protected cover over the fiberglass. In metal buildings, banding can be used to secure insulation in a roof or walls. Screw attached steel bands to the underside of the metal purlin 30” apart creating a grid system. Ensure that all joints are properly sealed/taped to maintain continuity of vapor barrier.

Minimum insulation is R-38.

Part 2 – Products

The use of asbestos-containing materials is expressly prohibited

Specify ASTM C1289 Type II polyiso insulation.

Fiberglass insulation shall have an integral kraft paper or foil vapor barrier.

Use of blown-in insulation is prohibited unless approved by Owner in writing.

Part 3 – Execution

Replace all insulation that becomes wet.

Specify mechanical attachment for all insulation. Do not specify insulation to be adhesive applied or installed loose.

All insulation needs to be securely attached.

07 24 00 Exterior Insulation and Finish Systems

Part 1 – General

During installation of the EIFS, DP shall perform jobsite to ensure proper installation procedures (as recommended by manufacturers and as designed by DP) are followed by all Contractors (this would apply to all contractors involved with the installation of the system such as exterior framing, drywall, EIFS, windows, and roofing Contractors.

Installer’s experience & expanded warranties are required as follows:

A special 5-year guarantee against defects in materials and installation is required; including attachment failure, delamination, cracking, peeling, and fading. Only those

Section
Number

Title

manufacturers that can comply with this warranty shall be used.

Warranty shall be submitted and approved by Owner before notice to proceed is issued to Contractor.

A single installation contractor shall perform the work, and have not less than 5 years of successful experience in the installation of exterior insulating finish systems:

- The subcontractor shall provide a list of projects done within the last 5 years under similar climate and elevation using a system similar to the one specified. Listing of comparable projects shall include references and contact information.

Proof of installer's experience: The Contractor shall provide the installation contractor's documentation to Owner proving the installation contractor meets the requirements of the specifications or the installation contractor may be rejected. Owner may ask for Contractor to revise and resubmit with a different installation contractor. Proof would entail a list of projects and materials used with referenced attached. This information is required before Notice to Proceed is issued.

All materials manufacturer(s) and applicator(s) must demonstrate 5 years of successful installation of similar systems under similar climate (climate zone 5 or higher) and elevation (5,000 feet or higher).

Installation contractors must be approved and licensed by the materials manufacturer.

Part 2 – Products

EIFS performance shall comply with the following:

- Weathertightness: resistant to water penetration from exterior into EISS and assemblies behind it or through them into interior of building that results in deterioration of thermal-insulating effectiveness or other degradation of EISS and assemblies behind it, including substrates, supporting wall construction, and interior finish.
- Bond Integrity: free from bond failure with EISS components or between system and supporting wall construction, resulting from exposure to fire, wind loads, weather, or other in-service conditions.

All materials must be supplied by a single manufacturer, or approved by the primary materials manufacturer, to ensure single-point responsibility for the installation and warranty. Only extruded polystyrene insulation board, with Class A flame spread and smoke developed characteristics are approved for use.

Only acrylic-modified Portland cement adhesive and base coat are approved for use.

Section
Number

Title

Only 100% acrylic, integrally colored finish coat, without the need for additional pigmented coatings is approved. Where the system will be exposed to potential physical abuse, use only manufacturer's standard "high impact" components.

Submittals are required of all control joint and expansion joint locations.

Part 3 – Execution

Mock-up required upon Owner request.

The system must be installed in accordance with the manufacturer's recommendations.

Applicators must maintain a "wet edge" until a natural break point is achieved.

Scaffold lines and cold joints are expressly prohibit.

Installation of Exterior Sheathing Materials

Panel Selection and Application:

To increase stiffness, panels shall be applied with the strength axis across the studs. For stud spacing of 16 inches on center, APA makes the following recommendations:

With the strength axis perpendicular to the studs – 3/8" and 7/16" minimum panel thickness and minimum span ratings of 24/0 and 24/16. With the strength axis parallel to the studs – 15/32" and 1/2" minimum panel thickness and a minimum span rating of 32/16 for OSB or 5-ply/5 layer plywood. Structural 1 Rated Sheathing (OSB) 7/16" thickness and span rated 24/16 may also be used. The above will require sheathing to be installed with the long side horizontal (where strength axis runs in the long panel dimension), with blocking between studs along horizontal panel joints.

Spacing Requirements:

Spacing of 1/8" is required at panel ends and edges. This allows for some minor panel swelling if wetting occurs during the construction process. Greater spacing may be required at locations of expected movement, such as the band joist, particularly when using surfaced green dimensional lumber.

Nailing Pattern/Schedule:

Owner requires nailing 6" o.c. along supported panel edges and 12" o.c. at intermediate supports with 6d common nails, or 16 ga. 7/16" crown 1-3/4" leg staples, or 1-5/8" length nails with a shank diameter of .097"-.099". All fasteners are to be located 3/4" from panel edges. For shear wall applications closer spacing or different sizes will be necessary.

Section
Number

Title

Installation of Weather Resistive Barrier (WRB) or Secondary Drainage Plane

This is a layer, separate from, and in addition to, the paper found immediately behind the stucco lath. While there are several materials that can be used to create a drainage plane, there is similarity in their installation. All are installed in a shingle type fashion, so as to shed water from the upper layer(s), out over the lower layers, and ultimately back to the outside of the wall. Installation starts at the bottom of the wall and works upward, overlapping successive courses. This installation must be continuous and prevent water from finding its way into the wall cavity. As such, special attention must be paid to details of interfaces between the secondary drainage plane and windows, doors, roofs, flashings, etc. With drainage plane installed no sheathing should be exposed and any tears in the drainage plane must be repaired. The drainage plane must run under windows, corner boards, window wraps and around corners.

Acceptable Materials:

Commercial building-wrap. The material must be vapor permeable to allow water vapor to pass thru the wall; however, it must be water resistant.

Installation Methods for Building Paper and Felt:

Paper can be installed prior to, or after, window installation. Special care must be taken at the interface with windows and doors (see Installation of Windows). The installation starts with the bottom course being applied. Subsequent courses are installed horizontally (not at an angle) working upwards, in shingle fashion. The horizontal lap must be at least 2". At end laps there must be at least a 6" lap. At corners (inside or outside, the paper must run at least 6" around the corner. At inside corners, care must be taken to keep the weather resistant barrier tight to the corner so lath can later be installed. Where intersecting a roof the paper should overlap the upturned leg of step or headwall flashings. Paper should be fastened with crown staples (at least 1"), cap nails, or large head nails every 12" to 18". Best practice is to fasten the studs, not sheathing, so the lath installer can locate studs.

Installation Methods for building-wrap:

Commercial building wrap can be installed prior to, or after, window installation. Special care must be taken at the interface with windows and doors (see Installation of Windows). The installation starts with the bottom course being applied. Subsequent courses are installed horizontally (not at an angle) working upwards, in shingle fashion. Some building wraps can be applied in only one direction, some have an inside and outside face. The horizontal lap must be at least 6". At end laps there must be a 6" lap. At corners (inside or outside), the building-wrap must run 6" around the corner. As previously stated, care must be taken to keep the weather resistant barrier tight to the corner so that lath can later be installed. Where intersecting a roof the building wraps should overlap the upturned leg of step or headwall flashings. Building wraps should be fastened with wide crown staples (at least 1"), cap nails, or

Section
Number

Title

large head nails every 12" to 18". Refer to the manufacturer's installation instructions for further information. Best practice is to fasten through sheathing to studs, so the lat installer can locate studs.

Installation of Windows, Doors, and Trim & Integration to Drainage Plane

Window Installation:

It is required that the installation of the first layer of protection (the one closest to the sheathing), the weather resistive barrier, be done prior to the windows and doors being installed. Installing windows with brick mold creates additional considerations. Building wraps must be installed before the window is installed. First, building wraps is installed, and then a pan flashing should be installed at the rough sill and integrated with the building wraps. A bead of sealant must be applied to the backside of the brick mold, or on the wall to bed the brick mold on three sides, before installation of the window. Drip cap flashing must be installed at the head of the brick mold. The use of casing bead, backer rod and proper caulk will be used for the head, sides and still.

Door Installation:

When installing doors, which typically have brick mold, the steps outlined for windows will be followed. Extra care should be given to doors that are not protected by some form of overhang. Casing bead, backer rod and proper caulk at the joint between stucco and brick mold will be used.

Window Trims:

When trimming windows with wood trim the contractor must be aware of the dissimilar movement between the various materials when changes in temperature and moisture occur. For example, vinyl windows will move more than wood trim, which will move more than stucco. Because of this, backer rod and proper caulk at these joints, along with a properly designed joint will be used.

Drip Cap Flashing Integration:

Drip cap flashing will be installed above all projecting wood trim and above windows that do not have a self-flashing nailing fin. This flashing is installed with the vertical back leg on the outside of the drainage plane. When the paper immediately under the lath is installed, it will overlap the back leg in a shingle type fashion.

Roofing integration to the Drainage Plane

Key Elements:

Roof flashings must provide proper "kick out" from behind all siding, stucco and others. The vertical "back leg" of roof flashings must be installed behind the drainage plane. Stucco must not be installed until proper kick out flashings is achieved.

Roof installation is to be performed in a fashion whereby roof flashings are installed to

Section
Number

Title

provide proper “kick out” to divert precipitation (run-off) to the exterior of the siding product.

Contractor required to furnish and install “oversized” kick out flashings at all areas of the roof where flashings must be deliberately drawn out from behind the siding. Specifically, pre-manufactured, oversized kick out flashings are recommended at the 1st course or row of roofing, when the 1st course or row of roofing abuts stucco. The 1st flashing, where abutting a stucco wall, should be an oversized/pre-manufactured kick out flashing to divert water from behind the stucco into gutter.

At all exterior corners where “kick out” is required; flashings must extend sufficiently past the corners. 2-inch minimum extension is recommended. The vertical leg of roof flashings should be a minimum of 3-inches tall, but should be fabricated to only rise 2-inches vertically at the extended portion of the flashing (portion of flashing properly extending past corner). This allows the stucco contractor to then install the casing bead 2-inches above the roof deck, providing an approximately 1-inch overlap of the vertical leg of the roof flashing, without having to modify the roofing contractors work, where flashing extends past the corner. If any modification of roof flashings or roofing materials is believed necessary, it is recommended the roofing contractor be called upon to perform it. With the intent of being able to provide for the future replacement, maintenance, and repair of roof flashings at wall junctures, best practice will insure that flashings are not permanently imbedded behind stucco siding. Two possible means by which this can be achieved include:

- Wall flashings may be covered by wood trim, which is installed with a drip cap.
- The casing bead channel at the bottom of stucco siding can be installed in a fashion which allows for roof flashings to be easily maneuvered behind the “J” channel flashing or out from behind the “J” channel flashing.

Roof flashings shall be properly installed behind the drainage plane.

Flashings, for the purpose of this specification shall be defined as those building materials used in effort to provide a watertight “connection” between the roof and any protrusion through, or adjacent to, the roof plane (i.e. sidewalls, chimneys, vent pipes, skylights, etc). Drainage plane, for the purpose of this specification shall be defined as the inner most water resistive barrier, installed on the exterior of the sheathing for the purpose of protecting the interior from the intrusion of water.

The back leg of all roof flashings must be installed with the upturned vertical leg behind the drainage plane. All roof flashings must be installed in a fashion whereby proper “kick out” of flashings from behind the drainage plane is achieved, as necessary to divert precipitation (run-off) to the exterior of siding. Stucco shall not be installed until proper kick out is provided. Those installing stucco siding must be sufficiently

Section
Number

Title

knowledgeable in recognizing the proper installation of necessary kick out flashings.

The stucco contractor bears responsibility for knowing that application of stucco siding over flashings that do not divert water to the exterior of siding will likely result in water intrusion of the interior and is therefore improper. If there is any question that flashings will not provide proper kick out, the stucco contractor shall not install stucco at questionable areas until the flashing unquestionably provides proper kick out.

Under no circumstance should stucco siding be installed over flashings which would fail to properly divert/precipitation/moisture past the exterior surface of the stucco siding.

Integration of Penetrations to the Drainage Plane

Generally, small penetrations through the stucco can be caulked to successfully keep water out of the wall. Several areas that warrant specific attention are listed below.

Plumbing penetrations:

Sillcocks, installed in walls that are to have stucco applied, should be held out of the wall to accommodate the thickness of the stucco. After the stucco has been installed the sillcock should be caulked to the stucco wall.

Electrical penetrations:

Electrical boxes, used in walls that are to have stucco applied, should be held out of the wall to accommodate the thickness of the stucco. After the device is installed, it should be caulked to the stucco wall. Examples include lighting fixtures, weatherproof receptacles, etc.

Electrical Meters:

Electrical meters, in walls that are to have stucco applied, should be installed over the drainage plane, or installed with a weather resistive barrier behind it, to later interface with the drainage plane. A drip cap flashing should be considered for placement above the meter can. The vertical back leg of the flashing should be on top of the drainage plane. The paper behind the lath should go over this back leg. After installation of the stucco, the meter can sides and bottom should be caulked to the stucco.

Other Penetrations:

Walls may have many other penetrations such as dryer vents, fireplace termination caps, and furnace exhaust. Each of these must be sealed to the stucco wall with an appropriate sealant.

Lath Installation Requirements

Lap metal lath ½" minimum on sides (the long dimension) and 1" on ends (the short

Section
Number

Title

dimension). End laps should occur over studs.

For paper backed lath, the vertical and horizontal joints should be backing-to-backing, and metal on metal. The paper should never extend over the lath and should be shingled. Metal plaster bases should be attached to the framing members (studs) at not more than 7" along framing members. It is intended to have the lath attached to the studs. The attachment should be thru the self-furring mechanism only, i.e. fasten through dimples or v-groove, so as not to reduce embedment of the lath in the stucco. In lieu of wire tying the lath, a limited number of staples may be utilized to secure the lath to the exterior façade. Care should be taken so as to not over staple self-furring lath. Over stapling can depress the lath to a point where it is impossible to get the lath imbedded into the plaster cement. The fasteners used to attach the metal base must penetrate studs $\frac{3}{4}$ ". As staples are prevalent, they would need to be a minimum of 1 $\frac{1}{4}$ " in length (assuming 7/16 inch sheathing), with a crown of not less than $\frac{3}{4}$ ".

Metal lath should be applied with the long dimension at right angles to support. For narrow wall panels (less than 24 inches), it is generally acceptable to apply the long dimension parallel to the framing members. It shall be permissible to follow the roof rake on gables. End of adjoining plaster bases should be staggered. Lath will not be continuous through control (expansion and contraction) joints. It will be cut, with the accessory attached over the lath and attached (wire tied or stapled) at each side, not more than 7" o.c. When cutting the lath care must be taken not to damage the weather resistant barrier (the drainage plane closest to the sheathing).

Control/expansion joints should be installed to delineate areas of not more than 144 sq.ft. The distance between control/expansion joints shall not exceed 18ft. in any direction or a 2-1/2 to 1 length to width ratio. Control/expansion joints should be located where movement is anticipated. Where expansion joints intersect in a perpendicular fashion the vertical member shall be installed first and shall be continuous.

External corner reinforcement shall be used where corner bead is not used.

At internal corners, there are various details that one may follow dependent upon the situation. When installing the lath or accessory, extreme caution and care shall be taken to avoid damaging the weather resistive barrier (WRB). To avoid tearing, try to keep the WRB tight to the corner. The size of the casing bead and other accessories shall be compatible with the thickness of the plaster that is to be applied. For traditional $\frac{3}{4}$ inch stucco work, these accessories shall be $\frac{3}{4}$ inches. Smaller sizes may be used with listed stucco products. Lath is to terminate above stoops and other concrete flatwork. Framing must be protected from pouring concrete directly against it. The use of foundation weep screeds is required. The purpose of the weep screed is

Section
Number

Title

to allow any water that may be flowing across the drainage membrane a means to escape.

Stucco Applications

A three coat stucco system shall consist of a separate scratch, brown, and finishing coat with a total thickness of 7/8". Products that have received an evaluation report and number from the ICC-Evaluation Service would fall under the category of "alternative materials". There are several proprietary "one coat" products that have an ICC-Evaluation Service listing. Typically, these products come premixed, and when applied according to the manufacturer's installation instructions, they may be applied in one coat with a second topcoat being applied at a later time. Stucco wall covering of any kind shall not be applied until the drywall and roofing materials have been installed. This allows loading of the wall systems as well as eliminating any hammering on the exterior walls that could potentially cause cracking to occur. There are several types of acceptable topcoats. Some are portland based finish, acrylic, elastomeric, and latex. The contractor should be aware of potential incompatibility between some of the finishes and the base coat(s) due to the alkalinity of the stucco.

Weatherproofing and Application of Sealants

Backer rod limits the depth of the caulk. The depth of a caulk joint should not exceed its width. The minimum width of a caulk joint should be ¼". The ability of the joint to flex and remain adhered is greatly influenced by the type of caulking material used. A good quality acrylic-latex shall be used for some applications that are less critical. For joints where water sealing is critical, or difficult to access, the use of a better material such as urethane or silicon will be used. It is recommended that all joints between dissimilar surfaces in a stucco wall be caulked. This would include, but not limited to, windows to wood trim, wood trim to stucco (wraps, corners, bands, etc.). Do not caulk metal head flashings, z-bar flashing, or anywhere water would normally escape the wall.

07 26 00

Vapor Retarders

Part 1 – General

Vapor and Air Retarders (ASHRAE Design Guide 90.1)

The air barrier system should have the following characteristics:

- It should be continuous, with all joints made airtight
- Air barrier materials used in frame walls should have an air permeability not to exceed 0.004 cfm/ft² under a pressure differential of 0.3 in. water (1.57 lb/ft²) when tested in accordance with ASTM E 2178.

The system shall be able to withstand positive and negative combined design wind,

Section
Number

Title

fan, and stack pressures on the envelope without damage or displacement, and should transfer the load to the structure; it should not displace adjacent materials under full load.

It shall be durable and maintainable.

The air barrier material of an envelope assembly shall be joined in an airtight and flexible manner to the air barrier material of adjacent assemblies, allowing for the relative movement of these assemblies and components due to thermal and moisture variations, creep, and structural deflection.

Connections shall be made between:

- foundation and walls
- walls and windows or doors
- different wall systems
- walls and roof
- walls and roof over unconditioned space
- walls, floor, and roof across construction, control, and expansion joints
- walls, floors, and roof to utility, pipe, and duct penetrations

All penetrations of the air barrier system and paths of air infiltration/ex-filtration should be made airtight.

Note: installation of an under-slab vapor barrier should also be specified in Division 03 30 00 and detailed directly under the concrete slab and on top of any subgrade or sand grading material to minimize moisture transmission through the slab. Barriers shall be specified for all construction.

Vapor Barrier Criteria: Refer to Section 07 00 00 Part 1, General for Vapor Barrier Criteria. If vapor barrier is required then it shall be specified in Section 03 30 00.

Part 2 – Products

N/A

Part 3 – Execution

N/A

****END OF SECTION****

Section Number	Title
07 30 00	STEEP SLOPE ROOFING

07 31 13 Asphalt Shingles

Part 1 – General

Systems described in this section are intended to be installed in situations where the roof slope is at least 4 inches per foot, and where the roofs are not intended to receive regular foot traffic for equipment maintenance.

A complete roofing system, making the materials manufacturer responsible for the roofing and flashing system, shall be used. The materials manufacturer is required to make periodic inspections of the work in progress to ensure that the completed work will qualify for the required warranties.

Roof deck insulation shall not be used as the only element in the overall building thermal resistance system. Refer to Section 07 21 00.

Shingle specifications should be similar to TAMKO Heritage.

Shingle roof repairs and modifications which are part of a renovation project (e.g. installation of a new exhaust fan) should follow these standards as much as possible. Existing roof warranties must not be compromised. The DP must prepare a complete specification and details for the required repair work. Generic "flashing as required" notes (which often appear on engineering details for new exhaust fans) are not acceptable.

Materials manufacturer(s) and installation contractor(s) must demonstrate 5 years of successful installations of exact systems or 5 jobs in Northern Arizona or comparable elevation and weather conditions (climate zone 5 over 5,000 feet elevation).

Underlayment for shingles will be 2 layers of wrinkle free underlayment, SBS modified asphalt, fiberglass reinforced, complying with ASTM D226, ASTM D146, ASTM D4601-97A, ASTM D4869-88, ASTM D2626-97, ASTM E96, ASTM E108 (for example, Liberty MA Base).

Preference is to substitute underlayment with full self-adhesive ice and water shield membrane when budget allows. Consult with Owner (Project Manager and NAU Roofing Supervisor) to determine best material to be used.

Metal trim and Flashing:

Where valley transitions occur, a 24 gauge sheet metal valley flashing shall be installed in accordance with industry standards on top of a 2-ply Styrene-Butadiene-Styrene (SBS) modified sheet. All perimeter eaves must incorporate a minimum of 2"x4", 24

Section
Number

Title

gauge sheet metal flashing. This also includes all rakes.

Metal Drip Edge: Brake-formed sheet metal with a four (4") inch roof deck flange and a four (4") inch fascia flange with a hemmed drip at lower edge. Furnish the material in lengths of 8 or 10 feet (2.5 to 3 m). Make certain face of metal fits firmly over edge, with proper three (3") inch lap at ends.

Metal Flashing: Job-cut to sizes and configuration required, dimensions given are for reference purposes, modify as needed.

Vent Pipe Flashing: Lead conforming to ASTM B 749, Type L51121, at least 4 lbs. lead, unless otherwise indicated. Provide lead sleeve sized extending at least four (4") inches (100 mm) from pipe onto roof. Completely solder all connections according to SMACNA standards.

All Metal Trim and Flashing shall be made of Galvanized-steel sheets.

SBS modified rubberized self-adhered ice shield shall be provided and installed at all eave perimeters and valleys and shall extend 6 feet up from eave edge and 3 feet up the wall.

Check with Owner if ice shield installation shall be required at all conditions.

Accessories:

Asphalt Plastic Cement: Non-asbestos fibrated asphalt cement, complying with ASTM D 4586.

Nails:

Are hot-dip galvanized steel, 0.120-inch (3 mm) diameter barbed shank, sharp-pointed, conventional roofing nails with a minimum d inch (9.5 mm) diameter head and of sufficient length to penetrate ¾ inch (19 mm) into solid decking or at least c inch (3 mm) through plywood sheathing.

Where nails are in contact with flashing, prevent corrosion action by providing nails made from the same metal as that of the flashing.

Face Nails/Fasteners for clad metal at tie into shingles will be of proper length to penetrate thru decking. Install fastener with grommet to help seal exposed fastener.

Specify (or detail) 3/4" plywood nailers at all parapet walls.

Specify penetration sealing system similar to "Chem-Curb" for all roof penetrations

Section
Number

Title

Require submittal of manufacturer's literature describing the system, and samples of proposed shingles.

Specify expanded warranties as follows:

- Manufacturer's standard form, without monetary limitation, in which manufacturer agrees to repair or replace components of shingled roofing system that fails.
- 2-year warranty from the installation contractor covering defects in installation
- 20-year warranty from the materials manufacturer including defects in materials and installation, and guaranteeing to maintain the system in a waterproof condition for the life of the warranty on a 40-year shingle.
- Full replacement value without proration
- Include all components of the roof assembly, from the deck up
- Include sealing of all perimeters, joints, and penetrations

Part 2 – Products

A minimum of 235# Architectural-type heavy duty fiberglass shingles are the preferred roofing material. The DP shall specify a material with a minimum 20-year warranty. The use of asbestos-containing materials is expressly prohibited.

All primary and secondary materials must be supplied by a single manufacturer, or approved by the primary materials manufacturer, to ensure single-point responsibility for the installation and warranty.

Specify a manufacturer's standard shingle roofing system as follows (in accordance with current building codes as adopted by Owner – see Division 1 for applicable code):

- UL Class A fire rating
- UL Class 110 wind uplift rating
- ASTM D 7158-06 Class H, Wind Resistance
- ASTM D 3161 Class F, Test at 110 MPH
- ASTM E108 Class A, Fire Resistance
- Underlayment, shingle, starter shingle
- Minimum 30-mil underlayment
- Peel and stick self adhered 15-mil ice shield

For example, a manufacturer that meets this specification is TAMKO Heritage.

Limit roof insulation to 2" thick. Insulations shall be specified which provide adequate load-bearing capacity at the 2" thickness.

Quality Assurance:

- Installer Certificates: Signed by roofing system manufacturer certifying that installer is approved, authorized, or licensed by manufacturer to install roofing

Section
Number

Title

system. The installer's certification for approved material must be in the state of Arizona.

- Installer Qualifications: A qualified firm with 5-years (minimum) documented experience installing similar shingles. Installer must be approved, authorized, or licensed by roofing system manufacturer to install manufacturer's product and that is eligible to receive manufacturer's warranty for the approved materials.
- Manufacturer Certificates: Signed by roofing manufacturer certifying that roofing system complies with requirements specified in Section 07 31 13, Part 2 Products, and roof system, as indicated in the construction documents, meets requirements for roof system warranty specified in Section 07 31 13, Part 1 – General.

Part 3 – Execution

A pre-installation conference is required after the substrates are complete, and including the Contractor, Design Professional, Owner, materials manufacturer, and installing subcontractor(s).

Shingle roofing is a finish material, not a staging platform for further construction work. Include the following provisions:

- A "temporary roof" is required if the Contractor is to "dry-in" the building to allow interior construction to begin or to provide a platform for further exterior construction
- If Contractor wants to dry-in, Contractor must do so only with a temporary roof
- Reference the National Roofing Contractor's Association (NRCA) requirements for temporary roofs, including "sacrificial" insulation on metal decks
- Phased roofing is prohibited
- Finished roofs are required to be protected with plywood sheets for any and all construction traffic, and all equipment moving be accomplished with rollers. Any damage to a finished roof prior to project Substantial Completion is Contractor's responsibility. Any damage caused to finished roof after Substantial Completion and prior to Final Completion will be assessed to determine responsibility.

A copy of the roofing system manufacturer's inspection report of completed roofing installation is required to be provided to Owner.

The roof is to be installed in accordance with the manufacturer's recommendations. Comply with manufacturer's instructions and recommendations but not less than those recommended by "The NRCA Steep Roofing Manual".

Section
Number

Title

Installation contractor shall be certified by manufacturer to enforce warranty in Arizona.

Refer to and describe the appropriate Sheet Metal and Air Conditioning Contractors National Association (SMACNA) details for each edge and penetration condition.

The following are prohibited:

- Pitch pans
- Guy wires fastened directly to the deck

Examine substrate for compliance with requirements for substrates, installation tolerances, and other conditions affecting performance of asphalt shingles. Do not proceed with installation until unsatisfactory conditions have been corrected.

Commencement of roof application over any section will denote acceptability by Contractor of any section's readiness to receive asphalt shingles and he will be responsible for any corrective work which may be occasioned by his having started over an unsatisfactory surface.

Clean substrate of projections and substances detrimental to application. Cover knotholes or other minor voids in substrate with sheet metal flashing secured with non corrosive roofing nails.

Coordinate installation with flashings and other adjoining work to ensure proper sequencing. Do not install roofing materials until all vent stacks and other penetrations through roof sheathing have been installed and are securely fastened against movement.

For re-roofing projects: Contractor shall remove all existing roofing, flashings, nails, etc. down to the existing roof deck. All tear-off materials shall be removed from the roof on a daily basis and disposed of in accordance with applicable codes and ordinances. Contractor shall not remove more in one day than can be covered the same day and made completely watertight.

Fasten asphalt shingles to roof sheathing by hand using nails (6 nails per shingle). Use of pneumatic/electric nail guns and/or staples is not acceptable.

Felt Underlayment: Apply two layers of felt underlayment horizontally over entire surface to receive asphalt shingles, lapping succeeding courses a minimum of two (2") inches (50 mm), end laps a minimum of four (4") inches (100 mm), and hips and valleys a minimum of six (6") inches (150 mm). Fasten felt with sufficient number of roofing nails to hold underlayment in place until asphalt shingle installation. Do not

Section
Number

Title

leave underlayment exposed to the elements for more than thirty (30) days.

Metal Open Valley: Comply with ARMA and NRCA recommendations. Install a second felt underlayment shingle lapped at least twelve (12") inches (300 mm). Install 2-ply modified sweat sheet and cover outside of valley metal with 2-ply dry-in.

Flashing: Install metal flashing and trim as indicated and according to details and recommendations of the "Asphalt Roofing" section of the "The NRCA Steep Roofing Manual". Require the roofing installer to receive, accept, and install, all sheet metal flashings.

Install asphalt shingles, beginning at roof's lower edge, with a starter shingle or strip of roll roofing. Fasten asphalt shingles in the desired weather exposure pattern; use number of fasteners per shingle (minimum of 6) as recommended by manufacturer. Use vertical and horizontal chalk lines to ensure straight coursing. Cut and fit asphalt shingles at valleys, ridges, and edges to provide maximum weather protection. Use fasteners at ridges of sufficient length to penetrate sheathing as specified.

Pattern: a shingle spacing offset at succeeding courses.

Repair or replace loading ground area when / if damaged back to original condition at minimum.

All roofing projects shall add the required permanent roof tie-off/anchor points installations to meet current OSHA standards for fall protection.

****END OF SECTION****

Section
Number

Title

07 40 00

ROOFING AND SIDING PANELS

Part 1 – General

Systems described in this Section are intended to be installed in situations where the roof slope is at least 2-1/2 inches per foot, and where the roofs are not intended to receive regular foot traffic for equipment maintenance.

Specify a complete roofing system, making the materials manufacturer responsible for the roofing and flashing system. Require the materials manufacturer to make periodic inspections of the work in progress to ensure that the completed work will qualify for the required warranties.

Do not use roof deck insulation as the only element in the overall building thermal resistance system. Refer to Specification Section 07 21 00.

Metal roof repairs and modifications which are part of a renovation project (e.g. installation of a new exhaust fan) shall follow these standards. Existing roof warranties must not be compromised. The DP shall prepare a complete specification and details for the required repair work. Generic "flashing as required" notes (which often appear on engineering details for new exhaust fans) are not acceptable.

Coordinate specification requirements with roofing, flashing, and parapet wall details.

Specify (or detail) 3/4" plywood nailers at all parapet walls.

The DP shall ensure that metal roof design addresses potential for excessive snow slides, icicle accumulation and falling area, particularly in the areas of entrances, emergency exits, loading docks, lower roof areas, landscaping and walk-ways. Require that materials manufacturer(s) and installer(s) demonstrate 5 years of successful installations of similar systems.

Require submittal of:

- Manufacturer's literature describing the system
- Shop drawings showing panel layout, and all edge, transition, and penetration details
- Samples of proposed metal panels

Specify expanded warranties as follows:

- 5-year warranty from the installer covering defects in installation
- 30-year warranty from the materials manufacturer including defects in materials and installation, hail damage, and guaranteeing to maintain the system in a waterproof condition for the life of the warranty
- Full replacement value without proration
- Include all components of the roof assembly, from the deck up

Section
Number

Title

- Include sealing of all perimeters, joints, and penetrations

Part 2 – Products

Require that all primary and secondary materials be supplied by a single manufacturer, or approved by the primary materials manufacturer, to ensure single-point responsibility for the installation and warranty.

Specify a manufacturer's standard preformed metal roofing system as follows:

- UL Class A fire rating
- UL wind uplift rating capable of resisting wind speeds up to 100 miles per hour
- Minimum 15-lb asphalt saturated underlayment
- Factory formed panels, steel, aluminum, or copper
- Concealed fastener installation
- Factory applied polyvinylidene fluoride finish, or natural metal finish intended for exposure to the elements

Limit roof insulation to 2" thick. Insulations which provide adequate load-bearing capacity shall be the 2" thickness.

Coordinate the design of tested roofing assemblies with the supporting roof structural system.

Minimum gauges:

- Roofs 22 ga
- Walls 18 ga

Minimum panel width 12"

Part 3 – Execution

A pre-installation conference is required after the substrates are complete, and must include the Contractor, Design Professional, Owner, materials manufacturer, and installing subcontractor(s).

Metal roofing is a finish material, not a staging platform for further construction work. Include the following provisions:

- A "temporary roof" is required if the Contractor is to "dry-in" the building to allow interior construction to begin or to provide a platform for further exterior construction
- If Contractor wants to dry-in, the Contractor must do so only with a temporary roof
- Reference the National Roofing Contractor's Association (NRCA) requirements for temporary roofs, including "sacrificial" insulation on metal decks

Section
Number

Title

- Phased roofing is prohibited
- Finished roofs are required to be protected with plywood sheets for any and all construction traffic, and all equipment moving be accomplished with rollers. Any damage to a finished roof prior to project Substantial Completion is Contractor's responsibility. Any damage caused to finished roof after Substantial Completion and prior to Final Completion will be assessed to determine responsibility.

When 6-inch rigid insulation is designed for the roof system, secondary purlin support framing shall be provided for pre-engineered systems.

The roof is to be installed in accordance with the manufacturer's recommendations.

Refer to and describe the appropriate SMACNA details for each edge and penetration condition.

The installation contractor shall receive, accept, and install, all sheet metal flashings.

The following are specifically prohibit:

- Pitch pans
- Guy wires fastened directly to the deck

A spray test is required after completion of the roofing system, to be witnessed by the Contractor, Design Professional, Owner, materials manufacturer, and installing contractor(s).

****END OF SECTION****

Section
Number

Title

07 50 00**MEMBRANE ROOFING**Part 1 – General

This section applies specifically to membrane roofs, but also pertains to other methods of roofing or those areas effectively acting as “roofs” (decks, overhangs, balconies, etc.). To aid in attaining both the written specification and warranties called for by Owner, the DP should design and detail appropriate roof slopes, drainage system(s), cants, flashing, protection devices or materials and utilize good common sense. Roofing techniques, systems and materials should be utilized that are “time proven” (+5 years) and be designed as “composite” systems instead of appliqués. Roofing shall be done only by an installation contractor who is approved by the manufacturer whose materials are used.

DP shall use online roofing system design tools to establish the values used to calculate the specified roof assembly’s resistance to fire, hail and wind. As an example, RoofNav by FM Approvals, LLC is an online roofing system design tool.

Specify primary products, including roofing sheets, as produced and supplied from a single manufacturer, which has produced that product successfully for not less than 5 years *without formulation change*.

A single installation contractor shall perform the work, and have not less than 5 years of successful experience in the installation of specified roofing systems. This criteria shall be verified prior to notice to proceed (NTP). Contractor must be licensed and certified by manufacturer in the State of Arizona.

Owner requires a 20 year No Dollar Limit warranty on all membrane roofing systems along with a 1 ½ inch hail rider warranty.

Owner requires all membrane roofing systems to resist the uplift forces produced by wind speeds up to 100 miles per hour. Coordinate the design of tested roofing assemblies with the supporting roof structural system.

Roofing systems should be designed and/or specified that will allow occasional foot traffic by maintenance personnel. In areas where there is more frequent foot traffic, additional *walk pads* or elevated pads should be designed and demarcated, as approved by the material manufacturer. TRAFBLOC is an example of this material.

DP shall specify protection of membrane roofing where falling icicle damage is possible.

Exterior insulation systems on top of membrane or built-up layers should be avoided

Section
Number

Title

due to the extreme difficulty in tracing and repairing roofing leaks.

All roofing projects shall add the required permanent roof tie-off/anchor points installations to meet current OSHA standards for fall protection.

Part 2 – Products

Refer to sections below for products requirements & recommendations

Part 3 – Execution

Refer to sections below for Execution requirements & recommendations

07 51 00 Built-Up Bituminous Roofing

Part 1 – General

BUR systems are no longer an approved system for Northern Arizona roofs.

Part 2 – Products

N/A

Part 3 – Execution

N/A

07 54 00 Thermoplastic Membrane Roofing

Part 1 – General

This Section includes the following:

- Mechanically fastened or fully adhered membrane roofing system.
- Coated Edge metal flashing materials.
- Insulation & Fire Barrier Board

PROJECT CONDITIONS

Weather Limitations: Proceed with installation only when existing and forecasted weather conditions permit roofing system to be installed according to manufacturer's written instructions and warranty requirements. Owner reserves the right to stop work at any time due to weather.

Any substrate to receive new insulation, membrane or flashing shall be thoroughly dry. Should surface moisture occur the Contractor shall provide adequate equipment to dry the substrate.

Prior to and during application, the Contractor shall ensure that all debris, dirt and dust shall be removed from surfaces where the new roofing is being installed.

Section
Number

Title

Precautions shall be taken to prevent wind blow-off or wind damage during the course of the roofing application. This may necessitate additional securing of temporary construction. Materials stored on the roof shall be secured at all times so that no flying debris may damage the installed roof system or surrounding areas.

PERFORMANCE REQUIREMENTS

Provide installed roofing membrane and base flashings that remain watertight; do not permit the passage of water; and resist specified uplift pressures, thermally induced movement, and exposure to weather without failure.

Material Compatibility: Provide roofing materials that are compatible with one another under conditions of service and application required, as demonstrated by roofing membrane manufacturer based on testing and field experience. *The materials shall meet ASTM 6754 or better.*

Roofing System Design: Provide a membrane roofing system that is identical to systems that have been successfully tested by a qualified testing and inspecting agency to resist the calculated uplift pressure produced by winds speeds of up to 100 miles per hour. *Membrane roofing system shall not be compiled of any asphalt materials.*

Fire-Test-Response Characteristics: Provide membrane roofing materials with the fire-test-response characteristics indicated as determined by testing identical products per test method below by UL or another testing and inspecting agency acceptable to authorities having jurisdiction. Materials shall be identified with appropriate markings of applicable testing and inspecting agency.

Exterior Fire-Test Exposure: Class A; ASTM E 108, for application and roof slopes indicated.

Provide UL Class A fire rating.

SUBMITTALS

Provide a list of 5 locations that the product has been installed at similar altitudes (over 5,000 feet) for the last 10 years or longer. *All products shall meet ASTM 6754 or better.*

Product Data: For each type of product indicated provide samples of all materials to be used that are part of the roofing system.

Shop Drawings: include plans, sections, details, and attachments to other Work, including:

Section
Number

Title

- Roof size
- Structural calculations identifying the wind uplift forces to be resisted by membrane roofing system and supporting structural system
- Location and type of penetrations
- Perimeter and penetration details
- Base flashings and membrane terminations.
- Underlayment board installation
- Layout details
- Framing plan and framing fastening patterns.
- Roof drain assemblies

All details provided shall have been accepted by an authorized manufacturer's representative.

Warranties: submit two copies of manufacturer's total system warranty, including special warranties specified in this Section.

Material Safety Data Sheets for all products submitted to Owner prior to starting work.

Contractor's quality control program for installation of entire single-ply roofing membrane system submitted to Owner prior to starting work.

Maintenance Data: For roofing system to include in maintenance manuals to uphold warranty.

Inspection Report: Copy of roofing system manufacturer's inspection report of completed roofing installation.

QUALITY ASSURANCE

Contractor's roofing applicator (installation contractor) shall be certified in writing by the manufacturer of the specified product as a licensed approved applicator *in the State of Arizona*. *Companies with manufacturer approval outside of the State of Arizona are not deemed in compliance with the NAU Technical Standards.*

All mentioned information below shall be supplied at preconstruction meeting prior to contract execution:

Installer Certificates: Signed by roofing system manufacturer certifying that Installer is approved, authorized, or licensed by manufacturer to install roofing system.

Installer Qualifications: A qualified firm with 5-years (minimum) documented experience installing the specified product. Installer must be approved, authorized, or

Section
Number

Title

licensed by roofing system manufacturer to install manufacturer's product and that is eligible to receive manufacturer's warranty for the approved materials.

Submit the following qualification data: Project Foreman or Superintendent shall have supervised a minimum of five (5) projects of similar size and scope as this Project with the specified product. Contractor shall provide Name and address of these five (5) projects of similar size and scope as this Project. Include contact name and phone number for reference.

Manufacturer Certificates: Signed by roofing manufacturer certifying that roofing system complies with requirements specified in Section 07 54 00 "Performance Specification" Article and roof system, as indicated in the construction documents, meets requirements for roof system warranty specified in "Warranty" Article.

Manufacturer Qualifications: The roofing membrane and system shall be identical to that used for this Project and which can show evidence of these materials being satisfactorily used on at least five (5) projects of similar size, scope and type within the last 5 years. Obtain components for membrane roofing system from or approved by roofing membrane manufacturer.

Pre-installation Conference

Conduct conference at Project site. Review methods and procedures related to roofing system including, but not limited to, the following:

Meet with Owner, Owner's representative, testing and inspecting agency representative, Contractor, roofing installation contractor, roofing system manufacturer's technical representative and all subcontractors directly related to the installation of the new roof system.

Review methods and procedures related to roofing installation, including manufacturer's written instructions. Note: Contractor shall have written manufacturer specifications, roof drawings, roof drawing notes, scope of work and specifications on site at all times during the construction period.

Items of discussion shall include warranty and submittal requirements.

Review and finalize construction schedule and verify availability of materials, Installer's personnel, equipment, and facilities needed to make progress and avoid delays. Review building protection, staging areas, site logistic plan, fall protection, installation procedures and requirements.

Review structural loading limitations of roof deck during and after roofing.

Review base flashings, special roofing details, roof drainage, roof penetrations, equipment curbs, and condition of other construction that will affect roofing system.

Review governing regulations and requirements for insurance and certificates if applicable.

Section
Number

Title

Review Contractor’s Risk Management Plan and OSHA approved Safety Program.

Review Contractor’s Quality Control program.

Review weather conditions.

Review roof observation and repair procedures after roofing installation.

DELIVERY, STORAGE, AND HANDLING

Deliver roofing materials to Project site in original containers with seals unbroken and labeled with manufacturer's name, product brand name and type, date of manufacture, and directions for storing and mixing with other components.

Membrane rolls shall be stored lying down on pallets and fully protected from the weather with clean canvas tarpaulins. Unvented polyethylene tarpaulins are not accepted due to the accumulation of moisture beneath them in certain weather conditions that may affect the ease of membrane weldability.

Store liquid materials in their original undamaged containers in a clean, dry, protected location and within the temperature range required by roofing system manufacturer. Protect stored liquid material from direct sunlight. All flammable materials shall be stored in a cool, dry area, away from sparks and flames.

Discard and legally dispose of liquid material that cannot be applied within its stated shelf life.

Protect roof insulation materials from physical damage and from deterioration by sunlight, moisture, soiling, and other sources. Store in a dry location. Comply with insulation manufacturer's written instructions for handling, storing, and protecting during installation.

Handle and store roofing materials and place equipment in a manner to avoid permanent deflection of deck.

WARRANTY

Special Warranty: Manufacturer's standard form, without monetary limitation (“No Dollar Limit” NDL warranty), in which manufacturer agrees to repair or replace components of membrane roofing system that fail in materials or workmanship within specified warranty period. Failure includes roof leaks.

Special warranty shall include all materials and installation from the structural deck up including, but not limited to, substrate board, expansion joints, roof insulation, roofing

Section
Number

Title

membrane, base flashings, roofing membrane accessories, fasteners, cover boards, walkway products and other components of membrane roofing system.

Warranty Period: 20 years from date of Substantial Completion.

Warranty shall include 1 ½” hail warranty and shall not include exclusions for ponding water.

Part 2 – Products

MANUFACTURERS

Products: Available Manufacturers: Subject to compliance with performance specifications.

Inter-ply Reinforcement to be reinforced polyester knit fabric coated with an adhesive coat to promote a molecular bond between the base fabric and the front and back coats.

Manufacturers: Subject to compliance with requirements, substitution request must in accordance with bid documents. Provide products by the manufacturers specified that meet or exceed stated manufacturer qualifications, performance requirements, fire test requirements, physical properties requirements and warranty requirements.

Owner has pre-approved the following manufacturers to be in compliance with these standards:

- Fibertite/Seaman Corporation 50XT *or approved equal*

PERFORMANCE SPECIFICATION

Thickness: 50 mils (1.1 mm), nominal. Manufactured in 56” X 100’

Color: Beige or White.

Inter-ply Reinforcement to be 18 x 21 / 1,100 x 1,100 denier weft reinforced polyester knit fabric coated with an adhesive coat to promote a molecular bond between the base fabric and the front and back coats.

Mil Thickness Substitution request must comply with the following Minimum Physical Properties:

PROPERTY	TEST METHOD	RESULTS
Thickness	ASTM D-751	.050 minimum
Tear Resistance	ASTM D-751	125 lbs x 50 lbs (8” x 10” sample)
Seam Strength	ASTM D-751	500 lbs
Breaking Strength	ASTM D-751	600 lbs

DIVISION 7 - THERMAL AND MOISTURE PROTECTION

Section
Number Title

Tensile Strength	ASTM D-882	9500 psi
Elongation		20% X 30%
Peel Strength		no peel
Scrim Size		18 X 18
Water Vapor Transition		1.3
Water Absorption		<5%
Dimensional Stability	ASTM D-1204	0.5%
Low Temperature Flexibility	ASTM D-2136	-40F
Puncture Resistance	Fed. Std. 101B	30 joules pass Method 2031
Hydrostatic Resistance	Mil-C-20696C	No swelling, cracking or leaking
Oil Resistance	Mil-C-20696C	No swelling, cracking or leaking
Coating Adhesion	ASTM D-751	Cannot initiate coating peel
Accelerated Weathering		Carbon Arc with 5,000 hours – no cracking, blistering or crazing.

AUXILIARY MATERIALS

General: Auxiliary materials recommended by roofing system manufacturer for intended use and compatible with membrane roofing.

Liquid-type auxiliary materials shall meet VOC limits of authorities having jurisdiction.

Sheet Flashing: Manufacturer's standard sheet flashing of same material, type, reinforcement, thickness, and color as sheet membrane.

Bonding Adhesive: Manufacturer's standard solvent-based bonding adhesive for membrane, and solvent-based bonding adhesive for base flashings.

Metal Termination Bars: Manufacturer's standard predrilled aluminum bars with anchors, approximately 1 by 1/8 inch thick; with anchors.

Metal Battens: Manufacturer's standard aluminum-zinc-alloy-coated or zinc-coated steel sheet, approximately 1 inch wide by 0.05 inch thick, pre-punched.

Fasteners: designed for fastening membrane to substrate, and acceptable to membrane roofing system manufacturer. Factory-coated steel fasteners and metal or plastic plates meeting corrosion-resistance provisions in FMG 4470, designed for fastening membrane to substrate, and acceptable to membrane roofing system manufacturer.

Miscellaneous Accessories: Provide pourable sealers, preformed cone and vent sheet flashings, preformed inside and outside corner sheet flashings, T-joint covers, termination reglets, cover strips, and other accessories.

Section
Number

Title

Laminated Metal Pre-Finished Coated Metal: Provide pre-finished, weldable coated metal as provided by the roofing system manufacturer, Gauge 24 galvanized steel laminated with polymeric coating.

Color: White

Wood Nailers: As required by roofing manufacturer

INSULATION & FIRE BARRIER BOARD

General: Provide preformed roof boards that comply with requirements and referenced standards, selected from manufacturer's standard sizes and of thicknesses indicated.

Fire Barrier Cover Board: ASTM C 1177, glass-mat, water-resistant gypsum substrate, 1/2" thick.

Product (mechanically attached surfaces): "Dens-Deck" by Georgia-Pacific Corporation (or approved equal). *Asphalt is not an approved adhesive.*

INSULATION ACCESSORIES

General: Roof insulation accessories recommended by insulation manufacturer for intended use and compatible with membrane roofing.

Fasteners: Factory-coated steel fasteners and metal or plastic plates meeting corrosion-resistance provisions in FMG 4470, designed for fastening roof insulation to substrate, and acceptable to roofing system manufacturer.

Part 3 – Execution

Examine substrates, areas, and conditions, with Installer present, for compliance with the following requirements and other conditions affecting performance of roofing system.

Verify that roof openings and penetrations are in place and set and braced.

Verify that wood blocking, curbs, and nailers are securely anchored to roof deck at penetrations and at terminations and verify that nailers match thicknesses of insulation.

Proceed with installation only after unsatisfactory conditions have been corrected.

MECHANICALLY FASTENED AND FULLY ADHERED ROOFING MEMBRANE INSTALLATION

Section
Number

Title

Install roofing membrane over area to receive roofing according to roofing system manufacturer's written instructions. Unroll roofing membrane and allow it to relax before installing it.

Start installation of roofing membrane in presence of roofing system manufacturer's technical personnel.

Accurately align roofing membranes and maintain uniform side and end laps of minimum dimensions required by manufacturer. Stagger end laps.

Mechanically fasten or fully adhered roofing membrane securely at terminations, penetrations, and perimeter of roofing.

Apply roofing membrane with side laps shingled with slope of roof deck where possible.

Seams: Clean seam areas, overlap roofing membrane, and hot-air weld side and end laps of roofing membrane according to manufacturer's written instructions to ensure a watertight seam installation.

Test lap edges with probe to verify seam weld continuity.

Apply lap sealant to seal cut edges of roofing membrane.

Verify field strength of seams a minimum of twice daily and repair seam sample areas. Repair tears, voids, and lapped seams in roofing membrane that does not meet requirements.

In-Splice Attachment: Secure one edge of roofing membrane using fastening plates or metal battens centered within membrane splice and mechanically fasten roofing membrane to roof deck. Field-splice seams.

BASE FLASHING INSTALLATION

Install sheet flashings and preformed flashing accessories and adhere to substrates according to membrane roofing system manufacturer's written instructions.

Apply solvent-based bonding adhesive to substrate and underside of sheet flashing at required rate and allow to partially dry. Do not apply bonding adhesive to seam area of flashing.

Flash penetrations and field-formed inside and outside corners with sheet flashing. Clean seam areas and overlap and firmly roll sheet flashings into the adhesive. Weld side and end laps to ensure a watertight seam installation.

Section
Number

Title

Terminate and seal top of sheet flashings and mechanically anchor to substrate through termination bars.

FIELD QUALITY ASSURANCE

Pre-Installation Conference: Contractor shall include in their bid, the cost for roofing system manufacturer’s technical personnel to attend the Pre-Installation Conference.

Final Roof Inspection: Contractor shall include in their bid, the cost for the roofing system manufacturer’s technical personnel to inspect roofing installation on completion and submit final inspection report to the Owner’s representative.

Notify Owner’s representative 48 hours in advance of date and time of inspection.

Repair or remove and replace components of membrane roofing system where test results or inspections indicate that they do not comply with specified requirements.

Additional testing and inspecting, at Contractor’s expense, will be performed to determine compliance of replaced or additional work with specified requirements.

PROTECTING AND CLEANING

Protect membrane roofing system from damage and wear during the remaining construction period so as not affect or endanger roofing, inspect roofing for deterioration and damage, describing its nature and extent in a written report, with copies to Owner.

Correct deficiencies in or remove membrane roofing system that does not comply with requirements, repair substrates, and repair or reinstall membrane roofing system to a condition free of damage and deterioration at time of Substantial Completion and according to warranty requirements.

Clean overspray and spillage from adjacent construction using cleaning agents and procedures recommended by manufacturer of affected construction.

****END OF SECTION****

Section
Number

Title

07 60 00

FLASHING AND SHEET METAL

Part 1 – General

No building design shall include uncapped parapets.
Parapet caps shall be metal, not masonry.

Part 2 – Products

N/A

Part 3 – Execution

N/A

****END OF SECTION****

Section
Number

Title

07 70 00 ROOF AND WALL SPECIALTIES AND ACCESSORIES

07 72 00 Roof Accessories

Part 1 – General

Roof Hatch

Roof access is to be through a full size door (3'-0" x 7'-0").

All roofs shall be accessible for maintenance purposes, regardless of presence of mechanical or electrical equipment on the roof. Annual maintenance includes cleaning downspout and gutters and NAU Roofing personnel should be able to accomplish such task without the help of a lift.

When a hatch is provided, it shall be a self-flashing hatch. Minimum dimensions shall be such that any piece of equipment located on the roof can be removed from the roof through the hatch. If no equipment on the roof, use a minimum 24" x 36" clear opening.

Fall prevention system shall be installed on the roof to allow for maintenance.

Ridge Vents: installed per construction documents

Scuppers, downspouts and overflow drains shall not be installed in such a manner as to allow the water to run down the face of the building wall or across sidewalks.

All roof curbs to be a minimum of 12 inches above finished roof membrane

Part 2 – Products

N/A

Part 3 – Execution

N/A

07 76 00 Roof Pavers

Part 1 – General

Roof pavers or reinforced single ply membrane material shall be installed to provide access from roof door /hatch to any pieces of equipment that will require access to perform maintenance.

Part 2 – Products

N/A

DIVISION 7 - THERMAL AND MOISTURE PROTECTION

Section
Number

Title

Part 3 – Execution

N/A

****END OF SECTION****

Section
Number

Title

07 80 00 FIRE AND SMOKE PROTECTION

07 82 00 Board Fireproofing

Part 1 – General

Indicate on the drawings the UL Listing Number and fire resistance rating which is required for each condition of structural fireproofing.

All materials manufacturer(s) and applicator(s) must demonstrate 5 years of successful installation of similar materials.

A submittal of manufacturer's literature describing all materials, and the specific systems is required.

Part 2 – Products

The use of asbestos containing materials is prohibited.

When re-fireproofing structural elements where asbestos-containing fireproofing has been abated by the Owner, only materials which are known to be compatible with asbestos encapsulates can be used.

Part 3 – Execution

Describe requirements for protection of completed fireproofing.

Describe specific requirements for repair of fireproofing in the event of damage.

When re-fireproofing structural elements where asbestos-containing fireproofing has been spot-abated by the Owner, specifically describe precautions which the Contractor must take to protect adjoining asbestos containing fireproofing which remains.

07 84 00 Firestopping

Part 1 - General

Only tested firestop systems shall be used in specific locations as follows:

- A. Penetrations for the passage of duct, cable, cable tray, conduit, piping, electrical busways and raceways through fire-rated vertical barriers (walls and partitions), horizontal barriers (floor/ceiling assemblies), and vertical service shaft walls and partitions.
- B. Safing slot gaps between edge of floor slabs and curtain walls.
- C. Openings between structurally separate sections of wall or floors.
- D. Gaps between the top of walls and ceilings or roof assemblies.

Section
Number

Title

- E. Expansion joints in walls and floors.
- F. Openings and penetrations in fire-rated partitions or walls containing fire doors.
- G. Openings around structural members which penetrate floors or walls.

RELATED WORK OF OTHER SECTIONS

Coordinate work of this section with work of other sections as required to properly execute the work and as necessary to maintain satisfactory progress of the work of other sections, including:

- 1. Cast-In-Place Concrete
- 2. Joint Sealers
- 3. Masonry Work
- 4. Lath and Plaster
- 5. Gypsum Drywall Systems
- 6. Sound, Vibration and Seismic Control
- 7. Fire Suppression and Supervisory Systems
- 8. Basic Mechanical Materials and Methods
- 9. Mechanical Insulation
- 10. Fire Protection
- 11. Plumbing
- 12. Basic Electrical Materials and Methods

THROUGH-PENETRATION UL CLASSIFICATION SYSTEM

Fire Stopping Systems UL Classification System

Construction Type of System - Penetrated Construction Identification

- 1. No Penetrating Items: F, W, C A, B, J, K, L 0001-0999
- 2. Metallic Pipes, Conduit or Tubing: F, W, C A, B, J, K, L 1001-1999
- 3. Nonmetallic Pipe, Conduit or Tubing: F, W, C A, B, J, K, L 2001-2999
- 4. Electric Cables: F, W, C A, B, J, K, L 3001-3999
- 5. Cable, Trays with Electric Cables: F, W, C A, B, J, K, L 4001-4999
- 6. Insulated Pipes: F, W, C A, B, J, K, L 5001-5999
- 7. Electrical Bussduct Penetrations: F, W, C A, B, J, K, L 6001-6999
- 8. Mechanical Ductwork Penetrations: F, W, C A, B, J, K, L 7001-7999
- 9. Multiple Penetrations through Common Openings: F, W, C A, B, J, K, L 8000-8999

Construction Penetration

- F - Floor penetration
- W - Wall penetration
- C - Either floor or wall penetration

Section
Number

Type of Construction

- A – Concrete floors equal to or less than 5-inches thick
- B – Concrete floors greater than 5-inches thick
- J – Concrete or masonry walls equal to or less than 8-inches thick
- K – Concrete or masonry walls greater than 8-inches thick
- L – Framed walls

JOINT UL CLASSIFICATION SYSTEM

Fire-Resistant Joint Systems UL Classification System

- Joint
- System
- Movement
- Capability Joint Width
- 1. Floor-to-Floor FF D 0000-0999
- 2. Wall-to-Wall WW D 0000-0999
- 3. Floor-to-Wall: FW D 0000-0999
- 4. Head of Wall: HW D 0000-0999

Movement Capability

- D=Dynamic Has movement capability
- S=Static which does not require movement capability

Joint Width

- 0000-0999 Less than or equal to 2"
- 1000-1999 Greater than 2" Less than or equal to 6"
- 2000-2999 Greater than 6" Less than or equal to 12"

QUALITY ASSURANCE

- A. Fire-Test-Response Characteristics: Provide through-penetration fire stop systems and fire- resistive joint systems that comply with specified requirements of tested systems.
- B. Fire stop System installation must meet requirements of ASTM E 814, UL 1479 or UL 2079 tested assemblies that provide a fire rating equal to that of construction being penetrated.
- C. Proposed fire stop materials and methods shall conform to applicable governing codes having local jurisdiction.
- D. Fire stop Systems do not reestablish the structural integrity of load bearing partitions/assemblies, or support live loads and traffic. Installer shall consult the structural engineer prior to penetrating any load bearing assembly.
- E. For those firestop applications that exist for which no qualified tested system is available through a manufacturer, an engineering judgment derived from similar qualified tested system designs or other tests will be submitted to

Section
Number

Title

Owner for review and approval prior to installation. Engineering judgment documents must follow requirements set forth by the International Firestop Council.

1. Contractors will be responsible to check with manufacturer to verify that manufacturer does not have a tested assembly for a given application prior to submission of any Engineering Judgment.

SUBMITTALS

- A. Submit Product Data: Manufacturer's specifications and technical data for each material including the composition and limitations, documentation of qualified tested firestop systems to be used, and manufacturer's installation instructions.
- B. Manufacturer's engineering judgment identification number and document details when no qualified tested system is available for an application. Engineering judgment must include both project name and contractor's name who will install firestop system as described in document.
- C. Submit material safety data sheets and certificates of compliance provided with product delivered to job-site.
- D. VOC Content Limitations: For firestop system products, submit documentation of conformance with LEED's low-emitting materials requirements.

INSTALLER QUALIFICATIONS

- A. Contractor shall be or engage an experienced installer who is certified, licensed, or otherwise qualified by the firestopping manufacturer as having been provided the necessary training to install manufacturer's products per specified requirements. A supplier's willingness to sell its firestopping products to the Contractor or to an installer engaged by the Contractor does not in itself confer qualification on the buyer.
- B. Installation Responsibility: assign installation of through-penetration firestop systems and fire-resistive joint systems in Project to a single source SPECIALTY FIRESTOP CONTRACTOR.
- C. The work is to be installed by a contractor with at least one of the following qualifications:
 1. UL Approved Contractor
 2. FM 4991 Approved Contractor
- D. Contractor shall have at least 3-years' experience with complete fire stop installations.
- E. Contractor shall have successfully completed 3 or more comparable scale projects using similar systems.

DELIVERY, STORAGE, AND HANDLING

- A. Deliver materials undamaged in manufacturer's clearly labeled, unopened

Section
Number

Title

- containers, identified with brand, type, and UL label where applicable.
- B. Coordinate delivery of materials with scheduled installation date to allow minimum storage time at job-site.
- C. Store materials under cover and protect from weather and damage in compliance with manufacturer's requirements, including temperature restrictions.
- D. Comply with recommended procedures, precautions or remedies described in material data safety sheets as applicable.
- E. Do not use damaged or expired materials.

PROJECT CONDITIONS

- A. Do not use materials that contain flammable solvents.
- B. Schedule installation of firestopping after completion of penetrating item installation but prior to covering or concealing of openings.
- C. Verify existing conditions and substrates before starting work and correct unsatisfactory conditions before proceeding.
- D. Weather conditions: Do not proceed with installation of firestop materials when temperatures exceed the manufacturer's recommended limitations for installation printed on product label and product data sheet.
- E. During installation, provide masking and drop cloths to prevent firestopping materials from contaminating any adjacent surfaces.

Part 2 – Products

FIRESTOPPING, GENERAL

- A. Provide firestopping composed of components that are compatible with each other, the substrates forming openings, and the items, if any, penetrating the firestopping under conditions of service and application, as demonstrated by the firestopping manufacturer based on testing and field experience.
 - 1. The use of multiple manufacturers' materials within the context of the same opening voids all warranties and will not be accepted.
- B. Provide components for each firestopping system that are needed to install fill material. Use only components specified by the firestopping manufacturer and approved by the qualified testing agency for the designated fire-resistance-rated systems.
- C. Firestopping Materials are either "cast-in-place" (integral with concrete placement) or "post installed." Provide cast-in-place firestop devices prior to concrete placement.
- D. Seal all openings or voids made by penetrations to ensure an air and water resistant seal.

DIVISION 7 - THERMAL AND MOISTURE PROTECTION

Section Number	Title
E.	Consult with DP, Owner, and damper manufacturer prior to installation of through-penetration firestop systems that might hamper the performance of fire dampers as it pertains to duct work.
F.	Protect materials from damage on surfaces subjected to traffic.
G.	Apply a suitable bond-breaker to prevent three-sided adhesion in applications where this condition might occur such as the intersection of a gypsum wallboard/steel stud wall to floor or roof assembly where the joint is backed by a steel ceiling runner or track.
H.	Where joint application is exposed to the elements, fire-resistive joint sealant must be approved by manufacturer for use in exterior applications and shall comply with ASTM C-920, "Specification for Elastomeric Joint Sealants".

MANUFACTURERS

- A. Manufacturers are subject to compliance with through penetration firestop systems (XHEZ), joint systems (XHBN), and perimeter firestop systems (XH DG) listed in Volume 2 of the UL Fire Resistance Directory.
- B. Owner has pre-approved the following manufacturers to be in compliance with these standards:
 - a. Specified Technologies Inc. STI Somerville, New Jersey
800.992.1180/www.stifirestop.com
 - b. Hilti, Inc., Tulsa, Oklahoma 800-879-8000/www.us.hilti.com
 - c. Approved equal, as approved in writing from Owner

PERFORMANCE REQUIREMENTS

- A. Provide products that upon curing do not re-emulsify, dissolve, leach, breakdown or otherwise deteriorate over time from exposure to atmospheric moisture, sweating pipes, ponding water or other forms of moisture characteristic during and after construction.
- B. Provide firestop sealants sufficiently flexible to accommodate motion such as pipe vibration, water hammer, thermal expansion and other normal building movement without damage to the seal.
- C. Pipe insulation shall not be removed, cut away or otherwise interrupted through wall or floor openings. Provide products appropriately tested for the thickness and type of insulation utilized.
- D. Fire rated pathway devices shall be the preferred product and shall be installed in all locations where frequent cable moves, add-ons and changes will occur.
- E. When mechanical cable pathways are not practical, openings within walls and floors designed to accommodate voice, data and video cabling shall be provided with re-enterable products specifically designed for retrofit.
- F. Penetrants passing through fire-resistance rated floor-ceiling assemblies contained within chase wall assemblies shall be protected with products tested by being fully exposed to the fire outside of the chase wall. Systems within the

Section
Number

Title

UL Fire Resistance Directory that meet this criterion are identified with the words "Chase Wall Optional".

- G. Provide fire-resistive joint sealants sufficiently flexible to accommodate movement such as thermal expansion and other normal building movement without damage to the seal.
- H. Provide fire-resistive joint sealants designed to accommodate a specific range of movement and tested for this purpose in accordance with acyclic movement test criteria as outlined in Standards, ASTM E-1399, ASTM E-1966 or ANSI/ UL 2079.
- I. Provide through-penetration firestop systems and fire-resistive joint systems subjected to an air leakage test conducted in accordance with the Standards, ANSI/ UL1479 for penetration and ANSI/UL2079 for joint systems, with published L-Ratings for ambient and elevated temperatures as evidence of the ability of the firestop system to restrict the movement of smoke.
- J. Provide T-Rating Collar Devices tested in accordance with ASTM E-814 or ANSI/UL1479 for metallic pipe penetrations requiring T-Ratings per the applicable building code.

MATERIALS

- A. Use only firestop products that have been UL 1479, ASTM E 814 or UL 2079, ASTM E 1966 tested for specific fire-rated construction conditions conforming to construction assembly type, penetrating item type, annular space requirements, and fire-rating involved for each separate instance.
- B. Pre-installed firestop devices for use with noncombustible and/or combustible pipes (closed and open systems), conduit, and/or cable bundles penetrating concrete floors.
- C. Owner has pre-approved the following products to be in compliance with these standards:
 - 1. STI Cast-In Place Devices
 - a. CD200, CD300, CD400, CD600 Cast-In Place for combustible OR non-combustible penetrants, or CD200M, CD300M, CD400M, CD600M Cast-In Place for non-combustible penetrants
 - b. Add metal deck adapter kit/s CD200DK, CD300DK, CD400DK, CD600DK on any corrugated metal deck to bridge flutes
 - c. Add height adapter CD200X, CD300X, CD400X, CD600X for concrete slabs which exceed 8" overall thickness
 - d. Add tub box kit CD200T for use with tub installations
 - 2. Hilti CP 680P or CP 680M Cast-In Place Firestop Devices:
 - a. Add Aerator adapter when used in conjunction with an Aerator (Sovent system)
 - b. Add metal deck adapter kit if utilizing CP 680P or M on corrugated metal deck.

Section
Number

Title

- c. Add height extension if utilizing CP 680P or M in concrete slabs thicker than 8".
 - d. Add Hilti Water Module (2" up to 6") to achieve UL W-Rating
 - e. Add Hilti TOP SEAL (1/2" up to 2") to achieve UL W-Rating
 - 3. Hilti CP 681 Tub Box Kit for use with bath tub installations.
 - 4. Hilti Toilet Flange for use with floor outlet water closets.
 - 5. Hilti coupling sleeve for use with floor, shower or general purposes drains
- C. Fire rated cable pathway devices shall be used for ALL low-voltage, video, data and voice cabling, optical fiber raceways and certain high-voltage cabling where frequent cable moves, adds and changes may occur. Pathways required for high voltage cabling will be detailed on the prints. Such devices shall:
- 1. Meet the hourly fire-rating of fire rated wall and or floor penetrated.
 - 2. Be tested for the surrounding construction and cable types involved.
 - 3. Have UL Systems permitting cable loads from; *"Zero to 100% Visual Fill."* This requirement eliminates need for fill-ratio calculations to be made by cable technicians to ensure cable load is within maximum allowed by UL System.
 - 4. Not have inner fabric liner that tightens around and compresses cables tightly together encouraging alien cross-talk interference.
 - 5. Be *"Zero-Maintenance"*, zero-maintenance is defined as; No action required by cabling technician to open and/or close pathway for cable moves, adds or changes, such as, but not limited to:
 - a. Opening or closing of doors.
 - b. Spinning rings to open or close fabric liner.
 - c. Removal and or replacement of any material such as, but not limited to, firestop caulk, putty, pillows, bags, foam muffins, foam, foam plugs, foam blocks, or foam closures of any sort.
 - d. Furnish letter from manufacturer certifying compliance with this definition of *"Zero-Maintenance"*.
 - 6. Pathways shall be engineered such that two or more devices may be ganged together for larger cable capacities.
 - 7. Pathways shall be engineered to be re-enterable so they can be retrofitted and removed from around existing cables without cutting and re-splicing them.
 - 8. Cable Pathway Devices passing vertically through floors shall have equal F & T Rating. (See UL System # F-A-3037, Item #4 *"EZ-PATH Grid T-Rating Kit"* Part # TRK444)
 - 9. Affix adhesive wall label immediately adjacent to devices to communicate to future cable technicians, authorities having jurisdiction and others the manufacturer of the device and the corresponding UL System number installed.

DIVISION 7 - THERMAL AND MOISTURE PROTECTION

Section
Number

Title

- D. As an alternate to using a fire-rated cable pathway device for single low voltage cables (up to 0.27 in. (7 mm) O.D) penetrating one or two-hour, gypsum board/stud wall assemblies, either as a through-penetration or as a membrane-penetration, a fire-rated cable grommet may be substituted. The firestop shall consist of a molded, two-piece, plenum-rated grommet having a foam fire and smoke sealing membrane that conforms to the outside diameter of the individual cable. The grommet product shall be capable of locking into place to secure the cable penetration within the wall assembly. The grommet shall be UL Classified and tested to the requirements of ASTM E814 (UL1479) and CAN/ULC S115.
- E. Sealants, caulking materials, or foams for use with non-combustible items including steel pipe, copper pipe, rigid steel conduit and electrical metallic tubing (EMT). Owner has pre-approved the following products to be in compliance with these standards:
1. STI Triple S Intumescent Firestop Sealant
 2. STI LCI Intumescent Firestop Sealant
 3. STI LC Endothermic Firestop Sealant
 4. STI AS Elastomeric Firestop Spray
 5. STI PEN or PENSL Silicone Firestop Sealant
 6. Hilti FS-ONE Intumescent Firestop Sealant
 7. Hilti CP 604 Self-leveling Firestop Sealant
 8. Hilti CP 620 Fire Foam
 9. Hilti CP 606 Flexible Firestop Sealant
 10. Hilti CP 601S Elastomeric Firestop Sealant
- F. Sealants or caulking materials for use with sheet metal ducts. Owner has pre-approved the following products to be in compliance with these standards:
1. STI Triple S Intumescent Firestop Sealant
 2. STI LCI Intumescent Firestop Sealant
 3. STI LC Endothermic Firestop Sealant
 4. STI AS Elastomeric Firestop Spray
 5. STI PEN or PENSL Silicone Firestop Sealant
 6. Hilti CP 601S Elastomeric Firestop Sealant
 7. Hilti CP 606 Flexible Firestop Sealant
 8. Hilti FS-ONE Intumescent Firestop Sealant
- G. Sealants, caulking or spray materials for use with fire-rated construction joints and other gaps. Owner has pre-approved the following products to be in compliance with these standards:
1. STI AS Elastomeric Firestop Spray

DIVISION 7 - THERMAL AND MOISTURE PROTECTION

Section
Number

Title

2. STI Fast Tack Firestop Spray
3. STI ES Elastomeric Firestop Sealant
4. STI LC Endothermic Firestop Sealant
5. STI Speed Flex Joint Solution System
6. STI PEN or PENSL Silicone Firestop Sealant
7. Hilti CP 672 Speed Spray
8. Hilti CP 672 FC "FAST CURE" Speed Spray
9. Hilti CP 601 S Elastomeric Firestop Sealant
10. Hilti CP 606 Flexible Firestop Sealant
11. Hilti CP 604 Self-leveling Firestop Sealant

H. Pre-formed mineral wool designed to fit flutes of metal profile deck and gap between top of wall and metal profile deck; as a backer for spray material. Owner has pre-approved the following products to be in compliance with these standards:

1. Hilti CP 777 Speed Plugs
2. Hilti CP 767 Speed Strips
3. Any manufacturer who can provide a 4PCF or greater mineral wool such as Thermafiber, Roxul etc. tested to all applicable standards

I. Intumescent sealants, caulking materials for use with combustible items (penetrants consumed by high heat and flame) including insulated metal pipe, PVC jacketed, flexible cable or cable bundles and plastic pipe. Owner has pre-approved the following products to be in compliance with these standards:

1. STI Triple S Intumescent Firestop Sealant
2. STI LCI Intumescent Firestop Sealant
3. Hilti FS-ONE Intumescent Firestop Sealant

J. Foams, intumescent sealants, or caulking materials for use with flexible cable or cable bundles. Owner has pre-approved the following products to be in compliance with these standards:

1. STI Triple S Intumescent Firestop Sealant
2. STI LCI Intumescent Firestop Sealant
3. STI SSP Intumescent Firestop Putty
4. STI CS105 Cable Spray
5. STI FS Ready Sleeve or FSR Split Sleeve Pathway Devices
6. Hilti FS-ONE Intumescent Firestop Sealant
7. Hilti CP 620 Fire Foam
8. Hilti CP 601S Elastomeric Firestop Sealant

DIVISION 7 - THERMAL AND MOISTURE PROTECTION

Section Number	Title
9.	Hilti CP 606 Flexible Firestop Sealant
K.	Non-curing, re-penetrable intumescent putty or foam materials for use with flexible cable or cable bundles. Owner has pre-approved the following products to be in compliance with these standards: <ol style="list-style-type: none">1. STI SSP Intumescent Firestop Putty2. STI FP200, FP400 Intumescent Firestop Plug3. STI SSB Intumescent Firestop Pillows4. STI FS Ready Sleeve or FSR Split Sleeve Pathway Devices5. Hilti CP 618 Firestop Putty Stick6. Hilti CP 658T Firestop Plug
L.	Wall opening protective materials for use with U.L. listed metallic and specified nonmetallic outlet boxes. Owner has pre-approved the following products to be in compliance with these standards: <ol style="list-style-type: none">1. STI SSP4S or SSP9S Intumescent Putty Pad2. STI EP44 or EP45 Intumescent Box Insert3. Hilti CP 617 Firestop Putty Pad4. Hilti Firestop Box Insert5. Hilti FS 657 FIRE BLOCK
M.	Firestop collar or wrap devices attached to assembly around combustible plastic pipe (closed and open piping systems). Owner has pre-approved the following products to be in compliance with these standards: <ol style="list-style-type: none">1. STI LCCIntumescent Firestop Collars2. STI RTC Intumescent Range Taking Collars3. STI SSWRED or SSWBLU Intumescent Wrap Strips4. Hilti CP 643 N Firestop Collar5. Hilti CP 644 Firestop Collar6. Hilti CP 648E Endless Wrap Strips7. Hilti CP 648S Single Wrap Strips
N.	Materials used for large openings and complex penetrations made to accommodate cable trays and bundles, multiple steel and copper pipes, electrical busways in raceways. Owner has pre-approved the following products to be in compliance with these standards: <ol style="list-style-type: none">1. STI SSM Firestop Mortar2. STI SSB Intumescent Firestop Pillows

DIVISION 7 - THERMAL AND MOISTURE PROTECTION

Section
Number

Title

3. STI CS Intumescent Composite Sheet
 4. STI Triple S Intumescent Firestop Sealant
 5. STI LCI Intumescent Firestop Sealant
 6. Hilti CP 637 Firestop Mortar
 7. Hilti FS 657 FIRE BLOCK
 8. Hilti CP 620 Fire Foam
 9. Hilti CP 675T Firestop Board
- O. Non-curing, re-penetrable materials used for large size/complex penetrations made to accommodate cable trays and bundles, multiple steel and copper pipes, electrical busways in raceways. Owner has pre-approved the following products to be in compliance with these standards:
1. STI SSB Intumescent Firestop Pillows
 2. STI CS Intumescent Composite Sheet
 3. Hilti FS 657 FIRE BLOCK
 4. Hilti CP 675T Firestop Board
- P. Sealants or caulking materials used for openings between structurally separate sections of wall and floors. Owner has pre-approved the following products to be in compliance with these standards:
1. STI AS Elastomeric Firestop Spray
 2. STI ES Elastomeric Firestop Sealant.
 3. STI LC Endothermic Firestop Sealant
 4. STI Fast Tack Silicone Firestop Spray
 5. STI PEN or PENSL Silicone Firestop Sealant
 6. Hilti CP 672 Speed Spray
 7. Hilti CP 601S Elastomeric Firestop Sealant
 8. Hilti CP 606 Flexible Firestop Sealant
 9. Hilti CP 604 Self-Leveling Firestop Sealant
- Q. For blank openings made in fire-rated wall or floor assemblies, where future penetration of pipes, conduits, or cables is expected. Owner has pre-approved the following products to be in compliance with these standards:
1. STI SSP Intumescent Firestop Putty
 2. STI FS Ready Sleeve or FSR Split Sleeve Pathway Device
 3. STI FP Intumescent Firestop Plug
 4. STI SSB Intumescent Firestop Pillow
 5. Hilti FS 657 FIRE BLOCK
 6. Hilti CP 658T Firestop Plug

Section Number	Title
R.	Provide a firestop system with a "F" Rating as determined by UL 1479 or ASTM E814 which is equal to the time rating of construction being penetrated.
S.	Provide a firestop system with an Assembly Rating as determined by UL 2079 or ASTM E 1966 which is equal to the time rating of construction joint assembly.
T.	Provide a firestop system with a "T" Rating where applicable as determined by UL 1479 or ASTM E814 which is equal to the "F" Rating of construction being penetrated. Please note "T" Ratings are not required in walls or when a penetration through the floor exists within a wall cavity.

Part 3 – Execution

PREPARATION

- A. Verification of Conditions: Examine areas and conditions under which work is to be performed and identify conditions detrimental to proper or timely completion.
 - 1. Verify penetrations are properly sized and in suitable condition for application of materials.
 - 2. Surfaces to which firestop materials will be applied shall be free of dirt, grease, oil, rust, laitance, release agents, water repellents, and any other substances that may affect proper adhesion.
- B. Provide masking and temporary covering to prevent soiling of adjacent surfaces by firestopping materials.
- C. Comply with manufacturer's recommendations for temperature and humidity conditions before, during and after installation of firestopping.
- D. Do not proceed until unsatisfactory conditions have been corrected.

COORDINATION

- A. Coordinate construction of openings, penetrations and construction joints to ensure that the fire stop systems are installed according to specified requirements.
- B. Coordinate sizing of sleeves, openings, core-drilled holes, or cut openings to accommodate through-penetration fire stop systems. Coordinate construction and sizing of joints to ensure that fire-resistive joint systems are installed according to specified requirements.
- C. Coordinate fire stopping with other trades so that obstructions are not placed in the way prior to the installation of the fire stop systems.
- D. Do not cover up through-penetration fire stop and joint system installations that will become concealed behind other construction until each installation

Section
Number

Title

has been examined by the building inspector, per requirements of IBC.

INSTALLATION

- A. Regulatory Requirements: Install firestop materials in accordance with UL Fire Resistance Directory or Omega Point Laboratories Directory.
- B. Comply with manufacturer's instructions for installation of through penetration and construction joint materials.
 - 1. Seal all holes or voids made by penetrations to ensure an air and water resistant seal.
 - 2. Consult with DP, Owner, and damper manufacturer prior to installation of UL firestop systems that might hamper the performance of fire dampers as it pertains to duct work.
 - 3. Protect materials from damage on surfaces subjected to traffic.

FIELD QUALITY CONTROL

- A. Examine sealed penetration areas to ensure proper installation before concealing or enclosing areas.
- B. Keep areas of work accessible until inspection by Owner.
- C. Inspection of through-penetration firestopping shall be performed in accordance with ASTM E 2174, "Standard Practice for On-Site Inspection of Installed Fire Stops" or other recognized standard.
- D. Perform under this section patching and repairing of firestopping caused by cutting or penetrating of existing firestop systems already installed by other trades.
- E. Manufacturer's Field Services: During installation, provide periodic destructive testing inspections to assure proper installation/application. After installation is complete, submit findings in writing indicating whether or not the installation of the tested system identified was installed correctly.

IDENTIFICATION & DOCUMENTATION

- A. Contractor by way of the firestop contractor is to supply documentation for each single application addressed. This documentation is to identify each penetration and joint location on the entire project.
- B. Copies of these documents are to be provided to the Owner at the completion of the project.
- C. Identify through-penetration firestop systems with self-adhesive, preprinted labels. Attach labels permanently to surfaces of penetrated construction on both sides of each firestop system installation where labels will be visible to anyone seeking to remove penetrating items or firestop systems. Include the following information on labels:
 - 1. Installer/Contractor's Name, address, and phone number.
 - 2. Through-Penetration firestop system designation of applicable testing

Section
Number

Title

- and inspecting agency.
- 3. Date of Installation.
- 4. Through-Penetration firestop system manufacturer's name.
- D. Firestop systems must not be concealed from view before being inspected and approved.
- E. Walk through visual inspections should be made during the firestop installation.
- F. When necessary or required, destructive evaluation will be made on various types of firestop systems.
- G. Construction documents detailing the firestop locations and systems must be kept on site to assist in the conduct of the inspection.
- H. Certificate of installation shall be provided from the installing contractor.

ADJUSTING AND CLEANING

- A. Remove equipment, materials and debris, leaving area in undamaged, clean condition.
- B. Clean all surfaces adjacent to sealed holes and joints to be free of excess firestop materials and soiling as work progresses.

LABOR USE TO INSTALL FIRESTOP SYSTEMS

- A. To ensure complete harmony on the project site, the installation of each scope of work is to be performed jurisdictionally correct per existing trade agreements.

07 84 13

Penetration Firestopping

Part 1 – General

Describe in this section all requirements for firestopping wall penetrations, floor penetrations, ceiling penetrations, and joints. Do not rely on general references in the sealants section. This includes boards, blankets, modules, pillows, tapes, caulks, foams, intumescent, and other similar materials.

Specifically describe on the drawings all requirements for installation of firestopping. Generic notes such as "firestopping as required" are not acceptable. Reliance on the Contractor understanding the building code and "complying at no additional cost" is similarly not acceptable.

Require that materials manufacturer(s) and installer(s) demonstrate 5 years of successful installations of similar materials.

Require submittal of complete manufacturer's literature, including UL test results for each material-and application system required for the project.

It is desirable to have all trades use the same product.

Section
Number

Part 2 – Products

Specify each type of firestopping material required in the project. Product shall be trowallable and paintable.

Part 3 – Execution

Provide a schedule identifying location and type of firestopping. Require installation of sleeves at all wall, floor, and ceiling penetrations.

Firestopping materials are to be installed in accordance with the manufacturer's recommendations.

All firestopping must be inspected as complete prior to being covered by other work.

****END OF SECTION****

DIVISION 7 - THERMAL AND MOISTURE PROTECTION

Section
Number Title

Section
Number

Title

07 90 00

JOINT PROTECTION

07 92 00

Sealants and Caulking

Part 1 – General

Sealants and Caulking shall not be more than $\frac{3}{4}$ " in width.

Describe all requirements for installation of sealants required to prohibit the penetration of moisture and dust, and required to seal joints between dissimilar materials, in this Section.

Specify certain specialized sealants which are ordinarily part of a "complete in place" installation by a particular trade (e.g. glazing sealants and painting) in the appropriate sections.

Reliance on caulking which might (or might not) be provided by a painter as part of that finish operation, as the moisture- or dust-seal, is unacceptable.

Specifically describe and detail on the drawings all joints requiring installation of sealants. Generic notes such as "sealant as required" are not acceptable.

Require that all materials manufacturer(s) and installer(s) demonstrate 5 years of successful installations of similar materials.

Require submittal of the following:

- Manufacturer's literature documenting compliance with specification requirements
- Actual sealant samples for color selection
- Sample joints, where unique conditions require

Maximum allowable exterior joint width, for caulking/sealant, shall not exceed 1".

Part 2 – Products

Specify each particular type of sealant and sealant system required, including:

- Primers
- Backers
- Fillers
- Colors

The use of latex and butyl sealants is prohibited

Specify only non-staining materials.

Part 3 – Execution

DIVISION 7 - THERMAL AND MOISTURE PROTECTION

Section
Number

Title

Provide a sealant schedule identifying location and type of sealant.

Specifically require sealants to be installed in accordance with the manufacturer's recommendations.

Specifically require all joints to be observed by the Owner prior to installation of sealants.

****END OF SECTION****

DIVISION 8 – OPENINGS

Section Number	Title
08 00 00	OPENINGS
08 10 00	DOORS AND FRAMES
08 11 00	Metal Doors and Frames
08 11 13	Hollow Metal Doors and Frames
08 11 19	Stainless-Steel Doors and Frames
08 14 00	Wood Doors
08 17 00	Integrated Door Opening Assemblies
08 40 00	ENTRANCES, STOREFRONTS, AND CURTAIN WALLS
08 41 00	Entrances and Storefronts
08 41 13	Aluminum-Framed Entrances and Storefronts
08 41 23	Steel-Framed Entrances and Storefronts
08 42 00	Entrances
08 42 29	Automatic Entrances
08 44 00	Curtain Wall and Glazed Assemblies
08 50 00	WINDOWS
08 51 00	Metal Windows
08 52 00	Wood Windows
08 52 16	Plastic-Clad Wood Windows
08 70 00	HARDWARE
08 80 00	GLAZING
08 81 00	Glass Glazing

DIVISION 8 – OPENINGS

Section Number	Title
08 00 00	OPENINGS

Part 1 - General

Doors and door hardware are to be installed only by qualified persons and all work must meet codes referenced in Division 1. No exceptions will be made to the hardware listed below for use in any construction without prior testing, evaluation and approval by appropriate departments within Owner's Facility Services department (FS).

Part 2 – Products

All doors, hardware, openers, etc. shall be specified as institutional grade throughout.

All hardware submittals shall be routed through Owner's Building Access Services department for review and approval prior to purchase.

Part 3 – Execution

Final acceptance of any hardware installations shall be subject to approval by Owner's Building Access Services department.

DIVISION 8 – OPENINGS

Section Number	Title
08 10 00	DOORS AND FRAMES
08 11 00	Metal Doors and Frames
08 11 13	Hollow Metal Doors and Frames <u>Part 1 - General</u> This section applies to both interior and exterior applications. In general, hollow metal doors should be designed and specified for areas of heavy use and potential abuse. Commercial heavy duty hollow metal frames should be utilized regardless of whether the door be hollow metal, glass, or wood. <u>Part 2 – Products</u> N/A <u>Part 3 - Execution</u>
08 11 19	Stainless-Steel Doors and Frames <u>Part 1 - General</u> Doors and frames shall be commercial heavy duty quality. Minimum door thickness shall be 1-3/4" thick. Interior doors shall comply with SD1-100, Grade II, heavy duty, minimum 16 gauge faces. Exterior doors shall comply with SD1-100 Grade III extra heavy duty, minimum 16 gauge faces. All exterior doors shall have thresholds, closures, weatherstripping, and padded stops. Designs calling for exterior glazed openings in steel doors shall use 1" insulated wire glass. Openings shall be limited to less than 60% glass area (code permitting). At least one section of an exterior door assembly (main ingress and egress) shall have an electric automatic door opener, button activated on both sides, interior and exterior Kickplates are required of all doors that are subject to high traffic. <u>Part 2 - Products</u> <u>Door Frames</u> In new construction all frames shall be welded. Knock-downs may be acceptable in building renovation work, pending Owner's Building Access Services approval of submittals and final installation. An inspection of anchoring must be made prior to drywall or closing up of walls. Frames shall have wall anchors a maximum of 16" o.c. per jamb. All door frames

DIVISION 8 – OPENINGS

**Section
Number**

Title

will be steel. Exterior door frames will be 14 gauge and protected from rust, internal frames may also be 14-gauge steel.

Door frames shall be factory pre-assembled with mitered fully welded joints ground smooth and delivered to the job site with spreaders. If knock-down and two-piece frames are unavoidable and approved in advanced by Owner's Building Access Services, it must have quality standards for securing and finishing these frames. Shop priming is required.

All frames shall be delivered prior to masonry construction. All frames in masonry walls shall be grouted full with Portland cement grout. Gypsum grout is not permitted.

There shall be seamless end channel closure pieces at door heads.

Doors

All external doors will be 16-gauge steel with vertical steel rib stiffeners and reinforced for all door hardware. Internal doors shall be 16-gauge, or may be solid core wood.

Where doors are to be used as part of an acoustical barrier assembly, they shall be rated a minimum of STC 33.

Doors used as a normal means of ingress and egress shall have either vision panels or adjacent sidelights (where allowable by fire ratings).

Doors shall have a minimum of 3 heavy duty industrial type hinges per door.

Doors and frames shall have a spray applied finish.

There shall be door stops on all installations and closures if doors open into a rated space.

Part 3 – Execution

N/A

08 14 00

Wood Doors

Part 1 - General

This section applies to interior applications. Endangered or limited tree species are not allowable for wood door veneers. Doors receiving painted finishes are

DIVISION 8 – OPENINGS

**Section
Number**

Title

limited to low cost species (birch, maple, etc.). Welded hollow metal frames should be utilized.

Part 2 - Products

Wooden doors are acceptable only for interior usage, must be solid core, and have adhesives that are 100% waterproof. Hollow core doors shall not be used and existing hollow core doors shall not be re-used.

All doors shall be solid core flush with veneer faces, commercial heavy duty minimum grade, 1-3/4" thick. Minimum width to be 3'-0". Maximum height to be 7'-0". **3'0" x 7'0" doors are the Owner's standard. Exceptions must be reviewed and approved by Owner's Building Access Systems. Specified requirements for non-standard doors are available through Owner's Carpentry department if approval is granted.**

Doors for renovation work shall be drilled to match existing handle-set elevations.

All doors should be from a single manufacturer.

Formaldehyde off-gassing rates must be less than .03 milligrams per square foot of surface/hr in accordance with ASTM D5116-90.

Doors shall carry a life of installation warranty from the manufacturer. All doors that are warped after installation, shall be replaced prior to substantial completion. Substantial completion cannot be achieved if one hour rated corridors integrity is compromised by warped doors.

Where doors are to be used as part of an acoustical barrier assembly, they shall be rated a minimum of STC 33.

Door receiving a stained finish shall have premium quality face veneers, minimum thickness 1/16". Doors receiving a paint finish shall be smooth, faux wood grain, or pre-primed skin.

Doors used as a normal means of ingress and egress shall have either vision panels or adjacent sidelights (where allowable by code) in metal frames.

Doors shall have a minimum of 3 heavy duty type hinges per door.

Doors and frames shall have a spray applied finish where specified.

DIVISION 8 – OPENINGS

**Section
Number**

Title

All doors subject to heavy traffic shall have kickplates both sides.

Part 3 - Execution

Inspection

The Contractor is required to have Owner's Carpentry department inspect and approve door installation after doors and jams have been installed and prior to casing installation. Failure to have approval will require the Contractor to remove the casing for inspection at Contractor's expense.

Wood frame pre-hung doors installed in renovations to existing buildings

All pre-hung interior door assemblies shall be inspected after hanging, and before the casing is applied. Assemblies which do not meet specifications shall be re-hung and re-inspected before casing is applied.

All paint grade doors shall be pre-primed.

Doors must be standard sizes whenever possible (ie: 6'-8" tall, 2'-0", 2'-4", 2'-6", 2'-8" or 3'-0" wide)

Installation

All pre-hung door assemblies shall be fastened to the framing with a minimum of 5 groups of 2, 2 ½" nails on both hinge and jamb sides.

Both jamb and hinge sides will use a minimum of three shimmed contact points.

One screw per hinge will penetrate the rough opening framing by at least 1"

Hinge, jamb, and head legs of the pre-hung assembly will be straight to within 1/8" deviation along their total length.

Hinge and jamb legs will be installed to within 1/8" of plumb.

Closed doors shall show a reveal of 1/8" on all three sides of the jamb unit, and ½" to ¾" above the finished flooring.

Doors shall open, close, and latch without excessive force.

Closet door hardware

When closet door ball catches are used, they shall be Grainger model 1VZX5C or equivalent.

08 17 00

Integrated Door Opening Assemblies

DIVISION 8 – OPENINGS

**Section
Number**

Title

Part 1 - General

Smoke and draft assemblies shall comply with IBC and IFC (or the most current building and fire codes).

Part 2 – Products

N/A

Part 3 – Execution

N/A

DIVISION 8 – OPENINGS

Section Number	Title
08 40 00	ENTRANCES, STOREFRONTS, AND CURTAIN WALLS
08 41 00	Entrances and Storefronts
08 41 13	Aluminum-Framed Entrances and Storefronts

Part 1 - General

Aluminum entrance section hardware shall meet all requirements in this section.

Part 2 – Products

All window openings shall be thermal broke, sill flashed to exterior, and flashing end dammed. All exterior glass shall be insulating glass, except vestibule doors and windows.

Bottom of window rough opening shall be a minimum of 12” above grade, slabs on grade, or other horizontal surfaces.

Glass manufacturer shall provide a written warranty that shall guarantee insulating glass units for a period of ten years.

Part 3 - Execution

Aluminum entrances and storefronts shall pass water leak testing prior to substantial completion and prior to payment for materials and labor. Test area shall include perimeter caulk joint. All failed windows shall be retested until they pass. All retesting and associated costs shall be paid for by the Contractor.

Weatherstripping for exterior doors shall be continuous at head, jambs, and door bottoms.

All aluminum doors will be wide stile with a mid-rail.

08 41 23	Steel-Framed Entrances and Storefronts
----------	--

Part 1 - General

Steel entrance section hardware shall meet all requirements in this section.

Part 2 – Products

Glass manufacturer shall provide a written warranty that shall guarantee insulating glass units for a period of ten years.

Part 3 – Execution

Steel entrances and storefronts shall pass water leak testing prior to substantial completion and prior to payment for materials and labor. Test area shall include perimeter caulk joint. All failed windows shall be retested until they pass. All

DIVISION 8 – OPENINGS

Section Number	Title
	retesting and associated costs shall be paid for by the Contractor.
	All window openings shall be thermal broke, sill flashed to exterior, and flashing end dammed. All exterior glass shall be insulating glass, except vestibule doors and windows.
	Weatherstripping for exterior doors shall be continuous at head, jambs, and door bottoms.
08 42 00	Entrances
08 42 29	Automatic Entrances
	<u>Part 1 - General</u>
	All automatic entrance doors shall comply with all door and hardware specifications contained in Division 8. Hardware shall meet all requirements in section 08 70 00.
	<u>Part 2 – Products</u>
	Glass manufacturer shall provide a written warranty that shall guarantee insulating glass units for a period of ten years.
	<u>Part 3 – Execution</u>
	Entrance doors shall pass water leak testing prior to substantial completion and prior to payment for materials and labor. Test area shall include perimeter caulk joint. All retesting and associated costs shall be paid for by the Contractor, via deduct change order.
	Weatherstripping for exterior doors shall be continuous at head, jambs, and door bottoms.
08 44 00	Curtain Wall and Glazed Assemblies
	<u>Part 1 - General</u>
	This section applies to exterior glazed curtain wall systems and storefronts (also used as fixed window systems). Curtain wall systems should be avoided on east and west exposures.
	A fabricator/erector shall have a minimum of 5 years of experience of similar size and scope in the fabrication and erection of systems specified in the project.
	<u>Part 2 - Products</u>
	Curtain wall systems shall utilize 1", dual pane insulated glass, fully tempered.

DIVISION 8 – OPENINGS

**Section
Number**

Title

Steel or hollow metal type system shall be used. Aluminum alloy extrusions are not acceptable in areas that support or are directly adjacent to door openings.

"Kynar 500" or equal shall be specified for painted finishes, spray applied.

Part 3 - Execution

Water penetration shall not occur at a test pressure of 7.00 psf when tested in accordance to ASTM E 331.

Entrances and storefronts shall pass water leak testing prior to substantial completion and prior to payment for materials and labor. Test area shall include perimeter caulk joint. All failed windows shall be retested until they pass. All retesting and associated costs shall be paid for by the Contractor.

Bottom of window rough opening shall be a minimum of 12" above grade, slabs on grade, or other horizontal surfaces.

Glass manufacturer shall provide a written warranty that shall guarantee insulating glass units for a period of ten years.

Maximum air infiltration shall not exceed 0.05 cfm per gross square foot of exterior area, when tested in accordance with ASTM E 283, section 4.3.

Where doors are utilized in curtain wall assemblies, at least one section of an exterior door assembly (main ingress and egress) shall have an electric automatic door opener, button activated at the swing side, interior and exterior.

In areas where the interior clear height of curtain walls exceed 30' (possibly an atrium) an interior system(s) must be designed to facilitate window washing without the use of erected scaffolding or movable lifts. On buildings that exceed 3 stories or 40' from finish grade, an exterior window washing system shall be designed.

DIVISION 8 – OPENINGS

Section Number	Title
08 50 00	WINDOWS
08 51 00	Metal Windows
	<u>Part 1 – General</u>
	Aluminum or any other type of metal sash windows shall have thermal breaks, sill flashed to the exterior, and flashing end dammed. All exterior glass shall be insulating glass.
	<u>Part 2 – Products</u>
	Glass manufacturer shall provide a written warranty that shall guarantee insulating glass units for a period of ten years.
	<u>Part 3 - Execution</u>
	All windows shall pass water leak testing prior to substantial completion and prior to payment for materials and labor.
	Test area shall include perimeter caulk joint. All failed windows shall be retested until they pass. All retesting and associated costs shall be paid for by the Contractor.
08 52 00	Wood Windows
08 52 16	Plastic-Clad Wood Windows
	<u>Part 1 – General</u>
	Vinyl clad wooden windows are the preferred specified product. All exterior glass shall be insulating glass.
	<u>Part 2 – Products</u>
	Glass manufacturer shall provide a written warranty that shall guarantee insulating glass units for a period of ten years.
	<u>Part 3 - Execution</u>
	All windows shall pass water leak testing prior to substantial completion and prior to payment for materials and labor.
	Test area shall include perimeter caulk joint. All failed windows shall be retested until they pass. All retesting and associated costs shall be paid for by the Contractor.

DIVISION 8 – OPENINGS

Section Number	Title
08 70 00	HARDWARE

PART 1 - GENERAL

1.1 SUMMARY

A. Section includes:

1. Mechanical door hardware for the following:
 - a. Swinging doors.
 - b. Sliding doors.
2. Cylinders for door hardware specified in other Sections.
3. Electrified door hardware.

B. Related Sections:

1. Section 08 11 13 "Hollow Metal Doors and Frames" for astragals provided as part of labeled fire-rated assemblies and for door silencers provided as part of hollow-metal frames.
2. Section 08 41 13 "Aluminum-Framed Entrances and Storefronts" for door silencers provided as part of aluminum frames.
3. Section 08 10 00 "Doors and Frames" for access door hardware, except cylinders.
4. Section 08 70 00, 2.16 "Overhead Stops and Holders" for door hardware provided as part of overhead door assemblies.
5. Section 10 22 13 "Wire Mesh Partitions" for door hardware for doors in wire mesh partitions, except cylinders.

1.2 ACTION SUBMITTALS

A. Product Data: For each type of product indicated. Include construction and installation details, material descriptions, dimensions of individual components and profiles, and finishes.

B. Shop Drawings: Details of electrified door hardware, indicating the following:

1. Wiring Diagrams: For power, signal, and control wiring and including the following:
 - a. Details of interface of electrified door hardware and building safety and security systems.
 - b. Schematic diagram of systems that interface with electrified door hardware.
 - c. Point-to-point wiring.
 - d. Risers.
 - e. Elevations doors controlled by electrified door hardware.
2. Operation Narrative: Describe the operation of doors controlled by

DIVISION 8 – OPENINGS

Section
Number

Title

electrified door hardware.

C. Other Action Submittals:

1. Door Hardware Schedule: Prepared by or under the supervision of Installer, detailing fabrication and assembly of door hardware, as well as installation procedures and diagrams. Coordinate final door hardware schedule with doors, frames, and related work to ensure proper size, thickness, hand, function, and finish of door hardware.
 - a. Submittal Sequence: Submit door hardware schedule concurrent with submissions of Product Data, Samples, and Shop Drawings. Coordinate submission of door hardware schedule with scheduling requirements of other work to facilitate the fabrication of other work that is critical in Project construction schedule.
 - b. Format: Comply with scheduling sequence and vertical format in the Door Hardware Institute's (DHI) "Sequence and Format for the Hardware Schedule." Double space entries, and number and date each page.
 - c. Format: Use same scheduling sequence and format and use same door numbers as in the Contract Documents.
 - d. Content: Include the following information:
 - 1) Identification number, location, hand, fire rating, size, and material of each door and frame.
 - 2) Locations of each door hardware set, cross-referenced to Drawings on floor plans and to door and frame schedule.
 - 3) Complete designations, including name and manufacturer, type, style, function, size, quantity, function, and finish of each door hardware product.
 - 4) Description of electrified door hardware sequences of operation and interfaces with other building control systems.
 - 5) Fastenings and other pertinent information.
 - 6) Explanation of abbreviations, symbols, and codes contained in schedule.
 - 7) Mounting locations for door hardware.
 - 8) List of related door devices specified in other Sections for each door and frame.
2. Keying Schedule: Prepared by or under the supervision of Installer, detailing Owner's final keying instructions for locks. Include schematic keying diagram and index each key set to unique door

DIVISION 8 – OPENINGS

**Section
Number**

Title

designations that are coordinated with the Contract Documents.

1.3 INFORMATIONAL SUBMITTALS

A. Qualification Data: For Installer.

B. Product Certificates: For electrified door hardware, from the manufacturer.

1. Certify that door hardware approved for use on types and sizes of labeled fire-rated doors complies with listed fire-rated door assemblies.

C. Product Test Reports: For compliance with accessibility requirements, based on evaluation of comprehensive tests performed by manufacturer and witnessed by a qualified testing agency, for door hardware on doors located in accessible routes.

1.4 CLOSEOUT SUBMITTALS

A. Maintenance Data: For each type of door hardware to include in maintenance manuals. Include final hardware and keying schedule.

1.5 QUALITY ASSURANCE

A. Installer Qualifications: Supplier of products and an employer of workers trained and approved by product manufacturers and an architectural hardware consultant who is available during the course of the Work to consult with Contractor, Design Professional, and Owner about door hardware and keying.

1. Warehousing Facilities: In Project's vicinity.
2. Scheduling Responsibility: Preparation of door hardware and keying schedules.
3. Engineering Responsibility: Preparation of data for electrified door hardware, including Shop Drawings, based on testing and engineering analysis of manufacturer's standard units in assemblies similar to those indicated for this Project.

B. Architectural hardware consultant qualifications: A person who is experienced in providing consulting services for door hardware installations that are comparable in material, design, and extent to that indicated for this project and who is currently certified by DHI as follows:

1. For door hardware, an Architectural Hardware Consultant (AHC).

C. Source Limitations: Obtain each type of door hardware from a single

DIVISION 8 – OPENINGS

Section
Number

Title

manufacturer.

1. Provide electrified door hardware from same manufacturer as mechanical door hardware, unless otherwise indicated. Manufacturers that perform electrical modifications and that are listed by a testing and inspecting agency acceptable to authorities having jurisdiction are acceptable.
- D. Fire-Rated Door Assemblies: Where fire-rated door assemblies are indicated, provide door hardware rated for use in assemblies complying with NFPA 80 that are listed and labeled by a qualified testing agency, for fire-protection ratings indicated, based on testing at positive pressure according to NFPA 252 or UL 10C, unless otherwise indicated.
- E. Smoke- and Draft-Control Door Assemblies: Where smoke- and draft-control door assemblies are required, provide door hardware that meet requirements of assemblies tested according to UL 1784 and installed in compliance with NFPA 105.
1. Air Leakage Rate: Maximum air leakage of 0.3 cfm/sq. ft. at the tested pressure differential of 0.3-inch wg of water.
- F. Electrified Door Hardware: Listed and labeled as defined in NFPA 70, Article 100, by a testing agency acceptable to authorities having jurisdiction.
- G. Means of Egress Doors: Latches do not require more than 15 lbf to release the latch. Locks do not require use of a key, tool, or special knowledge for operation.
- H. Accessibility Requirements: For door hardware on doors in an accessible route, comply with the U.S. Architectural & Transportation Barriers Compliance Board's ADA-ABA Accessibility Guidelines.
1. Provide operating devices that do not require tight grasping, pinching, or twisting of the wrist and that operate with a force of not more than 5 lbf.
 2. Comply with the following maximum opening-force requirements:
 - a. Interior, Non-Fire-Rated Hinged Doors: 5 lbf applied perpendicular to door.
 - b. Fire Doors: Minimum opening force allowable by authorities having jurisdiction.
 3. Bevel raised thresholds with a slope of not more than 1:2. Provide thresholds not more than 1/2 inch high.

DIVISION 8 – OPENINGS

**Section
Number**

Title

4. Adjust door closer sweep periods so that, from an open position of 70 degrees, the door will take at least 3 seconds to move to a point 3 inches from the latch, measured to the leading edge of the door.
 - I. Keying Conference: Conduct conference at Project site to comply with requirements in Division 1. In addition to Owner, Contractor, and Design Professional, conference participants shall also include installer's Architectural Hardware Consultant and Owner's security consultant. Incorporate keying conference decisions into final keying schedule after reviewing door hardware keying system including, but not limited to, the following:
 1. Function of building, flow of traffic, purpose of each area, degree of security required, and plans for future expansion.
 2. Preliminary key system schematic diagram.
 3. Requirements for key control system.
 4. Requirements for access control.
 5. Address for delivery of keys.
 - J. Preinstallation Conference: Conduct conference at Project site.
 1. Review and finalize construction schedule and verify availability of materials, Installer's personnel, equipment, and facilities needed to make progress and avoid delays.
 2. Inspect and discuss preparatory work performed by other trades.
 3. Inspect and discuss electrical roughing-in for electrified door hardware.
 4. Review sequence of operation for each type of electrified door hardware.
 5. Review required testing, inspecting, and certifying procedures.
- 1.6 DELIVERY, STORAGE, AND HANDLING
- A. Inventory door hardware on receipt and provide secure lock-up for door hardware delivered to Project site.
 - B. Tag each item or package separately with identification coordinated with the final door hardware schedule, and include installation instructions, templates, and necessary fasteners with each item or package.
 - C. Deliver keys and permanent cores to Owner in-person or by registered mail or overnight package service to certify delivery. Owner is not responsible for packages lost in the mail, and Contractor shall resend at Contractor's expense.

DIVISION 8 – OPENINGS

Section Number	Title
1.7	<p>COORDINATION</p> <p>A. Coordinate layout and installation of floor-recessed door hardware with floor construction. Cast anchoring inserts into concrete.</p> <p>B. Installation Templates: Distribute for doors, frames, and other work specified to be factory prepared. Check Shop Drawings of other work to confirm that adequate provisions are made for locating and installing door hardware to comply with indicated requirements.</p> <p>C. Security: Coordinate installation of door hardware, keying, and access control with Owner's security consultant.</p> <p>D. Electrical System Roughing-In: Coordinate layout and installation of electrified door hardware with connections to power supplies and building safety and security systems.</p> <p>E. Existing Openings: Where hardware components are scheduled for application to existing construction or where modifications to existing door hardware are required, field verify existing conditions and coordinate installation of door hardware to suit opening conditions and to provide proper door operation.</p>
1.8	<p>WARRANTY</p> <p>A. Special Warranty: Manufacturer's standard form in which manufacturer agrees to repair or replace components of door hardware that fail in materials or workmanship within specified warranty period.</p> <p>1. Failures include, but are not limited to, the following:</p> <ul style="list-style-type: none">a. Structural failures including excessive deflection, cracking, or breakage.b. Faulty operation of doors and door hardware.c. Deterioration of metals, metal finishes, and other materials beyond normal weathering and use. <p>2. Warranty Period: Three years from date of Substantial Completion, unless otherwise indicated.</p> <ul style="list-style-type: none">a. Locks: Ten (10) years from date of Substantial Completion.b. Electrified Locks: Two (2) years from date of Substantial Completion.c. Exit Devices: Five (5) years from date of Substantial Completion.

DIVISION 8 – OPENINGS

**Section
Number**

Title

- d. Manual Closers: Thirty (30) years from date of Substantial Completion.

PART 2 - PRODUCTS

2.1 SCHEDULED DOOR HARDWARE

- A. Provide door hardware for each door as scheduled in door hardware schedule to comply with requirements in this Section.
 - 1. Door Hardware Sets: Provide quantity, item, size, finish or color indicated, and products equivalent in function and comparable in quality to named products.
 - 2. Sequence of Operation: Provide electrified door hardware function, sequence of operation, and interface with other building control systems indicated.
- B. Designations: Requirements for design, grade, function, finish, size, and other distinctive qualities of each type of door hardware are indicated in door hardware schedule. Products are identified by using door hardware designations, as follows:
 - 1. Named Manufacturers' Products: Manufacturer and product designation are listed for each door hardware type required for the purpose of establishing minimum requirements. Manufacturers' names are abbreviated in door hardware schedule.
 - 2. References to Building Hardware Manufacturers Association (BHMA) Designations: Provide products complying with these designations and requirements for description, quality, and function.

2.2 HINGES

- A. Hinges: Follow BHMA A156.1. Provide template-produced hinges for hinges installed on hollow-metal doors and hollow-metal frames.
 - 1. IVES Hardware; an Allegion company
 - a. Heavy weight ball bearing hinges or standard weight hinges as required in 652 finish.
 - b. Provide 630 finish at out swinging exterior doors.

2.3 CONTINUOUS HINGES

- A. Continuous Hinges: BHMA A156.26; minimum 0.120-inch- thick, hinge leaves with minimum overall width of 4 inches; fabricated to full height of door and frame and to template screw locations; with components finished after milling and drilling are complete.
- B. Continuous, Gear-Type Hinges: Extruded-aluminum, pinless, geared

DIVISION 8 – OPENINGS

Section Number	Title
	hinge leaves joined by a continuous extruded-aluminum channel cap; with concealed, self-lubricating thrust bearings.
	1. IVES Hardware; an Allegion company
	a. 224HD Geared continuous hinges – UL type at rated doors
	b. Provide at all exterior entry and high abuse areas. All athlete area, performing arts, cafeteria doors, restrooms and all other doors over 48” wide.
2.4	MECHANICAL LOCKS AND LATCHES
	A. Cylindrical Locksets: BHMA A156.13; Operational Grade 1; stamped steel case with steel or brass parts;
	1. Schlage Commercial Lock Division; an Allegion company. Owner’s request.
	a. ND Series with Rhodes Levers in 626 finish, BD (less the small 7 pin removable core format)
	b. All locks to be supplied with Vandlgard feature.
	B. Mortise Locksets: BHMA A156.12; Operational Grade 1; constructed of solid stainless steel
	1. Schlage Commercial Lock Division; an Allegion company. Owner’s request.
	a. L Series with 06 Levers, N escutcheon in 626 finish
	b. LV9071 x XL12-751 on all classrooms
	c. LV9050 office function with L583-363 inside thumb turn on all office doors.
	d. All locks to be supplied with Vandlgard feature.
	e. NO MORTISE LOCKS ALLOWED ON NEW CONSTRUCTION UNLESS APPROVED BY OWNER.
	C. Deadlocks: BHMA A156.12; Operational Grade 1; constructed of solid stainless steel
	1. Schlage Commercial Lock Division; an Allegion company. Owner’s request.
	a. L400 series, 626 finish
	D. Cylinders:
	1. Schlage Commercial Lock Division; an Allegion company. Owner’s request.
	a. Rim and Morise cylinders, 626 finish, for small 7 pin removable core format.
2.5	ELECTROMECHANICALLOCKS

DIVISION 8 – OPENINGS

Section Number	Title
	<ul style="list-style-type: none">A. Electromechanical Locks: BHMA A156.25; Grade 1; motor or solenoid driven; mortise deadlocking latchbolt; with strike that suits frame.<ul style="list-style-type: none">1. Schlage Commercial Lock Division; an Allegion company. Owner's request.<ul style="list-style-type: none">a. Request-to-Exit built in to the inside lever
2.6	<p>SELF-CONTAINED ELECTRONIC LOCKS</p> <ul style="list-style-type: none">A. Self-Contained Electronic Locks: BHMA A156.25, mortise; with internal, battery-powered, self-contained electronic locks; consisting of complete lockset, motor-driven lock mechanism, and actuating device; enclosed in zinc-dichromate-plated, wrought-steel case, and strike that suits frame. Provide key override, low-battery detection and warning, LED status indicators, and ability to program at the lock.<ul style="list-style-type: none">1. Schlage Commercial Lock Division; an Allegion company.
2.7	<p>AUTOMATIC AND SELF-LATCHING FLUSH BOLTS</p> <ul style="list-style-type: none">A. Automatic and Self-Latching Flush Bolts: BHMA A156.16; minimum 3/4-inch throw; designed for mortising into door edge.<ul style="list-style-type: none">1. IVES Hardware; an Allegion company.
2.8	<p>EXIT DEVICES AND AUXILIARY ITEMS</p> <ul style="list-style-type: none">A. Exit Devices and Auxiliary Items: BHMA A156.3.<ul style="list-style-type: none">1. Von Duprin; an Allegion company<ul style="list-style-type: none">a. CD99 series rim panic exit devices in 626 finish on non-rated openings.b. 99L-F-2 series rim panic exit devices in 626 finish on rated openings with 996L break-away levers.c. Exterior doors requiring exit hardware must have cylinder dogging feature (CD).d. Where applicable use the 9949 cable exit devicee. Mullions – KR9954 key removable mullions on both rated and non-rated doors.
2.9	<p>PERMANENT CORES</p> <ul style="list-style-type: none">A. Permanent cores: Tumbler type, constructed from brass or bronze, stainless steel, or nickel silver.<ul style="list-style-type: none">1. Best Locks, a Stanley Security Company<ul style="list-style-type: none">a. Small Format 7 pin removable coreb. D, E, J, K, L, M, F, G, H, Q, WC, WG, TD, SC, WH and TB keyways.c. Provide construction cores that are replaceable by permanent cores.

DIVISION 8 – OPENINGS

Section Number	Title
2.10	KEYING
	A. Keying System:
	1. Best Locks, a Stanley Security Company
	a. All cores to be keyed to the Owner's existing Grand Master Key System. Please contact Owner's Building Access Services to determine the keyway to be used on each project.
	B. Keys:
	1. Stamping: Permanently inscribe each key with a visual key control number and include the following notation:
	a. Notation: "DO NOT DUPLICATE."
	2. Quantity: In addition to one extra key blank for each lock, provide the following:
	a. Cylinder Change Keys: Three
	b. Master Keys: Three
	c. Control Key: Two
	d. Construction Operating Keys: Ten
	e. Construction Control Key: Three
2.11	KEY CONTROL SYSTEM
	A. Key Control Cabinet: BHMA A156.5; metal cabinet with baked-enamel finish; containing key-holding hooks, labels, 2 sets of key tags with self-locking key holders, key-gathering envelopes, and temporary and permanent markers; with key capacity of 150 percent of the number of locks.
	1. Multiple-Drawer Cabinet: Cabinet with drawers equipped with key-holding panels and key envelope storage, and progressive-type ball-bearing suspension slides. Include single cylinder lock to lock all drawers.
	B. Key Lock Boxes: Designed for storage of two keys, with tamper switches to connect to intrusion detection system.
	1. Manufacturers: Subject to compliance with requirements, provide products by the following:
	a. Knox Company.
2.12	SURFACE CLOSERS
	A. Surface Closers: BHMA A156.4; rack-and-pinion hydraulic type with adjustable sweep and latch speeds controlled by key-operated valves and forged-steel main arm. Comply with manufacturer's written recommendations for size of door closers depending on size of door,

DIVISION 8 – OPENINGS

Section
Number

Title

exposure to weather, and anticipated frequency of use. Provide factory-sized closers, adjustable to meet field conditions and requirements for opening force.

1. LCN Closers; an Allegion company.
 - a. 4040XP Series EDA (Extra Heavy Duty Arm) surface mounted
 - b. Powder coated aluminum finish (689).
 - c. Spring Cush Arms (SCUSH) allowed on 90 degree openings.
 - d. Hold Open arms (H) can be used but must be approved by Owner.
 - e. Gate Closers; 4000T Series – ST-3592 with SRI plating, with 4041-18 drop plate for mounting.
2. Allegion LCN 4040XP-EDA-TBWMS-ALUM closers must be installed by through-bolting the closer (with sexnuts) to the door with 1/4-20 hardware. The closer shoe must be attached to the frame by all five mounting points. In the case of aluminum frames, the shoe must be attached with 1/4-20 nutserts (aka rivetnuts) installed in the frame and using LCN 4040-61 Blade Stop Spacers. If necessary due to inadequate jamb reveal, the fifth attachment point will be accomplished by using LCN 4040-30 Cush Shoe Supports.

Frames shall be the following or approved equal:

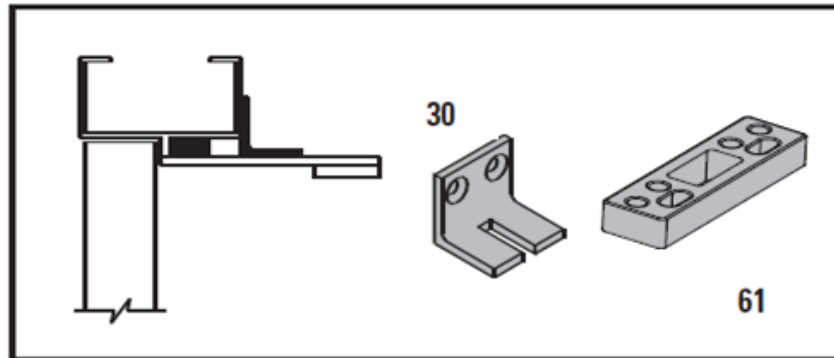

CUSH SHOE SUPPORT, 4040-30 provides anchorage for fifth screw used with CUSH arms, where reveal is less than 3 1/16" (78 mm).

BLADE STOP SPACER, 4040-61 required to lower parallel arm shoe to clear 1/2" (13 mm) blade stop.

2.13 CLOSER HOLDER RELEASE DEVICES

- A. Closer Holder Release Devices: BHMA A156.15; Grade 1; closer connected with separate or integral releasing and fire- or smoke-detecting devices. Door shall become self-closing on interruption of

DIVISION 8 – OPENINGS

Section Number	Title
	signal to release device. Automatic release is activated by smoke detection system.
	1. LCN Closers; an Allegion company. <ul style="list-style-type: none">a. 4040SE Seriesb. Powder coated aluminum finish (689).
2.14	MECHANICAL STOPS AND HOLDERS <ul style="list-style-type: none">A. Wall- and Floor-Mounted Stops: BHMA A156.16; aluminum base metal.<ul style="list-style-type: none">1. IVES Hardware; an Allegion company<ul style="list-style-type: none">a. FS18S Heavy Duty floor type, black finish.b. WS401 Series Convex or Concave wall stops in 626 finish
2.15	ELECTRONIC STOPS AND HOLDERS <ul style="list-style-type: none">A. Wall Mount: BHMA A156<ul style="list-style-type: none">1. LCN Closers; an Allegion company.<ul style="list-style-type: none">a. SEM7850 Die cast housing, standard profile recessed wall mount. Tri-Voltage design.
2.16	OVERHEAD STOPS AND HOLDERS <ul style="list-style-type: none">A. Overhead Stops and Holders: BHMA A156.8.<ul style="list-style-type: none">1. IVES Hardware; an Allegion company<ul style="list-style-type: none">a. 900 Series surface mounted, 626 finish.
2.17	METAL PROTECTIVE TRIM UNITS <ul style="list-style-type: none">A. Metal Protective Trim Units: BHMA A156.6; fabricated from 0.050-inch-thick stainless steel; with manufacturer's standard machine or self-tapping screw fasteners.<ul style="list-style-type: none">1. IVES Hardware; an Allegion company<ul style="list-style-type: none">a. 8400 Series, 12" high, beveled 4 sides, counter sunk screws, 630 finishb. Latch Guards on all exterior doors where required
2.18	DOOR GASKETING <ul style="list-style-type: none">A. Door Gasketing: BHMA A156.22; air leakage not to exceed 0.50 cfm per foot of crack length for gasketing other than for smoke control, as tested according to ASTM E 283; with resilient or flexible seal strips that are easily replaceable and readily available from stocks maintained by manufacturer.<ul style="list-style-type: none">1. Zero International<ul style="list-style-type: none">a. Brush Type seals are the preference

DIVISION 8 – OPENINGS

Section Number	Title
2.19	THRESHOLDS
	A. Thresholds: BHMA A156.21; fabricated to full width of opening indicated. <ol style="list-style-type: none">1. Zero International
2.20	FINISHES
	A. Provide finishes complying with BHMA A156.18 as indicated in door hardware schedule.
	B. Protect mechanical finishes on exposed surfaces from damage by applying a strippable, temporary protective covering before shipping.
	C. Appearance of Finished Work: Variations in appearance of abutting or adjacent pieces are acceptable if they are within one-half of the range of approved Samples. Noticeable variations in the same piece are not acceptable. Variations in appearance of other components are acceptable if they are within the range of approved Samples and are assembled or installed to minimize contrast.

PART 3 - EXECUTION

3.1	EXAMINATION
	A. Examine doors and frames, with Installer present, for compliance with requirements for installation tolerances, labeled fire-rated door assembly construction, wall and floor construction, and other conditions affecting performance.
	B. Examine roughing-in for electrical power systems to verify actual locations of wiring connections before electrified door hardware installation.
	C. Proceed with installation only after unsatisfactory conditions have been corrected.
3.2	PREPARATION
	A. Steel Doors and Frames: For surface applied door hardware, drill and tap doors and frames according to ANSI/SDI A250.6.
	B. Wood Doors: Comply with DHI WDHS.5 "Recommended Hardware

DIVISION 8 – OPENINGS

Section
Number

Title

Reinforcement Locations for Mineral Core Wood Flush Doors."

3.3 INSTALLATION

- A. Mounting Heights: Mount door hardware units at heights indicated on Drawings unless otherwise indicated or required to comply with governing regulations.
 - 1. Standard Steel Doors and Frames: ANSI/SDI A250.8.
 - 2. Custom Steel Doors and Frames: HMMA 831.
 - 3. Wood Doors: DHI WDHS.3, "Recommended Locations for Architectural Hardware for Wood Flush Doors."
- B. Install each door hardware item to comply with manufacturer's written instructions. Where cutting and fitting are required to install door hardware onto or into surfaces that are later to be painted or finished in another way, coordinate removal, storage, and reinstallation of surface protective trim units with finishing. Do not install surface-mounted items until finishes have been completed on substrates involved.
 - 1. Set units level, plumb, and true to line and location. Adjust and reinforce attachment substrates as necessary for proper installation and operation.
 - 2. Drill and countersink units that are not factory prepared for anchorage fasteners. Space fasteners and anchors according to industry standards.
- C. Hinges: Install types and in quantities indicated in door hardware schedule but not fewer than the number recommended by manufacturer for application indicated or one hinge for every 30 inches of door height, whichever is more stringent, unless other equivalent means of support for door, such as spring hinges or pivots, are provided.
- D. Intermediate Offset Pivots: Where offset pivots are indicated, provide intermediate offset pivots in quantities indicated in door hardware schedule but not fewer than one intermediate offset pivot per door and one additional intermediate offset pivot for every 30 inches of door height greater than 90 inches.
- E. Lock Cylinders: Install construction cores to secure building and areas during construction period.
 - 1. Replace construction cores with permanent cores as directed by Owner.

DIVISION 8 – OPENINGS

Section
Number

Title

2. Furnish permanent cores to Owner for installation.
- F. Boxed Power Supplies: Locate power supplies as indicated or, if not indicated, above accessible ceilings. Verify location with Design Professional.
 1. Configuration: Provide least number of power supplies required to adequately serve doors with electrified door hardware.
- G. Thresholds: Set thresholds for exterior doors and other doors indicated in full bed of sealant complying with requirements specified in Section 07 92 00 "Joint Sealants and Caulking".
- H. Stops: Provide floor stops for doors unless wall or other type stops are indicated in door hardware schedule. Do not mount floor stops where they will impede traffic.
- I. Perimeter Gasketing: Apply to head and jamb, forming seal between door and frame.
- J. Meeting Stile Gasketing: Fasten to meeting stiles, forming seal when doors are closed.
- K. Door Bottoms: Apply to bottom of door, forming seal with threshold when door is closed.

3.4 ADJUSTING

- A. Initial Adjustment: Adjust and check each operating item of door hardware and each door to ensure proper operation or function of every unit. Replace units that cannot be adjusted to operate as intended. Adjust door control devices to compensate for final operation of heating and ventilating equipment and to comply with referenced accessibility requirements.
 1. Spring Hinges: Adjust to achieve positive latching when door is allowed to close freely from an open position of 30 degrees.
 2. Electric Strikes: Adjust horizontal and vertical alignment of keeper to properly engage lock bolt.
 3. Door Closers: Adjust sweep period to comply with accessibility requirements and requirements of authorities having jurisdiction.
- B. Occupancy Adjustment: Approximately three months after date of Substantial Completion, installer's Architectural Hardware Consultant shall examine and readjust each item of door hardware, including

DIVISION 8 – OPENINGS

**Section
Number**

Title

adjusting operating forces, as necessary to ensure function of doors, door hardware, and electrified door hardware.

3.5 CLEANING AND PROTECTION

- A. Clean adjacent surfaces soiled by door hardware installation.

- B. Clean operating items as necessary to restore proper function and finish.

- C. Provide final protection and maintain conditions that ensure that door hardware is without damage or deterioration at time of Substantial Completion.

DIVISION 8 – OPENINGS

**Section
Number
08 80 00
08 81 00**

**Title
GLAZING
Glass Glazing
Part 1 – General**

Dual pane 1" insulated glass at a minimum shall be on all exterior windows.

Side lights and/or door lights to be tempered float glass.

All glass within contact by pedestrian traffic to be tempered.

Individual windows or window assemblies shall easily accommodate washing of the exterior surface.

Exterior ledges of window openings shall allow proper drainage away from the window assembly, 1/2" per foot minimum.

All window assemblies shall be fully weatherstripped and gasketed.

All glass types shall be a local stock item to eliminated replacement delays.

Part 2 – Products
N/A

Part 3 – Execution
N/A

*** * * END OF SECTION * * ***

Section Number	Title
09 00 00	FINISHES
09 01 00	Maintenance of Finishes
09 20 00	PLASTER AND GYPSUM BOARD
09 21 00	Gypsum Board Assemblies
09 24 00	Cement Plastering
09 24 23	Cement Stucco
09 30 00	TILING
09 30 13	Ceramic Tiling
09 50 00	CEILINGS
09 51 00	Acoustical Ceilings
09 60 00	FLOORING
09 62 00	Specialty Flooring
09 62 23	Bamboo Flooring
09 65 00	Resilient Flooring
09 65 13	Resilient Base and Accessories
09 65 19	Resilient Tile Flooring
09 66 00	Terrazzo Flooring
09 68 00	Carpeting
09 68 13	Carpet Tile
09 68 16	Sheet Carpet
09 70 00	WALL FINISHES
09 72 00	Wall Coverings
09 90 00	PAINTING AND COATING
09 91 00	Painting
09 91 13	Exterior Painting
09 91 23	Interior Painting
09 96 00	High Performance Coatings
09 96 13	Abrasion-Resistant Coatings
09 96 23	Graffiti-Resistant Coatings
09 96 53	Elastomeric Coatings
09 97 00	Special Coatings
09 97 35	Dry Erase Coatings

Section Number	Title
09 00 00	FINISHES
09 01 00	Maintenance of Finishes
	<u>Part 1 – General</u>
	Finishes shall be designed so they are easy to maintain. For example, rocks shall not be specified for under stairwells as they are hard to keep clean.
	<u>Part 2 – Products</u>
	N/A
	<u>Part 3 – Execution</u>
	N/A
09 20 00	PLASTER AND GYPSUM BOARD
09 21 00	Gypsum Board Assemblies
	<u>Part 1 – General</u>
	This required specification describes various levels of finish gypsum board surfaces prior to the application of specific types of final decoration. The recommended level of finish of gypsum wallboard and the ceiling surfaces varies with the final decoration to be applied and can also be dependent on their location in a structure and the type of illumination striking the surface. Each recommended level of finish is described within typical applications.
	<u>Definitions</u>
	Accessories: Metal or plastic beads, trim, or molding used to protect or conceal corners, edges, or abutments of the gypsum board construction.
	Critical Lighting: Strong side lighting from windows or surface-mounted light fixtures. (See “comments” section of this document).
	Joint Photographing: The shadowing of the finished joint areas through the surface decoration.
	Primer Sealer: A paint material formulated to fill the pores and equalize the suction between gypsum board surface paper and the compound used on finish joints, angles, fastener heads, and accessories, and over skim coatings.
	Skim Coating: A thin coat of joint compound over the entire surface to fill imperfections in the joint work, smooth the paper texture, and provide uniform surface for decorating.
	Texture: Regular or irregular pattern typically produced by applying a mixture of joint compound and water, or proprietary texture materials including latex-based texture paint, to a gypsum board surface previously coated with primer/sealer.
	Texturing: A decorative treatment of gypsum board surfaces.
	<u>Design</u>

Section
Number

Title

Owner requires a minimum level 4 finish with texture unless areas are not accessible to the public or inhabitants of the structure (attics, mechanical rooms, etc.). However, these areas must still be finished to adequately meet fire code standards such as level 1 or 2.

Level 0: No taping, finishing or accessories required. **This level of finish may be useful in temporary construction or whenever the final decoration has not been determined.**

Level 1: All joints and interior angles shall have tape embedded in joint compound. Surfaces shall be free of excess joint compound. Tool marks and ridges are acceptable. Frequently specified in plenum areas above ceilings, in attics, in areas where the assembly would generally be concealed, or in building service corridors and other areas not normally open to public areas with pedestrian traffic. Some degree of sound and smoke control is provided; in some geographic areas this level is referred to as “fire taping”. Where a fire resistance rating is required for the gypsum board assembly, details of construction shall be in accordance with reports of fire tests of assemblies that have met the fire rating equipment.

Level 2: All joints and interior angles shall have tape embedded in joint compound and one separate coat of joint compound applied over all joints, angles, fastener heads, and accessories. Surface shall be free of excess joint compound. Tool marks and ridges are acceptable. Specified where water resistance gypsum backing board (ASTM c630) is used as a substrate for tile; may be specified in garages, warehouse storage or other similar areas where surface appearance is not of primary concern.

Level 3: All joints and interior angles shall have tape embedded in joint compound and two separate coats of joint compound applied over all joints, angles, fastener heads, and accessories. All joint compounds shall be smooth and free of tool marks and ridges. Note: It is recommended that the prepared surface be coated with a primer/sealer prior to the application of final finishes. See painting/wallcovering specification in this regard. Typically specified in appearance areas which are to receive heavy or medium texture (spray or hand applied) finishes before final painting, or where heavy grade wallcoverings are to be applied as the final decoration. **This level of finish is *not to be used* where smooth painted surfaces or light to medium weight wallcoverings are specified.**

Level 4: All joints and interior angles shall have tape embedded in joint compound and three separate coats of joint compound applied over all joints, angles, fastener heads, and accessories. All joint compounds shall be smooth and free of tool marks and ridges. Note: The prepared surface shall be coated

Section
Number

Title

with a primer/sealer prior to the application of final finishes. See painting/wallcovering specification in this regard. ***This level should not be specified without texture. It is acceptable where wallcoverings are to be applied.*** The weight, texture, and sheen level of wallcoverings applied over this level of finish should be carefully evaluated. Joints and fasteners must be adequately concealed if they wallcovering material is lightweight, contains limited pattern, has a gloss finish, or any combination of these features is present. Unbacked vinyl wallcoverings are not to be used over this level of finish.

Level 5: All joints and interior angles shall have tape embedded in joint compound and three separate coats of joint compound applied over all joints, angles, fastener heads, and accessories. A thin skim coat of joint compound, or a material manufactured especially for this purpose, shall be applied to the entire surface. The surface shall be smooth and free of tool marks and ridges. Note: The prepared surface shall be coated with a primer/sealer prior to the application of finish paint. **This level of finish is to be used where gloss, semi-gloss, enamel, or non-textured flat paints are specified or where severe lighting conditions occur.**

Part 2 –Products

5/8" fire rated gypsum panels

5/8" fiber rock panels where specified

5/8" fire rated aqua block gypsum panels (green board) where specified

Aqua Block Gypsum panels (green board) shall be used at all wet walls at a minimum.

Cement board panels shall be used at all showers, tubs, etc.

Part 3 – Execution

Sheetrock will be installed by fastening with coated drywall screws. The screws must penetrate no less than 5/8" into the studs. All end joints will be broken at a stud. All joints will be staggered by a minimum of 24". Joints will not be broken at the edge of a door jam or window; they must continue past the edge by a minimum of 10". Screw heads must be countersunk enough to allow joint compound over them without causing a ridge, but not enough to break the paper on the gypsum rendering the fastener non-functional. All blisters, loose paper, broken corners, and feathered paper must be removed before any taping or finishing can occur. Corner bead installed with metal stud construction must be pated on type or metal. The metal type must be fastened with screws a minimum of 8" on the center apart. In the event of wood construction, metal corner bead may be fastened with 1 ¼" staples at a minimum of 6" on center. All corner beads (except tape on type) must then be taped at the edges with joint tape.

Section
Number Title

If contractor is using backer board for wet environments the screws must meet manufacturers' requirements by being corrosion resistant.

Screw Schedule

Screw Type	Minimum spacing	Sheer wall spacing	Green board spacing
Drywall #8	8" o.c.	6" o.c.	6" o.c. ceiling 8" o.c. walls

This screw schedule is applicable to walls and ceilings unless specified otherwise (as in green board schedule).

Texturing

NO TAPING WILL OCCUR UNTIL ALL BLISTERS AND OR FEATHERED EDGES, AND LOOSE PAPER ARE REPAIRED.

Texture must be applied evenly, specific to the type of texture, free of any tool marks or ridges.

09 24 00 CEMENT PLASTERING
09 24 23 Cement Stucco

Part 1 – General

N/A

Part 2 – Products

N/A

Part 3 – Execution

Installation of Exterior Sheathing Materials

- A. Acceptable Materials. There are several code recognized wall sheathing products intended for use under stucco applications. In local residential construction, the most common include plywood and oriented strand board (OSB). Owner requires greater stiffness for wall sheathing when stucco is to be applied.
- B. Panel Selection and Application. To increase stiffness, panels should be applied with the strength axis across the studs. For stud spacing of 16 inches on center, APA makes the following recommendations:
 - 1. With the strength axis perpendicular to the studs – 3/8" and 7/16" minimum panel thickness and minimum span ratings of 24/0 and 24/16
 - 2. With the strength axis parallel to the studs – 15/32" and 1/2 " minimum panel thickness and a minimum span rating of 32/16 for OSB or 5-ply/5-

Section
Number

Title

layer plywood. Structural 1 Rated Sheathing (OSB) 7/16" thickness and span rated 24/16 may also be used.

3. The above will require sheathing to be installed with the long side horizontal (where the strength axis runs in the long panel dimension). With blocking between studs along horizontal panel joints.
- C. Spacing Requirements. Spacing of 1/8" is required at panel ends and edges. This allows for some minor panel swelling if wetting occurs during the construction process. Greater spacing may be required at locations of expected movement, such as the band joist, particularly when using surfaced green dimensional lumber.
- D. Nailing Pattern / Schedule. Owner requires nailing 6" o.c. along supported panel edges and 12" o.c. at intermediate supports with 6d common nails, or 16 ga. 7/16" crown 1-3/4" leg staples, or 1-5/8" length nails with a shank diameter of .097" - .099". All fasteners are to be located 3/8" from panel edges. For shear wall applications closer spacing, or different sizes will be necessary.

Installation of Weather Resistive Barrier (WRB) Or Secondary Drainage Plane

This is a layer, separate from, and in addition to, the paper found immediately behind the stucco lath. While there are several materials that can be used to create a drainage plane, there is similarity in their installation. All are installed in a shingle type fashion, so as to shed water from the upper layer(s), out over the lower layers, and ultimately back to the outside of the wall. Installation starts at the bottom of the wall and works upward, overlapping successive courses. This installation must be continuous and prevent water from finding its way into the wall cavity. As such, special attention must be paid to details of interfaces between the secondary drainage plane and windows, doors, roofs, flashings, etc. With the drainage plane installed no sheathing (i.e. OSB) should be exposed and any tears in the drainage plane must be repaired. The drainage plane must run under windows, corner boards, window wraps and around corners.

- A. Acceptable Materials. There are several code-recognized materials for this purpose. Commonly used materials are grade D building paper, 15 pound asphalt building felt, and housewrap. The material must be vapor permeable to allow water vapor to pass thru the wall, however, it must be water resistant.
- B. Installation Methods for Building Paper and Felt. Paper can be installed prior to, or after, window installation. Special care must be taken at the interface with windows and doors (see Installation of Windows). The installation starts

Section
Number

Title

with the bottom course being applied. Subsequent courses are installed horizontally (not at an angle) working upwards, in shingle fashion. The horizontal lap must be at least 2". At end laps there must be at least a 6" lap. At corners (inside or outside), the paper must run at least 6" around the corner. At inside corners, care must be taken to keep the weather resistant barrier tight to the corner so lath can later be installed. Where intersecting a roof the paper should overlap the upturned leg of step or headwall flashings. Paper should be fastened with wide crown staples (at least 1"), cap nails, or large head nails every 12" to 18". Best practice is to fasten to studs, not sheathing, so the lath installer can locate studs.

- C. Installation Methods for Housewrap. Housewrap can be installed prior to, or after, window installation. Special care must be taken at the interface with windows and doors (see Installation of Windows). The installation starts with the bottom course being applied. Subsequent courses are installed horizontally (not at an angle) working upwards, in shingle fashion. Some housewraps can be applied in only one direction (StuccoWrap), some have an inside and outside face. The horizontal lap must be at least 6". At end laps there must be a 6" lap. At corners (inside or outside), the housewrap must run 6" around the corner. Care must be taken to keep the weather resistant barrier tight to the corner so that lath can later be installed. Where intersecting a roof, the housewrap should overlap the upturned leg of step or headwall flashings. Housewrap should be fastened with wide crown staples (at least 1"), cap nails, or large head nails every 12" to 18". Refer to the manufacturer's installation instructions for further information. Best practice is to fasten through sheathing to studs, so the lath installer can locate studs.

Installation of Windows, Doors, and Trim & Integration to Drainage Plane

- A. Window Installation. It is required that the installation of the first layer of protection (the one closest to the sheathing), the weather resistive barrier, be done prior to the windows and doors being installed.
1. Installing windows with brick mold creates additional considerations. Housewrap must be installed before the window is installed. First, housewrap is installed, and then a pan flashing should be installed at the rough sill and integrated with the housewrap. A bead of sealant must be applied to the backside of the brick mold, or on the wall to bed the brick mold on three sides, before installation of the window. Drip cap flashing must be installed at the head of the brick mold. The use of casing bead, backer rod and proper caulk will be used for the head, sides, and sill.
 2. Window Trims. When trimming windows with wood trim the contractor must be aware of the dissimilar movement between the various materials when changes in temperature and moisture occur. For

Section
Number

Title

example, vinyl windows will move more than wood trim, which will move more than stucco. Because of this, backer rod and proper caulk at these joints, along with a properly designed joint, will be used.

- B. Door Installation. When installing doors, which typically have brick mold, the steps outlined for windows will be followed. Extra care should be given to doors that are not protected by some form of overhang. Casing bead, backer rod and proper caulk at the joint between stucco and brick mold will be used.
- C. Drip Cap Flashing Integration. Drip cap flashing will be installed above all projecting wood trim and above windows that do not have a self-flashing nailing fin. This flashing is installed with the vertical back leg on the outside of the drainage plane. When the paper immediately under the lath is installed, it will overlap the back leg in a shingle type fashion.

Roofing Integration to the Drainage Plane

- A. Key Elements:
 - 1. Roof flashings must provide proper “kick out” from behind all siding, stucco and others.
 - 2. The vertical “back leg” of roof flashings must be installed behind the drainage plane.
 - 3. Stucco must not be installed until proper kick out of flashings is achieved.
- B. Providing proper “kick out”
 - 1. Roof installation is to be performed in a fashion whereby roof flashings are installed to provide proper “kick out” to divert precipitation (run-off) to the exterior of the siding product.
 - 2. Owner requires contractors to furnish and install “oversized” kick out flashings at all areas of the roof where flashings must be deliberately drawn out from behind the siding. Specifically, pre-manufactured, oversized kick out flashings are recommended at the 1st course or row of roofing, when the 1st course or row of roofing abuts stucco. The 1st flashing, where abutting a stucco wall, should be an oversized / pre-manufactured kick out flashing to divert water from behind the stucco into gutter.
 - 3. At all exterior corners where “kick out” is required, flashings must extend sufficiently past the corners. 2-inches minimum extension is recommended. The vertical leg of roof flashings should be a minimum of 3-inches tall, but should be fabricated to only rise 2inches vertically at the extended portion of the flashing (portion of flashing properly extending past corner). This allows the stucco contractor to then install their casing bead 2-inches above the roof deck, providing an approximately 1-inch

Section
Number

Title

overlap of the vertical leg of the roof flashing, without having to modify the roofing contractors' work, where flashing extends past the corner. If any modification of roof flashings or roofing materials is believed necessary, it is recommended the roofing contractor be called upon to perform it.

4. With the intent of being able to provide for the future replacement, maintenance, and repair of roof flashings at wall junctures, best practice will insure that flashings are not permanently imbedded behind stucco siding. Two possible means by which this can be achieved include:
 - a. Wall flashings may be covered by wood trim, which is installed with a drip cap.
 - b. The casing bead channel at the bottom of stucco siding can be installed in a fashion which allows for roof flashings to be easily maneuvered behind the "J" channel flashing or out from behind the "J" channel flashing.

C. Roof flashings properly installed behind drainage plane

1. Flashings, for the purpose of this discussion shall be defined as those building materials used in effort to provide a watertight "connection" between the roof and any protrusion through, or adjacent to, the roof plane (i.e. sidewalls, chimneys, vent pipes, skylights, etc.)
2. Drainage plane, for the purpose of this discussion shall be defined as the inner most water resistive barrier, installed on the exterior of the sheathing for the purpose of protecting the interior from the intrusion of water.
3. The back leg of all roof flashings must be installed with the upturned vertical leg behind the drainage plane.
4. All roof flashings must be installed in a fashion whereby proper "kick out" of flashings from behind the drainage plane is achieved, as necessary to divert precipitation (run-off) to the exterior of siding.

D. Stucco shall not be installed until proper kick out is provided

1. Those installing stucco siding must be sufficiently knowledgeable in recognizing the proper installation of necessary kick out flashings.
2. The stucco contractor bears responsibility for knowing that application of stucco siding over flashings that do not divert water to the exterior of siding will likely result in water intrusion of the interior and is therefore improper.
3. If there is any question that flashings will not provide proper kick out, the stucco contractor shall not install stucco at questionable areas until the flashing unquestionably provides proper kick out.

Section
Number

Title

4. Under no circumstance should stucco siding be installed over flashings which would fail to properly divert precipitation / moisture past the exterior surface of the stucco siding.

Integration of Penetrations to the Drainage Plane

- A. Generally, small penetrations through the stucco can be caulked to successfully keep water out of the wall. Several areas that warrant specific attention are listed below.
- B. Plumbing Penetrations. Sillcocks, installed in walls that are to have stucco applied, should be held out of the wall to accommodate the thickness of the stucco. After the stucco has been installed the sillcock should be caulked to the stucco wall.
- C. Electrical Penetrations. Electrical boxes, used in walls that are to have stucco applied, should be held out of the wall to accommodate the thickness of the stucco. After the device is installed, it should be caulked to the stucco wall. Examples include lighting fixtures, weatherproof receptacles, etc.
- D. Electric Meters. Electric meters, in walls that are to have stucco applied, should be installed over the drainage plane, or installed with a weather resistive barrier behind it, to later interface with the drainage plane. A drip cap flashing should be considered for placement above the meter can. The vertical back leg of the flashing should be on top of the drainage plane. The paper behind the lath should go over this back leg. After installation of the stucco, the meter can sides and bottom should be caulked to the stucco.
- E. Other Penetrations. Walls may have many other penetrations such as dryer vents, fireplace termination caps, and furnace exhaust. Each of these must be sealed to the stucco wall with an appropriate sealant.

Lath Installation Requirements

- A. Lap metal lath ½" minimum on sides (the long dimension) and 1" on ends (the short dimension). End laps should occur over studs.
- B. For paper backed lath, the vertical and horizontal joints should be backing-to-backing, and metal on metal. The paper should never extend over the lath and should be shingled.
- C. Metal plaster bases should be attached to framing members (studs) at not more than 7" along framing members. It is intended to have the lath

Section
Number

Title

attached to the studs. The attachment should be thru the self-furring mechanism only, i.e. fasten through dimples or v-groove, so as not to reduce embedment of the lath in the stucco. In lieu of wire tying the lath, a limited number of staples may be utilized to secure the lath to the exterior facade.

- D. Care should be taken so as to not over staple self-furring lath. Over stapling can depress the lath to a point where it is impossible to get the lath imbedded into the plaster cement.
- E. The fasteners used to attach the metal base must penetrate studs $\frac{3}{4}$ ". As staples are prevalent, they would need to be a minimum of $1\frac{1}{4}$ " in length (assuming $\frac{7}{16}$ inch sheathing), with a crown of not less than $\frac{3}{4}$ ".
- F. Metal lath should be applied with the long dimension at right angles to supports. For narrow wall panels (less than 24 inches), it is generally acceptable to apply the long dimension parallel to the framing members. It shall be permissible to follow the roof rake on gables.
- G. Ends of adjoining plaster bases should be staggered.
- H. Lath will not be continuous through control (expansion and contraction) joints. It will be cut, with the accessory attached over the lath and attached (wire tied or stapled) at each side, not more than 7" o.c. When cutting the lath care must be taken not to damage the weather resistant barrier (the drainage plane closest to the sheathing).
- I. Control/expansion joints should be installed to delineate areas of not more than 144 sq. ft.
- J. The distance between control/expansion joints shall not exceed 18 ft. in any direction or a $2\frac{1}{2}$ to 1 length to width ratio. Control/expansion joints should be located where movement is anticipated.
- K. Where expansion joints intersect in a perpendicular fashion the vertical member shall be installed first and be continuous.
- L. External corner reinforcement shall be used where corner bead is not used.
- M. At internal corners, there are various details that one may follow dependent upon the situation. When installing the lath or accessory, extreme caution and care should be taken to avoid damaging the weather resistive barrier (WRB). To avoid tearing, try to keep the WRB tight to the corner.

Section
Number

Title

- N. The size of the casing bead and other accessories shall be compatible with the thickness of the plaster that is to be applied. For traditional $\frac{3}{4}$ inch stucco work, these accessories shall be $\frac{3}{4}$ inches. Smaller sizes may be used with listed stucco products.
- O. Lath is to terminate above stoops and other concrete flatwork. Framing must be protected from pouring concrete directly against it.
- P. Owner requires the use of foundation weep screeds. The purpose of the weep screed is to allow any water that may be flowing across the drainage membrane a means to escape. There are some architectural details which show how a casing bead may be utilized as a weep screed when applied over both layers of paper.

Stucco Application

- A. A three-coat stucco system shall consist of a separate scratch, brown, and finishing coat with a total thickness of $\frac{7}{8}$ ".
- B. Owner recognizes alternative materials and methods of construction. Products that have received an evaluation report and number from the ICC-Evaluation Service would fall under the category of "alternative materials". There are several proprietary "one coat" products that have a ICC-Evaluation Service listing. Typically, these products come premixed, and when applied according to the manufacturer's installation instructions, they may be applied in one coat with a second topcoat being applied at a later time.
- C. Stucco wall covering of any kind shall not be applied until the drywall and roofing materials have been installed. This allows loading of the wall systems as well as eliminating any hammering on the exterior walls that could potentially cause cracking to occur.
- D. There are several types of acceptable topcoats. Some are a portland based finish, acrylic, elastomeric, and latex. The contractor should be aware of potential incompatibility between some of the finishes and the base coat(s) due to the alkalinity of the stucco.

Weatherproofing and Application of Sealants

- A. Backer rod limits the depth of the caulk. The depth of a caulk joint should not exceed its width. The minimum width of a caulk joint should be $\frac{1}{4}$ ". This is the most watertight type of caulk joint.

Section
Number

Title

- B. The ability of the joint to flex and remain adhered is greatly influenced by the type of caulking material used. A good quality acrylic-latex shall be used for some applications that are less critical. For joints where water sealing is critical, or difficult to access, the use of a better material such as urethane or silicon will be used.
- C. It is recommended that all joints between dissimilar surfaces in a stucco wall be caulked. This would include, but not be limited to, windows to wood trim, wood trim to stucco (wraps, corners, bands, etc.). Do not caulk metal head flashings, z-bar flashing, or anywhere water would normally escape the wall.

****END OF SECTION****

Section Number	Title
09 30 00	TILING
09 30 13	Ceramic Tiling

Part 1 – General

Ceramic tile products should be specified that can endure high impact, low water absorption rates, and have low dimensional and color variations per order.

Floor Tile sizes are pending approval from project manager, but shall have matte finish (abrasive finish if exterior or lobby applied), and comply with current ADA and Building Code requirements and the following requirements:

Floor

- Through color, 3/8" minimum thickness;
- Cove tile bases shall be used in all restroom applications;
- Tile inserts or accents in a predominantly matte or abrasive finish field may be polished or glazed;
- Grout joints should not exceed 1/8". On flooring, a dark grout shall be specified.

Wall

- Minimum wall tile dimensions shall be 4" x 4" x 5/16" (unless a mosaic design is anticipated, which case the minimum dimensions will be 2" x 2"), and comply with the following requirements:
- Restrooms to be glazed, flat tile, thick-set on wet wall(s), thin-set other. Tile shall be full height on the wet wall(s).
- Grout joints should not exceed 1/16";
- Interior walls other than restrooms (glazed only) may be glazed or matte finish.

A color of tile and grout should be chosen that is easily maintainable and repairable. Epoxy mortars and grouts shall be used in all exterior applications, wet locations, areas subject to heavy traffic and areas that may come into contact with solvents, chemicals or continuous immersion in water.

Tile used on step treads shall have an abrasive finish or receive a rough finish imbed a minimum of 2" wide at the stair nosing, running the length of the tread.

Part 2 - ProductProduct Extra

Contractor must provide an appropriate amount of product extra stock (minimum 10%) of each color and style of tile to be turned over to Owner for future repairs prior to project closeout.

Section
Number Title

Part 3 – Execution

N/A

****END OF SECTION****

Section Number	Title
09 50 00	CEILINGS
09 51 00	Acoustical Ceilings

Part 1 – General

N/A

Part 2 – Products

24" x 24" or 24" x 48" x ¾" thick, mineral fiber or noncombustible fiberglass panels, not less than 2" thick.

Minimum NRC factor of 0.65 to 1.00, minimum STC rating of 50, minimum reflectance 75%.

Concealed ceiling grid systems are not acceptable.

Part 3 – Execution

Contractor must provide a 2% extra stock material, over actual area used, of each color, size and style.

Suspension grid to be 15/16" thick exposed or regular, medium or heavy duty T type.

Lighting, diffusers, and sprinklers should be designed to occur in the system at regular or predetermined intervals. Fire Sprinkler heads shall be located in the center of a tile. Require sub-trades to locate ceiling penetrations in locations that are the center of a panel.

No stud walls are to run to the underside of the ceiling grid acoustical system.

All ceiling grid layouts are to be centered in the room, with no less than 6" cut tile at the perimeter of the room. If the ceiling grid cannot be centered in a room for other architectural or building systems reasons, layout is to be approved by NAU project manager.

Surface texture(s) should offer low maintenance, can be cleaned periodically, and are readily available. Pattern should be in-stock, non-special order.

****END OF SECTION****

Section Number	Title
09 60 00	FLOORING
09 62 00	Specialty Flooring
09 62 23	Bamboo Flooring
	<u>Part 1 – General</u>
	While Owner understands the sustainable benefits of bamboo flooring, it is prohibited for use.
	<u>Part 2 – Products</u>
	N/A
	<u>Part 3 – Execution</u>
	N/A
09 65 00	Resilient Flooring
	<u>Part 1 – General</u>
	N/A
	<u>Part 2 – Products</u>
	Linoleum sheet goods generally are not acceptable. Exception to this is that sheet goods may be specified for areas in temporary or modular buildings requiring them per health department regulations.
	<u>Part 3 – Execution</u>
	N/A
09 65 13	Resilient Base and Accessories
	<u>Part 1 – General</u>
	N/A
	<u>Part 2 – Products</u>
	When a composition base material is utilized, it is to be a rubber base rather than vinyl. All outside corners shall be pre-formed, Base shall be 4" x 1/8" cove base, dark in color (to hide impact marks), matte finish.
	Carpet base is acceptable if appropriate for the project.
	<u>Part 3 – Execution</u>
	Exposed or junction edges of the tile shall receive vinyl or aluminum reducer strips.

Section Number	Title
09 65 19	Resilient Tile Flooring

Part 1 – General

Tile shall be applied with suitable waterproof mastic. In the event of existing tile in the area, DP shall specify removal and suitable preparation for application of new surface.

Part 2 – Products

Tile shall be a minimum of 12" x 12" x 1/8" Composition 1, asbestos free, rated as heavy duty commercial. A minimum of two percent or one box of product as extra for maintenance purposes required. Product extra requirements apply to each type/color or product if more than one is specified. Product should be scratch-resistant.

Part 3 – Execution

N/A

09 66 00	Terrazzo Flooring
-----------------	--------------------------

Part 1 – General

Installers shall be limited to companies specializing in full bed terrazzo applications with documented experience and a member of the National Terrazzo and Mosaic Association and have a minimum of 5 years relative experience in size and scope similar to the project.

Part 2 – Products

Total terrazzo minimum thickness not less than 3/4".

Reinforcing mesh, minimum 2" x 2" x 16 gauge, galvanized should be specified.

Aluminum oxide non-slip aggregate to match surface aggregate should be specified.

Control and divider strips shall be 1/4" width, zinc topped, recommended maximum placement not exceeding 8'x8'.

An aggregate and matrix color should be chosen that is easily maintainable.

Cove terrazzo bases shall be used where terrazzo is used as a flooring material.

1/4" sand cushion is recommended over the structural floor substrate.

Section
Number

Title

Terrazzo used on step treads shall be grooved or have a rough finish imbed with a minimum of 2" wide at the stair nosing, running the length of the tread.

Part 3 – ExecutionN/A**09 68 00****Carpeting**Part 1 – General

Selection of broadloom carpet and/or carpet tile shall be discussed with Owner's Project Manager. Carpet tile is preferred over broadloom.

Carpet tile is acceptable in some applications; minimum requirements are same as broadloom carpet above. Factory applied carpet tile is required for removable computer raised floor systems. Carpet tile to be the same size as the removable floor panel. Contractor to provide the required claw and/or tool to remove the floor panel and carpet as one unit.

A color and pattern should be specified that is easily maintainable.

A seaming diagram, if using broadloom, must be submitted prior to carpet purchase, for review by Owner. For carpet tile, if a floor pattern with different color and patterned carpet tile is being considered, a submittal of the carpet pattern is required for Owner approval.

1% - 5% additional material over actual area used (depending on size of project) shall be provided.

All firms that will bid this section must have a minimum of not less than 5 years of carpeting installation experience, similar to the size and scope contained in the project.

All carpet must conform to the Owner's sustainability requirements. Carpet shall have a high recycle content. All demolished carpet to be recycled when renovations occur. Contact Owner Sustainability Program Manager for additional information. Carpet tile with lower recycled content may be accepted if it can be verified as compliant with material health protocols such as Cradle to Cradle or Living Building Challenge.

Part 2 – Products

The standards set by Owner are for all parties involved to meet the minimum requirements below. Quality and style of carpet is to be selected to meet the service requirements of the area.

Section
Number

Title

Throughout the project, carpet shall be of the same type and manufacturer.

Minimum Performance Requirements:

Yarn

100% first quality, Type 6 or 6,6 bulk continuous filament (BCF) nylon offering a construction and performance standards testing program by fiber producer. Yarn Modification Ratio must meet a 1.8 or less. Mill extruded nylon is prohibited.

Static Control

By permanent means (i.e. antistatic filaments) and without chemical treatment, static generation below 3.0 kilovolts. Electrostatic Propensity (Step): AATCC 134. For any areas with computers, static generation, should be below 2.0 km.

Dye Method

100% Solution dyed.

Carpet Tile Pile Weight

Shall be a minimum of 17 oz/yd² per ASTM D5848-07, maximum 24 oz per yard (lower face weights are preferable if equal or superior performance can be substantiated by Texture Appearance Retention Testing).

Broadloom Pile Weight

Shall be a minimum of 24 oz/yd².

Pile Density

The density shall be a minimum of 7,000 oz/cubic yard for heavy traffic areas and 8,000 extreme traffic areas. Pile density = 36 x pile wt(oz./sq yd)/ pile thickness (inches) (Pile Thickness: ASTM D6859 or ASTM D7241).

Gauge

Shall be a minimum of 1/12 inch.

Dimensional Stability

Aachen method/ISO 2551, Maximum Change +/- 0.20%.

Flammability

ASTM 648, >0.45 watts/cm² critical radiant flux and/or federal, state or local requirements.

Smoke Density

Section
Number

Title

ASTM E662 Rating to be less than 450 Dm in flaming mode (or to State Code). Must meet Federal Flammability standard CPSC FF1-70 (Methenamine Pill test ASTM D2859).

Colorfastness to Light

AATCC 16 part 3, 80 AFU, AATCC Gray Scale for Color Changing rating of 4 or better.

Colorfastness to atmospheric contaminants

AATCC 164 (oxides of nitrogen) and AATCC 129 (ozone) for 2 cycles, AATCC Gray Scale for Color Change rating of 4 or better.

Wall Base

4" x 1/8" covered rubber bases, dark in color to hide impact marks, matte finish. Carpet base is acceptable if appropriate for the project.

Colorfastness to crocking

AATCC 165, minimum rating of 4 on AATCC Chromatic Transference Scale.

Resistance to Delamination

ASTM D3939 minimum 4.0lbs/inch

Primary Backing

100% woven or non-woven synthetic.

Secondary Backing

Vinyl or urethane backing system or equivalent.

Stain Resistance

AATCC 171 (HWE) for 2 washings to simulate removal of topical treatments by hot water extraction, followed by AATCC 175. Minimum rating of 8 using AATCC Red 40 Stain Scale. The stain resistive properties must be inherent, topical stain resistant treatments will not be acceptable, properties must not be able to be removed by commercial cleaning or abrasive wear.

Coloration

Minimum 5 color hues. Hue values to be in medium to medium-dark range for optimum soil hiding capability.

Appearance Retention

Vettermann Drum Test, ASTM D5417 for 22,000 cycles. A minimum rating of 3.0 using CRI-3 Loop Pile Reference Scale. Testing without underpad or brushing.

Section
Number

Title

Environmental Requirements

Products must be NSF 140 Platinum as certified by third party. Carpet manufacturer must supply certificate as part of the procurement documentation.

Indoor Air Quality

Maximum 0.5 mg/m²hr total VOC emission per ASTM D5116. Meet CRI Green Label Plus certification. The carpet and floor adhesive (for glue-down installations) must meet the Green Label Plus (GLP) and floor adhesive (for direct glue down) requirements of the Carpet and Rug Institute (CRI). GLP number must be provided. Carpet and all installation components including adhesives, sealers, seam welds and seam sealers must meet the Low Emitting Materials standards as outlined in U.S. Green Building Council LEED criteria.

Recycling

New Carpet: Carpet must be eligible for recycling by the supply mill or fiber producer to an existing operational third party certified recycling center; submit program parameters. Landfills are not an option.

Used Carpet

Remove carpet and recycle regardless of manufacturer, fiber type or construction. Reclamation Agency and Carpet Remover shall certify in writing the used carpet was removed and recycled. Landfills are not an option. Recycle content of the total product weight must be either pre-consumer or post-consumer content or a combination of:

- Broadloom – minimum of 10%
- Modular Tile – minimum of 30%

Installation Method

No wet adhesives as approved by manufacturer.

Warranties

- Wear: Warrant that the carpet will lose no more than 10% by weight of pile face fiber during the life of the carpet when installed and maintained in accordance with manufacturer's procedures.
- Static Protection: warrant that the carpet will give protection from static discharge in excess of 3.0 KV when tested under the standard Shuffle Test Method (at 70 degrees F and 20% R.H.) during the Life of the Carpet.
- Backing De-lamination: Warrant that the secondary backing of the carpet will not de-laminate during the life of the carpet.
- Edge Ravel: Warrant that under normal use, the carpet will not ravel at the seams or at the edge during the life of the carpet. Seam sealers or seam

Section
Number

Title

welds should not be required for warranties.

- No dimensional instability (i.e., shrinkage, curling and doming) which adversely affect the ability of the tile to lie flat.
- Specify that a special project warranty from the installer of a minimum of a 2-year full warranty to fix, repair or replace carpeting failure as the result of defective workmanship.

Substitutions

Substitutions will be considered when a written request has been submitted Owner following Division 0 Substitution Procedures. It is the sole responsibility of the party submitting the alternate to include complete descriptive and technical information, along with a physical sample, so a complete evaluation can be made. No substitutions without prior written approval will be permitted.

Approved Carpet Manufacturers

Owner will consider any manufacturer that will offer products matching above minimum requirements.

Part 3 – Execution

Protection

It must be the contractor's responsibility to protect all furniture, walls, doors, etc. from any damages during installation of carpet and base, and removing existing carpet and base where applicable. Any items moved shall be replaced in original position. The Contractor will be responsible for all damages.

Job Conditions

Installer must examine the substrate and conditions under which the carpeting is to be installed, and notify the contractor, in writing, of conditions detrimental to the proper and timely completion of the work.

Carpet Finish

Carpet shall have metal or vinyl carpet reducers at juncture with other material or at entrances.

****END OF SECTION****

Section Number	Title
09 70 00	WALL FINISHES
09 72 00	Wall Covering

Part 1 – General

N/A

Part 2 – Products

- A. A special project warranty is required from the installer of a minimum of a 2 year full warranty to fix, repair or replace covering failure as the result of defective workmanship.

Part 3 – Execution

- A. Installers must have a minimum of 3 years of wall covering experience, similar to the size and scope contained in the project.
- B. Two full rolls of same size material used shall be provided for maintenance stock.

****END OF SECTION****

Section Number	Title
09 90 00	PAINTING AND COATING
09 91 00	Painting

Part 1 - General

Paint products provided should be locally available, in order to minimize attic stock, unless special permission is granted by Owner (Paint department).

Low VOC paint shall be used, with a preference for NO VOC containment.

DP shall specify ventilation and isolation requirements to avoid complaints regarding noxious fumes.

All paint material required per the scope of work for a project is to be bid and purchased by awarded contractor. Owner will not be purchasing paint material for any projects.

Part 2 – Products

All paint materials shall be manufacturers' premium grade product. Products may be submitted for approval to the Owner/DP.

Insofar as possible, all components of the paint system shall be products of the same manufacturer.

Part 3 – ExecutionDelivery and Storage

Deliver materials to job site in original, new and unopened packages and containers bearing manufacture's name, paint identification, formula number, batch number, etc. with labels intact.

Job Conditions

Coatings shall be applied in accordance with the manufacturer's printed directions for the paint used. Special attention will be given to applying a coating when temperature, humidity, and other weather factors are acceptable by the manufacturer and/or owner. No paint shall be applied until preceding coat has dried. Successive coats shall have colors varied by tinting sufficiently to permit easy visual check of the coverage unless otherwise stated.

The Owner reserves the right to take samples of materials for chemical analysis; to assess wet or dry film thickness; or to utilize any other standard inspection procedures necessary to assure quality and compliance with requirements of the Contract Documents.

Section
Number Title

Submittals

The contractor shall submit specifications for proposed products for approval prior to application.

Close-out requirements shall include:

- product extra requirements of a minimum of one gallon, from the same batch of each color and each type of paint used on the project. Gallon cans shall be labeled with manufacturer’s name, color name & formula.
- a typed list, by area, of paint used including: manufacturer, year purchased, color name, finish type (Satin, semi-gloss etc.) and formula.

An exception to this is projects that have multiple colors, 4”x4” color cards may be accepted, including color reference, project name and number at the back of each card.

09 91 13 Exterior Painting

Part 1 – General

All paint schedules shall be provided to Owner prior to work commencing.

Part 2 – Products

Provide the following coating systems for substrates indicated. Apply each material at the coverage rate required to produce the total composite dry film thickness (DFT) indicated. Materials containing low solids content by volume shall be applied in multiple coats as required to build specified DFT.

Primers are not required on substrates specified to be factory primed under other sections unless required as a bond coat.

Galvanized Steel	1st Primer	Best Quality Exterior Latex Primer	1.5
	2nd Coat	Best Latex Exterior SG or Flat	1.5
	3rd Coat	Best Latex Exterior SG or Flat	<u>1.5</u>
		Total Mil Thickness	4.5
Ferrous Metal	1st Primer	Best Exterior Primer for System	1.5
	2nd Coat	Best Exterior Primer for System	1.5
	3rd Coat	100% Solids Urethane Semi Gloss	<u>4.0</u>
		Total Mil Thickness	7.0
Exterior Stucco	1st Coat	Best Exterior Latex Primer	2.0
	2nd Coat	Best Exterior Latex Flat	<u>2.0</u>
		Total Mil Thickness	4.0

Section Number	Title		
	Exterior Wood	1st Primer	Best Exterior Latex Primer 1.5
		2nd Coat	Best Exterior Latex SG or Flat 1.5
		3rd Coat	Best Exterior Latex SG or Flat <u>1.5</u>
		Total Mil Thickness	4.5
	Exterior Wood	1st Coat	Best Quality Exterior Transparent Stain*
		2nd Coat	Best Quality Exterior Transparent Stain*
	* No film build requirement, just even coloration		

09 91 23

Interior Painting

Part 1 – General

All paint schedules shall be provided to Owner prior to work commencing.

Part 2 – Products

Provide the following coating systems for substrates indicated. Apply each material at the coverage rate required to produce the total composite dry film thickness (DFT) indicated. Materials containing low solids content by volume shall be applied in multiple coats as required to build specified DFT.

Primers are not required on substrates specified to be factory primed under other sections unless required as a bond coat.

Concrete, Plaster, or Gypsum Wallboard	1st Primer	Best Quality Latex Primer	1.5
	2nd Coat	Best Quality Latex Semi Gloss	1.5
	3rd Coat	Best Quality Latex Semi Gloss	<u>1.5</u>
	Total Mil Thickness		4.5
Ferrous Metal	1st Primer	Best Quality Primer	1.5
	2nd Coat	Best Quality Primer	1.5
	3rd Coat	Best Alkyd or Latex Finish Coat	<u>2.0</u>
	Total Mil Thickness		5.0
Galvanized Metal	1st Primer	Best Quality Latex Primer	1.5
	2nd Coat	Best Quality Latex Primer	1.5
	3rd Coat	Best Alkyd or Latex SG or Flat	<u>1.5</u>
	Total Mil Thickness		4.5
Wood	1st Primer	Best Quality Latex Primer	1.5
	2nd Coat	Best Quality Latex SG or Flat	1.5

Section Number	Title	
	3rd Coat	Best Quality Latex SG or Flat Total Mil Thickness
		1.5 4.5

Note: These paint systems are general in nature. They may not apply to special job requirements and may be changed prior to bid acceptance. Specifications will be provided in writing in the event of a change.

General: Perform preparation and cleaning procedures in accordance with paint manufacturer's instructions and as herein specified, for each particular substrate condition.

Remove or protect hardware, hardware accessories, machined surfaces, plates, lighting fixtures, and similar items that are not to be painted to insure that no paint is applied to these surfaces. Reinstall or remove protection upon completion of painting of the adjacent surfaces.

Clean surfaces to be painted before applying paint or surface treatments. Remove oil and grease prior to mechanical cleaning. Program cleaning and painting so that contaminants from cleaning process will not fall onto wet, newly-painted surfaces.

Wood: Clean wood surfaces to be painted of dirt, oil, or other foreign substances with scrapers, mineral spirits, and sandpaper, as required. Sand paper smooth those finished surfaces and dust off. Scrape and clean small, dry, seasoned knots and apply a thin coat of white shellac or other recommended knot sealer, before application of priming coat. After priming fill holes and imperfections in finish surfaces with putty or plastic wood-filler. Sandpaper smooth when dried.

Prime, stain, or seal wood required to be job-painted. Prime edges, ends, faces, undersides, and backsides of such wood.

Seal tops, bottoms and cut-outs of un-primed wood doors with a heavy coat of varnish or equivalent sealer.

Ferrous Metals: Clean ferrous surfaced, which are not galvanized or shop-coated, of oil, grease, dirt, loose mill scale and other foreign substances by solvent or mechanical cleaning.

Galvanized Surfaces: Clean free of oil and surface contaminants with non-petroleum based solvent and apply pre-wash or bond coat as indicated.

Section
Number

Title

APPLICATION

General: Apply paint in accordance with manufacturer's directions. Use applicators and techniques best suited for substrate and type of material being applied. Understand and honor all applicable OSHA safety and local, State or Federal VOC requirements.

Apply additional coats when undercoats, stain or other conditions show through final coat of paint, until paint film is of uniform finish, color and appearance. Give special attention to insure that surfaces, including edges, corners, crevices, welds, and exposed fasteners receive a dry film thickness equivalent to that of flat surfaces.

Paint surfaces behind movable equipment and furniture same as similar exposed surfaces. Paint surfaces behind permanently-fixed equipment or furniture.

Paint interior surfaces of ducts, where visible through registers or grilles, with a flat black paint.

Paint back sides of access panels, and removable or hinged covers to match exposed surfaces.

Finish exterior doors on tops, bottoms and side edges same as exterior faces, unless otherwise indicated.

Sand lightly between each succeeding enamel or varnish coat.

Scheduling Painting: Apply first-coat material to surfaces that have been cleaned, pre-treated to otherwise prepared for painting as soon as practicable after preparation and before subsequent surface deterioration.

Allow sufficient time between successive coats to permit proper drying. Do not re-coat until paint has dried and application of another coat will not cause lifting and loss of adhesion of the undercoat.

Minimum Coating Thickness: Apply materials at not less than manufacturer's recommended spreading rate, to establish a total dry film thickness as indicated or, if not indicated, as recommended by coating manufacturer.

Prime Coats: Apply prime coat to material which is required to be painted or finished, and which has not been prime coated previously. Recoat primed and sealed surfaces where there is evidence of suction spots or unsealed areas in

Section
Number

Title

first coat, to assure a finish coat with no burn-through or other defects due to insufficient sealing.

Stipple Enamel Finish: Roll and redistribute paint to an even and fine texture. Leave no evidence of rolling such as laps, irregularity in texture, skid marks or other surface imperfections.

Pigmented (Opaque) Finishes: Completely cover to provide an opaque, smooth surface of uniform finish, color, appearance and coverage. Cloudiness, spotting, holidays, laps, brush marks, runs, sags, ropiness or other surface imperfections will not be acceptable.

Metal doors and hollow metal door and window frames shall be spray painted unless otherwise stated.

Transparent and Semi-Transparent: Use multiple coats to produce glass-smooth surface film of even luster. Provide a finish free of laps, cloudiness, color irregularity, runs, brush marks, orange peel, nail holes, or other surface imperfections. Provide satin finish for final coats, unless otherwise indicated.

Completed Work: Match approved samples for color, texture and coverage. Remove, refinish or repaint work not in compliance with specified requirements.

CLEAN-UP AND PROTECTION

Clean-Up: During progress of work, remove from site discarded paint materials, rubbish, cans and rags at end of each work day. Contractor will furnish his own trash receptacles and removal. Contractors will not use NAU trash containers unless approval is granted.

Upon completion of painting work, clean window glass and other paint-splattered surfaces. Remove splattered paint by proper methods of washing and scraping, using care not to scratch to otherwise damage finished surfaces.

Protection: Protect work of other trades, whether to be painted or not, against damage by painting and finishing work. Correct and damage by cleaning, repairing or replacing, and repainting, as acceptable to Design Professional.

Provide "Wet Paint" signs as needed to protect newly-painted finishes. Remove temporary protective wrappings provided by others for protection of their work, after completion of painting operations. At the completion of work of other trades, touch-up and restore all damages to painted surfaces.

Section Number	Title
09 96 00	High-Performance Coatings
09 96 13	Abrasion-Resistant Coatings
	<u>Part 1 – General</u> Floorings at entrances and entry walls shall be an easily maintained, non-slip surface when wet.
	<u>Part 2 – Products</u> N/A
	<u>Part 3 – Execution</u> N/A
09 96 23	Graffiti Resistant Coatings
	<u>Part 1 – General</u> Application of graffiti-resistant coatings is discouraged because of potential difficulties in future maintenance, however, it is recognized that in some instances a clear anti-graffiti coating may be necessary to provide protection of certain exterior façade materials, such as stone.
	<u>Part 2 – Products</u>
	A. Graffiti-resistant coating shall be permanent and shall not require re-application upon removal of graffiti.
	B. Graffiti-resistant coating shall leave the finished surfaces uniform in appearance and not alter the natural color and texture of the material to which it is applied.
	C. The DP shall submit a sample of the graffiti-resistant coating applied to the intended substrate material at the final schematic design submittal.
	<u>Part 3 – Execution</u> N/A
09 96 53	Elastomeric Coatings
	<u>Part 1 – General</u> Elastomeric coating is not authorized by Owner.

Section
Number

Title

Part 2 – Products

N/A

Part 3 – Execution

N/A

09 97 00

Special Coatings

09 97 35

Dry Erase Coatings

Dry Erase Coatings, also known as white board paint, is not authorized by Owner. The use of physical white boards/fixed dry markerboards is recommended and detailed in the Design Guidelines.

****END OF SECTION****

DIVISION 10 - SPECIALTIES

Section Number	Title
10 10 00	INFORMATION SPECIALTIES
10 11 00	Visual Display Units
10 11 13	Chalkboards
10 11 16	Marker boards
10 11 23	Tack boards
10 11 33	Sliding Visual Display Units
10 14 00	Signage
10 14 16	Plaques
10 17 00	Telephone Specialties
10 20 00	INTERIOR SPECIALTIES
10 21 00	Compartments and Cubicles
10 21 13	Toilet Compartments
10 21 13.13	Metal Toilet Compartments
10 21 13.16	Plastic-Laminate-Clad Toilet Compartments
10 22 00	Partitions
10 22 26	Operable Partitions
10 26 00	Wall and Door Protection
10 26 13	Corner Guards
10 28 00	Toilet, Bath, and Laundry Accessories
10 28 13	Toilet Accessories
10 28 16	Bath Accessories
10 30 00	FIREPLACES AND STOVES
10 31 00	Manufactured Fireplaces
10 40 00	SAFETY SPECIALTIES
10 44 00	Fire Protection Specialties
10 44 13	Fire Protection Cabinets
10 50 00	STORAGE SPECIALTIES
10 51 00	Lockers
10 51 13	Metal Lockers
10 56 00	Storage Assemblies
10 56 16	Fabricated Wood Storage Shelving
10 57 00	Wardrobe and Closet Specialties
10 57 23.16	Plastic-Laminate-Clad Closet and Utility Shelving
10 70 00	EXTERIOR SPECIALTIES
10 73 00	Protective Covers
10 73 26	Walkway Coverings

DIVISION 10 - SPECIALTIES

Section Number	Title
10 75 00	Flagpoles

DIVISION 10 - SPECIALTIES

Section Number	Title
10 10 00	INFORMATION SPECIALTIES

10 11 00	Visual Display Units
-----------------	-----------------------------

Part 1 - General

Consult with Owner (NAU Project Manager) if visual display units are to be part of the construction documents or will be provided by others. Provide sufficient blocking to support visual display unit as part of the construction documents.

Part 2 – Products

The minimum vertical writing surface per room shall be not less than 32 s.f. 64 s.f. is the standard for classroom spaces. All vertical writing surfaces shall have a continuous tray at the base for markers and erasers. They shall also have a top 1” cork strip.

One set of markers and one eraser shall be included with every 8’ of marker board. Map clips are optional, depending on the user’s needs.

If there is an intent to use the visual board as a projection surface, care must be exercised to ensure that the height of the marker board is sufficient to serve this purpose

Any individual unit shall not be larger than 16’ long.

Part 3 – Execution

SUBMITTALS

Product Data: Submit product data and installation instructions, including manufacturer’s SPEC-DATA product sheet, for specified products.

Shop Drawings: Submit shop drawings for each type of visual display board required, showing layout, profiles and product components, including anchorage, accessories, finish colors, patterns and textures.

Samples: Submit selection and verification samples of face, core, backing material and trim for finishes, colors and textures. Submit manufacturer’s color charts.

Quality Assurance/Control Submittals: Submit the following:

- Certificates: Product certificates signed by manufacturer certifying materials comply with specified performance characteristics and criteria and physical

DIVISION 10 - SPECIALTIES

Section
Number

Title

requirements.

- Closeout Submittals: Submit the following:
 - Operation and Maintenance Data: Submit operation and maintenance data for installed products in accordance with Division 1 Closeout Submittals (Maintenance Data and Operation Data) Section.

QUALITY ASSURANCE

- Installer Qualifications: Installation contractor shall be experienced in performing work of this section and have specialized in installation of work similar to that required for this project.
- Regulatory Requirements: Conform to applicable code for flame/smoke rating in tack boards in accordance with current fire codes.

DELIVERY, STORAGE AND HANDLING

- Ordering: Comply with manufacturer's ordering instructions and lead-time requirements to avoid construction delays.
- Delivery: Deliver materials in manufacturer's original, unopened, undamaged containers with identification labels intact.
- Deliver materials wrapped in moving blankets and/or corrugated product and secured to freight trailer with straps to ensure minimal movement.
- Deliver factory built units completely assembled in 1 piece without joints whenever possible. Where dimensions exceed panel size, provide 2 or more pieces of equal length as acceptable at the factory, disassemble for delivery, and make final joints at the jobsite per manufacturer's installation instructions.
- Storage and Protection: Store materials protected from exposure to harmful weather conditions and at temperature and humidity conditions recommended by manufacturer.
- After opening and inspecting boards for damage, return them to their original crates or cartons for storage and do not uncrate until boards are to be installed.
- When uncrated, do not allow boards to lean at an angle against a wall or other objects, or to lie on the floor for any length of time.

DIVISION 10 - SPECIALTIES

Section
Number

Title

- Store boards in as close to a vertical position as possible.

PROJECT CONDITIONS

- Environmental Requirements: Comply with manufacturer's recommendations for stabilizing area to the approximate normal occupied conditions of interior temperature and humidity.
- Existing Conditions:
 - Verify actual dimensions by field measurement before fabrication; show recorded measurements on shop drawings.
 - Coordinate field measurements and fabrication schedule with construction progress to avoid construction delays.

WARRANTY

- Manufacturer's Warranty: Submit, for Owner's acceptance, manufacturer's standard warranty document executed by authorized company official. Manufacturer's warranty is in addition to, and not a limitation of, other rights Owner may have under Contract Documents.
- Submit a Warranty, stating that under normal usage and maintenance, and when installed in accordance with manufacturer's instructions and recommendations.
- Warranty Period:
 - Life time warranty for writing surface, commencing on Date of Substantial Completion
 - 10 year warranty on material commencing on Date of Substantial Completion.
 - 2-year warranty on workmanship commencing on Date of Substantial Completion.

10 11 13

Chalk boards

Chalk boards are not to be specified unless there is a specific need and approved by Owner.

10 11 16

Marker boards

Part 1 – General

This section pertains to fixed, modular-support-mounted, rail-mounted and portable marker boards

Dry erase marker boards, also known as white boards, shall be:

Environmental ceramic-steel surface with controlled, continuous coil-coating, and ceramic finish fused to a steel core.

Color of finished face shall be white, non-glare matte type finish.

DIVISION 10 - SPECIALTIES

Section Number	Title
	<p>Fabricated frames and trim shall be clear anodized aluminum, not less than 0.062" or as specified by the user group. Marker trays shall be aluminum, solid extrusion with a ribbed section, with smoothly curved ends.</p> <p>Fixed-height whiteboards should be mounted with the bottom edge at 36" AFF.</p> <p>For any other writing surface type, for example glass boards and porcelain boards, submittals are to be provided for review and approval by the Owner. White board paint is not acceptable.</p> <p><u>Part 2 – Products</u> N/A</p> <p><u>Part 3 – Execution</u> N/A</p>
10 11 23	<p>Tack boards</p> <p>Cork tack boards shall have a single layer, 1/4" thick, seamless, compressed fine grain natural cork sheet, sanded for a natural finish, and self-healing complying with MS MIL-C-15116, Type II. Fabric covered tack boards are acceptable.</p>
10 11 33	<p>Sliding Visual Display Units</p> <p>Operable Board Units shall comply with section 10 11 16, Marker boards.</p>
10 14 00	<p>Signage</p> <p><u>Part 1 – General</u> Exterior Signs All exterior signs shall conform to the specifications of the Northern Arizona Signage Policy. Ask Owner for current design standards and requirements.</p> <p>Interior Signs All interior signs shall conform to the current specifications of the Northern Arizona Signage Policy. Ask Owner for current design standards and requirements.</p> <p><u>Part 2 – Products</u> N/A</p> <p><u>Part 3 – Execution</u> N/A</p>

DIVISION 10 - SPECIALTIES

Section Number	Title
10 14 16	<p>Plaques</p> <p><u>Part 1 – General</u> The standard size for plaques varies. The lettering Style shall be either Times Roman Bold, (Times Roman Bold), or Palentino Bold, (Palentino Bold) Display: Letters should be upper and lower case. Text should be bordered with a border proportionate to the size of the plaque i.e. 1/4" for an 8" x 10" plaque, 1/2" for an 18" x 24" plaque. Letters and border should be raised and polished, background should be brown pebbled.</p> <p><u>Part 2 – Products</u> N/A</p> <p><u>Part 3 – Execution</u> Proofs: The President's approval of proofs/rubbings for plaques is required prior to final casting or etching.</p> <p>Material: Exterior plaques - Bronze is preferred, brass is acceptable. Interior plaques - Bronze, brass or aluminum is acceptable.</p> <p>Fastening: Concealed threaded studs on back of plaque. Setting should be in grout or epoxy.</p>
10 17 00	<p>Telephone Specialties Refer to Division 27</p>

DIVISION 10 - SPECIALTIES

Section Number	Title
10 20 00	INTERIOR SPECIALTIES
10 21 00	Compartment and Cubicles For information on copy rooms and custodial closets refer to Division 13.
10 21 13	Toilet Compartments <u>Part 1 - General</u> All toilet compartments products accessory items, colors, finish applications and details are to be reviewed and approved by Owner prior to final development of construction documents. Field verify all locations and dimension of all units to be installed prior to installation. At group toilet rooms, provide toilet partitions at each toilet and urinal screens at each urinal. Provide privacy screens at showers according to program requirements. Door hardware, anchorages and accessories shall be per manufacturer's recommendation per finish type selection and heavy-duty, and incorporate the following: <ul style="list-style-type: none">• Doors shall be self-closing• Hinges shall be continuous stainless steel, mounted at doors and pilasters with fasteners at 8 inches on center. Gravity/cam or integral hinges are not permitted.• Doors shall be furnished complete with necessary wall bumpers, door pulls, heavy duty door strikes, keepers and latch housings.• Verify accessibility requirements for door widths and stall sizes.• Fasteners shall be stainless steel, tamperproof one-way bolts or anti-theft torx screws throughout installation. Wall connections shall be plastic anchors, lead anchors or toggle bolts as require by field conditions.
10 21 13.13	Metal Toilet Compartments <ul style="list-style-type: none">• Floor-to-wall mounting preferred• Metal partitions shall not be painted• Stainless steel textured partitions are acceptable. Stainless Steel smooth partitions are not acceptable.
10 21 13.16	Plastic-Laminate-Clad Toilet Compartments <ul style="list-style-type: none">• Floor-to-wall mounting preferred• A random pattern is preferred to solid colors (to extend time when discoloration from repetitive cleaning becomes obvious). Finish and color must be approved by Owner.

DIVISION 10 - SPECIALTIES

Section Number	Title
10 21 13.19	<p>Plastic Toilet Compartments</p> <ul style="list-style-type: none">• Floor-to-ceiling or floor-to-wall. Floor to wall mounting is preferred.• High Density Polyethylene (HDPE) preferred.• A random pattern is preferred to solid colors, and uniform throughout• Finish and color must be approved by NAU Project Manager• Panels shall have a 1" minimum thickness• Edges shall be machined to a ¼" radius with sharp corners removed.
10 22 00	Partitions
10 22 26	<p>Operable Partitions</p> <p><u>Part 1 - General</u></p> <p>Operable partitions used to functionally and acoustically separate large areas of general use space, consisting of floor to ceiling stackable panels on a track system shall meet the following:</p> <ul style="list-style-type: none">• Minimum STC composite rating of 50, tested on 100 sf. opening.• Minimum in field performance equal or better than ASTM E336.• Installed track deflection under full load no greater than 1/360.• Minimum panel thickness shall be 4 inch, panel skins rated Class A, in full perimeter protective steel frame.• Vertical sound seals between panels will be tongue and groove, consisting of steel astragals incorporating vinyl acoustical seals.• Horizontal top seals shall be twin-finger continuous contact type. Mechanical bottom seals shall be made of formed steel, incorporating 1/4 inch vinyl strips for proper acoustical seal when activated.• Hinges on panels and inset pass doors are recessed and project no more than 1/4 inch beyond panel face.• Footbolts and stabilizers shall be internal and edge activated. No protruding footbolts attached to panel faces are allowed.• Suspension system shall consist of a steel track connected to structural support by threaded rods. Each panel of a paired assembly shall be supported by one carrier assembly consisting of steel ball bearing wheels. Each panel of an individual panel assembly shall be supported by two carrier assemblies consisting of steel ball bearing wheels.• Plenum closure is required for maximum sound control of the partition and must permit lifting out of header panels to adjust track height.
10 26 00	Wall and Door Protection
10 26 13	<p>Corner Guards</p> <p>Guards should be considered in all areas subject to heavy traffic and potential impacts (e.g. areas that have catering/food service function, high traffic</p>

DIVISION 10 - SPECIALTIES

**Section
Number**

Title

areas), and designed in such a manner that does not give the aesthetic appearance of a "tack on" or a design oversight.

- Surface Mounted, clear polyester or metal; minimum 2-1/2 inch X 2-1/2 inch X 48 inch
- Apply to exposed-to-view 90 degree outside corners of walls and columns
- Finish may be compatible with adjacent finishes, but must be durable and highly resistant to scratches, nicks, gouges, etc.

10 28 00

Toilet, Bath, and Laundry Accessories

10 28 13

Toilet Accessories

Commercial Accessories are required in all public restrooms.

1. Paper towel Dispensers: Georgia Pacific Translucent Smoke Push Paddle Roll Paper Towel Dispenser #54338. These are Owner furnished and Contractor installed.
2. Toilet Tissue Dispenser: WAXIE 6" Twin Toilet Tissue Dispenser #851312. These are Owner furnished and Contractor installed.
3. Soap Dispensers: 1 dispenser per 2 sinks. WAXIE Foam Soap dispenser #385830, black. These are Owner furnished and Contractor Installed.
4. Trash receptacles: Built-in independent of paper towel unit. Style and type to be reviewed and approved by Owner.
5. Disposable toilet seat covers and dispensers shall not be installed.
6. Sanitary napkin receptacles: Wall mounted, Stainless steel, one unit per each ladies' stall or 1 unit common to 2 stalls.
7. Sanitary napkin supplies should not be installed.
8. Coat hooks: one per toilet compartment with rubber end shock absorber
9. Grab bars; at accessible compartments, 1½ inch diameter, knurled stainless steel finish.
10. Mirrors:
 - One mirror per lavatory, wall mounted, 18"x 24"; one full length mirror per restroom
 - Each conforming to FS DD-G-451, Type I, Class 1, Quality q2, 1/4-inch thick, with silver coating, copper protective coating, and nonmetallic paint coating.
 - All mirrors must have a moisture sealant applied to all edges.

ADA accessible accessories shall be provided, as required by latest edition of ADAAG and the IBC.

10 28 16

Bath Accessories

Commercial Accessories are required in all public restrooms.

1. Provide stainless steel grab bars with preened surfaces and flanges for exposed mounting at accessible toilets

DIVISION 10 - SPECIALTIES

**Section
Number**

Title

- a. Grab bars and the installation of grab bars shall comply with applicable accessibility codes.
- b. Provide vandal resistant fasteners and back in partition or wall for sufficient anchoring to resist a 250 pound force applied from any direction

DIVISION 10 - SPECIALTIES

Section Number	Title
10 30 00	FIREPLACES AND STOVES
10 31 00	Manufactured Fireplaces Any time fireplaces are specified, the building's existing mechanical system's air balance status shall be verified and written definition of design impacts shall be included in the specifications.

DIVISION 10 - SPECIALTIES

Section Number	Title
10 40 00	SAFETY SPECIALTIES
10 44 00	Fire Protection Specialties
10 44 13	Fire Protection Cabinets
	<u>Part 1 – General</u>
	<ul style="list-style-type: none">• Cabinets shall be the recessed type and ADA approved. Non-locking type.• All fire extinguishers must be UL approved and bear an individual identification on the fire extinguisher.• The cylinder head and internal parts must be constructed of steel or aluminum. Stainless steel cylinders or any other cylinders requiring normal hydrostatic testing less than every twelve years are not acceptable.• The manufacturer of the fire extinguisher must be a manufacturer that meets all requirements in this section and can be serviced with the equipment, adapters, and parts that Owner currently uses and maintains (inventory and service).
	<u>Part 2 – Products</u>
	N/A
	<u>Part 3 - Execution</u>
	<ul style="list-style-type: none">• All extinguisher installations must include approved listed mounting hardware. All labs or any other area that may be considered high hazard require a fire extinguisher cabinet (s) with an extinguisher(s) meeting the minimum rating of 2-A:20-B:C. The extinguishing agent must be ammonium phosphate. Areas with flammable metal hazards require a class "D" fire extinguisher. Travel distance to a fire extinguisher in these areas is not to exceed 50 feet. Carbon dioxide or halon agents are not acceptable.• Mechanical rooms, electrical rooms and commercial kitchens need a fire extinguisher cabinet(s) with an extinguisher(s) meeting the minimum rating of 20-B:C rating. The extinguishing agent must be of sodium bicarbonate base or of a potassium bicarbonate base. Carbon dioxide or halon agents are not acceptable. Travel distance to a fire extinguisher cannot exceed 50 feet. Fire extinguishers outside the room/area of protection cannot be included in the travel distance requirements.• Corridors and all other areas requiring fire extinguishers that are not categorized in areas mentioned above or are considered light hazard to ordinary hazard areas require a fire extinguisher cabinet and an extinguisher with a minimum rating of 4-A:20-B:C. Extinguishing agent must be ammonium phosphate. Travel distance to a fire extinguisher must not exceed 75 feet.

DIVISION 10 - SPECIALTIES

Section Number	Title
10 50 00	STORAGE SPECIALTIES
10 51 00	Lockers
10 51 13	Metal Lockers
	<u>Part 1 – General</u>
	Submit fully detailed Shop Drawings and manufacturer's product data of metal lockers, including layout of lockers, color chips, and installation details.
	Type and Manufacture:
	Lockers shall be Standard Single Tier or Double Tier and Accessible Single Tier or Double Lockers of width, depth, and height as indicated. Lockers shall be furnished with sloping tops, raised bases, fillers as needed, panel ends, anchors, fasteners, and accessories as required for a complete and finished installation. Lockers shall be manufactured to meet or exceed the following requirements:
	<ul style="list-style-type: none">• Locker Units: Size and configuration as specified.• Bodies: Minimum 24 gage sheet steel, formed and flanged with stiffener ribs; electrically spot welded. Bolt spacing shall not exceed 9 inches on center.• Door Frame: Minimum 16 gage sheet steel, formed channel shape, welded and ground flush, welded to locker body.• Doors: Minimum 18 gage sheet steel, formed channel shape at vertical edges, flanged at top and bottom, with louvers at top and bottom of door face.• Locker Top, Closure Panels, and Trim: Provide end panels and filler panels to close off all openings. Provide continuous sloping top. Top, panels, and trim shall be minimum 20 gage sheet steel. Finish edges smooth without burrs.
	Hardware:
	<ul style="list-style-type: none">• Door Handle: Door handle and latching mechanism shall be the manufacturer's accessible lever handle with integral feature for locking the door with a padlock, manufactured from a chrome-plated non-corrosive alloy.• Hinges: Provide two hinges for doors under 42 inches in height and three hinges for doors over 42 inches in height. Weld hinges securely to locker frame and rivet securely to the door
	Finish:
	<ul style="list-style-type: none">• Lockers, all exposed parts exterior and interior, panels, and enclosures, shall be bonderized or phosphatized to assure maximum paint adherence, primed with a corrosion inhibitive metal primer, and finished with manufacturer's baked enamel in color from manufacturer's standards.
	<u>Part 2 – Products</u>
	N/A

DIVISION 10 - SPECIALTIES

Section Number	Title
	<u>Part 3 - Execution</u>
	Installation: <ul style="list-style-type: none">• Anchor lockers with appropriate anchor devices to suit materials encountered. Bolt adjoining locker units together to provide rigid installation. Install sloping top, end panels, and filler panels to completely close off openings.• Lockers shall be secured to the wall to resist lateral forces from a seismic event. Fastenings shall be designed by the Contractor to resist calculated loads of full lockers.• Lockers shall be installed as indicated and in accordance with the approved Shop Drawings and the manufacturer's installation instructions and recommendations.
10 56 00	Storage Assemblies
10 56 16	Fabricated Wood Storage Shelving Plywood shelving is preferred over particle board or solid wood. Minimum 3/4" thick with edge facing.
10 57 00	Wardrobe and Closet Specialties
10 57 23.16	Plastic-Laminate-Clad Closet and Utility Shelving Standard plastic laminate-faced doors are acceptable. European hinges are preferred.

DIVISION 10 - SPECIALTIES

Section Number	Title
10 70 00	EXTERIOR SPECIALTIES
10 73 00	Protective Covers Protective covers are required for exterior compressor units.
10 73 26	Walkway Coverings Covers installed in any traffic area for subsurface utilities shall be securable with a positive latching mechanism.
10 75 00	Flagpoles Inclusion of flagpoles and their location for a project must be approved by Owner (Office of the President).

*** * * END OF SECTION * * ***

DIVISION 11 - EQUIPMENT

Section Number	Title
11 30 00	RESIDENTIAL EQUIPMENT
11 32 00	Unit Kitchens
11 50 00	EDUCATIONAL AND SCIENTIFIC EQUIPMENT
11 52 00	Audio-Visual Equipment
11 80 00	FACILITY MAINTENANCE AND OPERATION EQUIPMENT
11 81 00	Facility Maintenance Equipment
11 82 00	Facility Solid Waste Handling Equipment
11 82 26	Facility Waste Compactors

DIVISION 11 - EQUIPMENT

Section Number	Title
11 30 00	RESIDENTIAL EQUIPMENT
11 32 00	Unit Kitchens Dining Hall Requirements

Part 1 - General

Plumbing:

- Minimum drain size shall be 2". Indirect waste shall be provided when required by International Plumbing Code (IPC) and/or Coconino County Health department.
- Floor drains rather than floor sinks shall be installed except when indirect waste is required by code.
- Eight inch (8") water column gas pressure (minimum) shall be provided to all fixture locations

Mechanical:

- Type 1 hoods, canopies and duct work, when provided, must conform to all applicable standards.
- Mechanical air curtains shall be installed over all exterior doorways. (Per NSF standards & Coconino County Health Department Requirements).
- No refrigeration units using R-12 will be accepted.
- Proper ambient protection controls shall be provided on all refrigeration condensing units installed outdoors.
- Refrigeration lines shall be sized and installed in accordance with American Society of Heating, Refrigerating and Air-Conditioning Engineers (ASHRAE) standards.
- Air balance and test reports shall be provided on all mechanical systems.

Electrical:

- Electrical cut-out boxes shall be of type 4 or 4X and shall be held away from any wall a minimum of 1/4"

Fire Life Safety Systems:

- Automatic fuel and power shutoffs shall be installed to all appliances under a fire protection system.
- A diagram of the fire protection system and its interface with other systems shall be provided.

Part 2 – Products

N/A

Part 3 – Execution

N/A

DIVISION 11 - EQUIPMENT

Section Number	Title
11 50 00	EDUCATIONAL AND SCIENTIFIC EQUIPMENT
11 52 00	Audio-Visual Equipment Refer to NAU Design Guidelines, Classroom and Office Design Guidelines

DIVISION 11 - EQUIPMENT

Section Number	Title
11 80 00	FACILITY MAINTENANCE AND OPERATION EQUIPMENT
11 81 00	Facility Maintenance Equipment

Part 1 – General

Following is a list of the typical housekeeping equipment to be ordered for custodial services on new construction projects. This list is provided to ensure there is adequate space and storage in the custodial closets. The final list for each project is to be reviewed and approved by Owner (Project Manager and Custodial Supervisor).

Part 2 – Products

Owner will procure these items:

- ADVANCE SC500 X20D 20" Walk Behind Scrubber W/130AH Wet Batteries.
- Windsor Titan Tip 'n Pour Wet/dry Vac 20gl w/hose & tool kit. Features powerful 1.5 hp vacuum motor and rugged construction to provide years of dependable operation. The Windsor Titan 20 gallon offers the added convenience of an optional squeegee attachment for faster large area wet pick-up. Every Titan wet/dry vacuum comes standard with an eight-piece tool kit to increase cleaning versatility.
- Rubbermaid Executive 32-gallon Brute Container, black
- Rubbermaid Executive Brute Caddy Bag, black
- Rubbermaid Executive Brute Dolly with quiet casters
- Viper Venom 20" 175 RPM 1.5 HP Floor Machine including pad driver
- Unger Speed Clean™ Window Kit. Drip-free indoor window cleaning. Quick and easy for hard to reach areas. No water spills or drips on window sills, frames, carpets and furniture. Clean in one simple step (no squeegee required), windows dry streak-free.
- 6112-77 RM Caution Wet Floor Sign, 25"
- WAXIE Versa High Performance Cleaning Caddy
- Deluxe Carpet Extraction Dual Jet Wand
- Rubbermaid Executive Janitor Cleaning Cart w/Locking Cabinet & Trash Cover.
- Rubbermaid Executive Collection 34 gallon Vinyl Cart Bag, Black.
- AQUACLEAN 18FLX CARPET EXTRACTOR
- VERSAMATIC 18IN
- ICAPSOL MINI DELUXE
- PROBLITZ XP AIR MOVER

Part 3 – Execution

N/A

DIVISION 11 - EQUIPMENT

Section Number	Title
11 82 00	Facility Solid Waste Handling Equipment

Trash chutes shall not be designed into any structures. It is required that all trash handling and pick-up be designed in exterior locations.

11 82 26	Facility Waste Compactors
----------	---------------------------

Compactors shall only be specified for food service facilities. All other locations shall be designed for exterior dumpsters.

*** * * END OF SECTION * * ***

Section Number	Title
12 20 00	WINDOW TREATMENTS
12 21 00	Window Blinds
12 24 00	Window Shades
12 24 13	Roller Window Shades
12 50 00	FURNITURE
12 51 00	Office Furniture
12 51 16	Case Goods
12 51 19	Filing Cabinets
12 51 16.16	Wood Case Goods
12 51 16.19	Plastic Laminate Case Goods
12 51 23	Office Tables
12 52 00	Seating
12 56 00	Institutional Furniture
12 56 33	Classroom Furniture
12 56 39	Lecterns
12 56 52	Audio-Visual Furniture
12 59 00	Systems Furniture
12 59 16	Free-standing component Systems Furniture
12 59 13	Panel-Hung component Systems Furniture
12 60 00	MULTIPLE SEATING
12 61 00	Fixed Audience Seating
12 90 00	OTHER FURNISHINGS
12 93 00	Interior Public Space Furnishings
12 93 23	Trash and Litter Receptors

Section Title
Number

12 20 00 WINDOW TREATMENTS

Part 1 - General

If easily accessible, window coverings can be manually operable; otherwise, coverings must be motorized with controls located at the instructor’s workstation on the AV touch panel. Where applicable, the depth of the window shall be designed to allow for the installation of motorized shade tracks.

Vertical blinds and drapes are not desired. If necessary, they are to have non-plastic, heavy-duty operating components.

All window treatments are required to have a non-reflective matte finish and unless otherwise specified, the color selection shall match or blend with the window frame.

Part 2 – Products

N/A

Part 3 - Execution

N/A

12 21 00 Window Blinds

Part 1 - General

Horizontal blinds are permitted, pending submittal review and approval by Owner.

Part 2 – Products

N/A

Part 3 - Execution

N/A

12 24 00 Window Shades

12 24 13 Roller Window Shades

Part 1 - General

Use of a light diffusing and room darkening (where applicable) roller shades are preferred. DP shall calculate percentages of light diffusion for each window by evaluating the individual window’s orientation and the intensity of the exposure.

Part 2 – Products

N/A

Part 3 - Execution

N/A

Section Title
Number

12 50 00 FURNITURE

Part 1 - General

Furniture selection is dictated by NAU standards for classrooms and office spaces in the Design Guidelines. Owner will procure furniture, unless otherwise identified. All final furniture selections will be reviewed and approved by Owner prior to order placement. All furniture drawings shall be reviewed for code compliance prior to final specification. For additional information refer to the Design Guidelines.

Owner will assist the Design Professional with the selection of products based on their requirements. Drawings, furniture plans and electrical plans, and furniture specifications are to be provided to Owner for review and final approval. The furniture specifications are to be provided with the information per item listed here.

Item No./Callout	indicated on spec sheet and furniture plans
Manufacturer	indicate style/series, Manufacturer Number, Dimensions and Description; provide photo of item
Fabric	indicate manufacturer, pattern, color, width, repeat, application, and use of multiple fabric; provide photo image of fabric
Finishes	indicate color and application: provide photo image of finish
Notes	as needed for further information to order the furniture accurately
Room # & Location	
Quantity	

Part 2 – Products

N/A

Part 3 - Execution

N/A

12 51 00 Office Furniture

12 51 16 Case Goods

Part 1 - General

N/A

Part 2 – Products

Open Office Furniture

Integrated options to be available in selected system

- a. Height Adjustment – Adjustable worksurfaces from 24 ½” to 52” height
- b. Edge Detail – 3MM plastic edge, bullnose or sloped edge; no laminate self edge
- c. Cable Routing – Cable management system integral to the product
- d. Privacy – Privacy screens and modesty panels required

Section Title
Number

- e. Worksurfaces – Rectangular and curvilinear required
- f. Storage – Pedestal storage to include box and file drawers with mobile option
- g. Storage – Vertical Cabinets stand-alone & over desk storage open or closed (desk mounted)
- h. Worksurface – Laminate covered particle board or steel core
- i. Cord Cutouts or Grommets shall be available on all worksurfaces
- j. Levelers – Leveling glides required on all support legs with minimum ½” adjustment
- k. Size – Minimum requirement depth desk unit 24” to 36”
- l. Size – Minimum requirement width desk 30” to 72”

Part 3 - Execution

N/A

12 51 16.16 Wood Case Goods

Part 1 - General

N/A

Part 2 – Products

Integrated options to be available in selected casegood

- a. Desk
- a. Return
- b. Credenza
- c. Bridge
- d. Bullet table
- e. Lateral file
- f. Bookcase
- g. Service module

Specifications

- a. Full height back panel and pedestals
- b. Wood drawer interior
- c. One hanging file folder frame per drawer
- d. Leveling glides
- e. Pencil tray

Part 3 - Execution

N/A

12 51 16.19 Plastic Laminate Case Goods

Part 1 - General

N/A

Part 2 – Products

Integrated options to be available in selected casegood

- a. Desk
- b. Return
- c. Credenza

Section Title
Number

- d. Bridge
- e. Bullet table
- f. Lateral file
- g. Bookcase
- h. Service module

Specifications

- f. Full height back panel and pedestals
- g. Wood drawer interior
- h. One hanging file folder frame per drawer
- i. Leveling glides
- j. Penciy tray

Part 3 - Execution

N/A

12 51 19

Filing Cabinets

Part 1 - General

N/A

Part 2 – Products

Integrated options to be available in selected storage

LATERAL FILES

- a. Steel construction
- b. Available Front to back or side to side drawer configuration
- c. Locking
- d. Available Multiple widths (30",36" & 42")
- e. Available in multiple heights (26 1/4" to 62 3/4")(minimum)
- f. Leveling glides
- g. Laminate top option
- h. Safety interlock to open one (1) drawer at a time
- i. Counter weights (required)

BOOKCASES

- a. Steel construction
- b. Available Multiple widths (30",36" & 42")
- c. Available in multiple heights (26" to 65")(minimum)
- d. Adjustable shelves
- e. Laminate top option

STORAGE CABINETS

- a. Steel construction
- b. Adjustable shelves
- c. Locking
- d. Available in multiple heights 26" to 65" minimum
- e. Available in Multiple widths
- f. Available in 18" depth (minimum)

Part 3 - Execution

Section Number	Title
	N/A
12 51 23	<p>Office Tables</p> <p><u>Part 1 - General</u></p> <p>N/A</p> <p><u>Part 2 – Products</u></p> <p>Integrated options to be available in selected table style</p> <ol style="list-style-type: none"> a. Round Top diameters (30” to 60”)(minimum) b. Square Top dimensions (30”X30”) to (48”X48”) (minimum) c. Rectangular Top dimensions (24”X48”) to (30”X72”)(minimum) d. Laminate Top e. Leveling Glides f. Chrome Base Option g. Caster option for smaller tables <p><u>Part 3 - Execution</u></p> <p>N/A</p>
12 52 00	<p>Seating</p> <p><u>Part 1 - General</u></p> <p>N/A</p> <p><u>Part 2 – Products</u></p> <p>High Performance Ergonomic Task Seating</p> <p>Integrated options to be available in selected chair style</p> <ol style="list-style-type: none"> a. Adjustable seat angle b. Adjustable back angle, tilt and vertical adjustment c. Adjustable seat depth and tilt d. Adjustable back height e. Pneumatic height adjustment f. Swivel tilt g. Height, width and pivot adjustable arms h. Armless i. Soft arm caps j. Fully upholstered back panel k. Available with high and mid back l. Available in Plus and Small size frames m. Five arm base w/dual wheel casters n. Soft and hard wheel casters <p>Side Seating</p> <p>Integrated options to be available in selected chair style</p> <ol style="list-style-type: none"> a. Sled base b. Leg base with hard and soft caster option c. Plastic or poly seat and back

Section Title
Number

- d. Upholstered seat and back
- e. Plastic arm caps
- f. Frame colors available
- g. Chrome frame available
- h. Standard back height

Conference seating

Integrated options to be available in selected chair style

- a. Five arm base with casters
- b. Leg base with caster option
- c. Fixed arms
- d. Pneumatic height adjustment
- e. Tilt lock
- f. Soft arm caps

Part 3 - Execution

N/A

12 56 00 Institutional Furniture
12 56 33 Classroom Furniture
Refer to Design Guidelines.

12 56 39 Lecterns
Instructor Station
Refer to Design Guidelines.

12 56 52 Audio-Visual Furniture
Refer to Design Guidelines.

12 59 00 Systems Furniture
12 59 13 Panel-Hung component Systems Furniture

Part 1 - General

Integrated options to be available in selected system

- a. Compliance with ANSI/BIFMA X5.6-2003 for all panels, components, wiring & lighting.
- b. The Entire System shall be U.L. approved.
- c. The complete system shall be of one (1) product manufacturer.
- d. Panel Types
 - i. fabric covered acoustical panel
 - ii. glazed panel
 - iii. door panel
 - iv. pass through panel
 - v. tackable acoustical panel

Section Number	Title
	<p>e. Panel Size – fabric covered shall be available in six panel heights ranging from 30” to 80” and at least six (6) panel widths ranging from 18” to 60”. Panels shall be a minimum of 2 ¼” thick.</p> <p>f. Configuration of Panels – Panels shall be fully interchangeable between various sizes and heights and shall be capable of being arranged in a variety of configurations having two, three and four panels radiating from a single source</p> <p>g. Attachment to Walls – Panels shall have provisions for attachment to permanent walls when required.</p> <p>h. Panels shall have 1” incremental hanging capability for worksurfaces, bins and shelves inherent in the panel frame for the full height of the panel.</p> <p>i. Cover Material – Fabric covered panels shall be covered on front and back. The fabric shall be of a woven texture; colors shall be available in muted tones (preferably grays, beige etc.)</p> <p>j. Installation/Reconfiguration – Panel systems shall be capable of being moved and reinstalled easily without the use of highly specialized tools.</p> <p>k. Cleaning – All surfaces of the system shall resist stain and be easily cleaned</p> <p>l. Modification – The system shall be capable of adding electrification components in the field at some future time with a minimum of panel modification.</p> <p>m. Finish Detail – The system shall be void of sharp-edged components</p> <p>n. Core Construction – Core construction shall allow panel to be rigid and capable of supporting loaded components. Core construction shall not allow for flexing or torquing of panel. Panel system strength should be strong without the use of floor supported products (peds, end panels, lateral files, etc.). Counterbalance of system components should not be required.</p> <p>o. Sound Resistance – Acoustical panels shall have a minimum of .80 NCR sound classification as tested in accordance with ASTM, C-423-90a and a minimum STC of 20 as tested in accordance with ASTM, e-413-87 (1994) shall be available within the product line. Tackable acoustical panels shall have a minimum of .65NRC sound classification as tested in accordance with the above standards.</p> <p>p. Fire Resistance – All panels shall have Class A fire rating as tested in accordance with ASTM, E84-96a.</p> <p>q. Connectors – Panel connectors shall be re-usable where necessary to connect adjacent panels to form the panel structure. Panel connectors shall be made of strong materials. The system shall have simple rigid connections.</p> <p>r. Edges & Fillers – All panel edges not joined to another panel shall be provided with a finished end cap. Corner fillers shall be used at all junctions between panels.</p> <p>s. Trim – All vertical trim shall be of metal frame and painted. Vertical side frames shall have concealed painted inserts slotted up to 1 ½” centers to maximize vertical utilization of components. The panel top shall be trimmed with a vinyl; steel, wood or fabric-covered extrusion cap and shall match the system color scheme.</p> <p>t. Levelers – A minimum of two (2) panel supported levelers shall be used to provide a rigid panel system and shall have the capability top level panels on an uneven floor. Levelers shall support the weight of the system. Levelers shall have a minimum vertical adjustment of ½”.</p> <p>u. Raceways – Raceways shall be at the top and the bottom of panels. Raceways shall be either integral or capable of being integrated into panels. Cabling within the</p>

Section Title
Number

raceway shall be concealed at all junctions between panels. Raceways shall make provisions for distribution of electrical wiring to run adjacent to data and telephone cabling. Electrical wiring shall be mechanically isolated if not shielded or in conduit.

- v. Electrical Requirements – The minimum electrical requirement shall be for a 4-circuit 8-wire system. Panels with raceways that are 24” or wider, shall have a minimum of two (2) receptacles per side and have space available for an additional port for installation of data and telephone receptacles. Electrical systems offered shall be 102v, 20 amp circuits capable of transitioning through multiple panel intersections. All receptacles whether simplex or duplex, shall support a minimum of 15 amps electrical load.
- w. Power Poles – Power poles shall be available and shall be capable of attaching to the top or the end of a panel. Or to a connecting junction and integrating with the panel electrical system.
- x. Required Components
 - i. Task Lighting - LED type, U.L listed and conforms to the National Electric Code
 - ii. Work Surfaces – Shall be either steel or particle board covered with laminate. Particle board to have backer sheet underside. Minimum thickness to be 1 ¼” thick. All exposed edges shall be finished to match the worksurface or have a vinyl edge band
 - iii. Work surfaces to be cantilever or floor supported
 - iv. Cord Cutouts or Grommets shall be available on all worksurfaces
 - v. Storage – Drawers required to include file drawers, box drawers, pencil drawers, pedestals, and flipper door storage cabinets.
 - vi. Security – All storage with the exception of the pencil drawer shall have the capability of being locked.

Part 2 – Products

N/A

Part 3 - Execution

N/A

12 59 16 Free-standing component Systems Furniture

Part 1 - General

Integrated options to be available in selected system

- a. Height Adjustment – Adjustable worksurfaces from 24 ½” to 52” height
- b. Edge Detail – Bullnose, sloped edge, 3mm edge
- c. Cable Routing – Cable management system integral to the product
- d. Privacy – Privacy screens and modesty panels required
- e. Worksurfaces – Rectangular and curvilinear required
- f. Storage – Pedestal storage to include box and file drawers with mobile option
- g. Storage – Lateral File, counterweights must be included
- h. Storage – Vertical Cabinets stand alone & over desk storage open or closed (desk mounted)

Section Title
Number

- i. Worksurface – Laminate covered particle board or steel core
- j. Counter Tops – Transaction Worksurfaces
- k. Spanner Tables – Worksurfaces to connect workstations
- l. Jetty Tables/Peninsula Tables
- m. Cord Cutouts or Grommets shall be available on all worksurfaces
- n. Levelers – Leveling glides required on all support legs with minimum ½” adjustment
- o. Column mounted Shelves and Screens
- p. Multiple screen heights for privacy
- q. Multiple worksurface offerings for corner and straight units.
- r. Desk Size – Minimum requirement depth desk unit 24” to 30”
- s. Desk Size – Minimum requirement width desk 24” to 78”
- t. Corner Unit Size
- u. Storage Towers
- y. Required Components
 - i. Task Lighting - LED type, U.L listed and conforms to the National Electric Code
 - ii. Work Surfaces – Shall be either steel or particle board covered with laminate. Particle board to have backer sheet underside. Minimum thickness to be 1 ¼” thick. All exposed edges shall be finished to match the work surface or have a vinyl edge band
 - iii. Work surfaces to be cantilever or floor supported
 - iv. Cord Cutouts or Grommets shall be available on all work surfaces
 - v. Storage – Drawers required to include file drawers, box drawers, pencil drawers, pedestals, and flipper door storage cabinets.
 - vi. Security – All storage with the exception of the pencil drawer shall have the capability of being locked

Part 2 – Products

N/A

Part 3 - Execution

N/A

Section Title
Number

12 60 00 MULTIPLE SEATING

12 61 00 Fixed Audience Seating
Refer to Design Guidelines.

Contractor shall submit shop drawings for review and approval by Owner.

Section Title
Number

12 90 00 OTHER FURNISHINGS

12 93 00 Interior Public Space Furnishings

12 93 23 Trash and Litter Receptors

Lobby Unit Recycling and Trash Standards

These standards are intended to create a unified and consistent recycling and landfill waste system on campus. **All final designs must be approved by Owner (Office of Sustainability).**

Colors:

- Blue for recycling and Brown for waste.
- Lettering and symbols should be white.
- All panels of the bin should be appropriately colored.

Wording: “Landfill” for waste and “Recycling” for recyclables.

Symbols:

- The white universal recycling symbol is to be used for recycling and the white “waste person” symbol is to be used for “Landfill”.
- There will be a symbol on the top, front and both sides of the bin, excluding the back.

Shape of Unit:

- Unit is to be rectangular in shape and “Landfill” and “Recycling” sections should be connected so that the unit is one dual unit.
- Left side is “Landfill” and right is “Recycling.”
- The unit will be front loading with rectangular openings.
- Unit HxWxD should not exceed 46”x43”x21”.

Liners, Capacity, & Other:

- Each side will have approximately 32 gallons of capacity.
- Liners will accommodate a 38x58 flat cut bag.
- Front of unit will open on each side to give access for servicing.
- Units must be constructed with a majority of post-consumer recycled content.

As an example, previous manufacturers that have been used were Clean River and Max-R. **All final designs must be approved by Owner (Office of Sustainability).** This is an Owner furnished item.

Section Title
Number



Small and Medium Bins

For other areas that do not require the capacity of a lobby unit small and medium recycling and waste bins should be used. As for the lobby units recycling will be blue with a white recycling symbol and waste will be brown with the white “waste person” symbol. This is an Owner furnished item. All final designs must be approved by the Owner (Office of Sustainability).

Examples of bins that meet these requirements are:

Medium Recycling: Tough Guy Recycling Container, 23 gal, Blue Manufacturer Number 4UAU7

Medium Waste: Tough Guy Open-Top Trash Can, Rectangular, 23 gal Manufacturer Number 10F624

Small Recycling: Rubbermaid Recycling Container, 7 gal, Blue, Manufacturer Number FG295673

Small Waste: Continental rectangular wastebasket, 7 gal, Brown Manufacturer Number 2818BN

Section Title
Number



Mini Bins

In offices there will only be a recycling bin and a mini bin. Only the recycling bin will be serviced by Owner’s custodial staff. A “mini bin” is given to office occupants so that clearing their own waste to a common area waste bin will be more convenient. The mini-bin size should be 1.5 L or 0.4 gallons. This is an Owner furnished item. All final designs must be approved by the Office of Sustainability.



****END OF SECTION****

DIVISION 13 - SPECIAL CONSTRUCTION

Section Number	Title
13 20 00	SPECIAL PURPOSE ROOMS

DIVISION 13 - SPECIAL CONSTRUCTION

Section
Number

13 20 00

Title

SPECIAL PURPOSE ROOMS

Copy Rooms

A minimum area of 5' x 6' for small copy machines and 6' x 9' in length for large copy machines shall be reserved in office area designs. This space shall be equipped with a dedicated circuit and shelving and/or lockable cabinets.

The copy room area shall be "hidden" from daily traffic yet central to the entire user population.

Recycling Areas

Include the following space requirements as a minimum:

TYPE OF MATERIAL

MINIMUM SPACE REQUIRED

Paper generated by copy machines or in work stations	22" deep x 24" wide
Newspaper generated in common areas	22" deep x 24" wide

Aluminum collection - near vending machines or in kitchen 22" deep x 12" wide

Individual Offices: White and colored paper only	22" deep x 18" wide
White, colored paper and newspaper	22" deep x 24" wide

Custodial Closets

There shall be one custodial closet per building floor level, minimum. Spaces shall be designed according to the following:

- Custodial closets shall contain a minimum working space of 92 square feet and shall be equipped with a 3'0" minimum door.

Closets shall be equipped with:

- A corner located, floor mounted mop sink (with an 8" curb)
- Reinforced hot/cold tap with institutional grade hardware
- Wall mounted mop racks and a minimum of twelve lineal feet of 11" deep fixed shelving. Shelving to be mounted at five-foot height to allow for machine storage underneath.

A minimum 5'0" x 2'0" clear floor space shall be maintained to accommodate a vacuum unit. Larger spaces may be necessary at times based on building requirements.

A floor drain, with the entire floor sloped a minimum ¼" per foot, to the floor drain is required.

DIVISION 13 - SPECIAL CONSTRUCTION

Section
Number

Title

Input from the Owner (Custodial Department) is mandatory during project programming phase.

There shall be a minimum of 3 GFI duplex electrical outlets.

Water heaters, electrical panel boxes, pipe chases, entrance doors to adjoining rooms, etc. shall not be included in custodial closet space.

Closet floors shall be color sealed concrete, or painted with an epoxy paint.

Extra Stock Storage Rooms

DP shall review the closeout requirements for extra stock product and determine the amount of storage space required to accommodate these materials. It is preferred that the room be located on the ground floor and in a secured room.

Dining Rooms

Refer to 11 32 00 for information on Unit Kitchens.

DIVISION 14 – CONVEYING EQUIPMENT

Section Number	Title
14 20 00	ELEVATORS
14 21 00	Electric Traction Elevators
14 24 00	Hydraulic Elevators
14 24 13	Hydraulic Freight Elevators
14 24 23	Hydraulic Passenger Elevators (Machine Room Less [MRL])
14 24 43	Hydraulic Service Elevators

Section Number	Title
14 20 00	ELEVATORS

Part 1 - General

The size, number, and location of elevators must be addressed at the earliest stages of the design, to ensure that neither the overall function of the facility nor the optimum configuration of elevators is compromised. The size and location of the machine room is similarly critical.

Provide a minimum elevator machine room size of 100 square feet, exclusive of the area above the hoistway (for traction elevators), and without any odd corners, narrow passages or structural interferences.

Design Professional shall design elevators to comply with current ASME A117.1, ASME A117.2, IBC, NEC codes referenced in Division 1.

When new elevators are being installed into existing buildings where elevators do not currently exist (as opposed to elevator modernization) comply with the criteria for new elevators..

The Design Professional is expressly responsible for incorporating these overall requirements into the project, and for ensuring that all sub-consultants are aware of the requirements and incorporate them into their designs as well.

Reliance on "after-the-fact" equipment selections to compensate for a problematic design decision is unacceptable.

Service elevators shall be located near the loading dock.

Basic Elevator Selection

Hydraulic elevators are generally used in low-rise buildings with two to three floors. Electric traction elevators are generally used in buildings over three stories. Design Professional shall coordinate the electrical requirements as well as the code requirements for the pit, overhead clearance, shaft ventilation, pit ladder, light (with switch adjacent to ladder) and electrical duplex 120 VAC outlet in pit, equipment room and phone in cab.

GENERAL REQUIERMENTS FOR ALL ELEVATORS:

- In all multi-level buildings and facilities, at least one passenger elevator shall serve each level, including mezzanines. (If more than one elevator is provided, each full passenger elevator shall comply with this section). Standby power shall be provided in accordance with code referenced in Division 1.
- Elevators shall have button controls to each floor without keying to shut down the unit and, if required by the program, to lock out selected floors.
- Specifications shall include attention to interlock to existing or proposed fire detection systems and devices.
- All elevator operating switches shall be keyed alike according to function.

Section Title
Number

- Elevators shall be located as close as practical to stairways to facilitate use of stairways for those with that preference.
- Where elevator rise is 60 feet or more, a two-way communications means within the building and accessible to emergency personnel to speak with persons in each elevator car individually shall be provided. Operating instructions shall be incorporated with or adjacent to the two-way communication means outside the elevator car.
- Buildings four or more stories above or below grade plane shall be provided with an elevator capable of transporting 24" by 84" open ambulance stretcher and be identified on the hoist way door frame for such use.
- In buildings or structures where standby power is required (i.e.; 75 feet of rise or more) or provided for elevators(s), all electrical circuits required for elevators(s) shall be connected to the standby power source.

Hoist Ways:

- Where applicable, hoistway glass shall be laminated and each piece visibly marked as per ANSI Z97.1 or 16 CFR Part 1201. Windows prohibited in hoistways.
- Hoistway ventilation to the outer air shall be provided, per the building code, for elevators penetrating more than three floors. The area of the hoistway vent shall not be less than 3 ½ percent of the area of the hoistway nor less than 3 square feet for each elevator car.
- Projections, ledges, or recesses more than 4 inches shall be beveled not less than 75 degrees.
- Where applicable, hoistway access doors of secondary and overhead machinery spaces shall be a minimum of 29 ½ inches in width and height and shall be self-closing and self-locking using a spring-type lock.
- Where applicable, hoistway access doors necessary for access to an MRL elevator emergency brake shall be a maximum of 24 inches in width and height and shall be self-closing and self-locking using a spring-type lock. Keys to unlock the access doors shall be Group 1 Security (restricted to elevator personnel only).
- Where applicable, headroom in secondary and overhead machinery spaces shall be a minimum of 42 inches without a governor and 53 inches with a governor.
- The minimum vertical distance in the refuge area between the car top and the overhead structure or other obstruction shall not be less than 43 in. when the car has reached maximum upward travel.
- Where applicable, hoistway machinery spaces shall be provided with a minimum of 19 foot candle lighting with light guard. The light switch shall be located within easy reach of access to such phase.

Section Title
Number

- Where applicable, hoistway machinery spaces shall be provided with means, mechanical if necessary, to keep the temperature and humidity in the range specified by the elevator equipment manufacturer.
- Machinery and equipment or electrical equipment and wiring that does not pertain to the elevator is prohibited.
- Pipes or ducts conveying gases, vapors, or liquids that do not pertain to the elevator are prohibited.
- Where applicable, secondary and overhead machinery spaces shall be provided with a GFCI protected duplex receptacle. Machinery space lighting and receptacle shall be on a separate branch circuit.

Pit:

- Pit floors shall be level and have a sump for a drain or sump pump, and have a sump cover that is flush with the floor. Drains or sump pumps shall remove a minimum of 50 GPM per elevator. Exposed discharge lines shall be of metal. Discharge lines shall be provided with a check valve installed close to the drain or pump. Shut-off vales in discharge lines and oil sensing equipment to stop fluid removal are not allowed.
- Access to pits shall be by a ladder extending to at least 48 inches above the lowest landing or by a separate pit access door, where required. Ladders shall be within reach from the lowest landing door.
- Pits shall be provided with a minimum of 10 foot candle lighting with light guard. The light switch shall be located on the pit ladder side and within easy reach from the pit access door.
- Provide a permanent means to access the underside of the car (i.e.; working platform) if the distance from the pit floor to the underside of the plank channels or slings exceeds 83 inches.
- Pits shall be provided with a GFCI protected duplex receptacles. A single non-GFCI receptacle shall be provided for the sump pump. Pit lighting and receptacles shall be on a separate branch circuit.

Fire Protection:

- If sprinkled, all electrical equipment in the pit within 48 inches above the pit floor shall be weather proof (NEMA 4 Rated) and wiring identified for use in wet locations per NFPA 70
- Sprinkler protection shall supply only branch lines at not more than one floor level. Sprinkler lines running up the hoistway are prohibited. Pit sprinkler heads shall be within 24 inches of the pit floor.
- When sprinklered, a main power shunt-trip disconnect and heat detector(s) is required. Heat detectors shall be within 2 feet of each sprinkler head at the top

Section Title
Number

of the hoistway and in the machine/control room or control space.. No heat detectors in sprinkler pits.

- Provide smoke detector(s) in the top of hoist ways that are sprinklered.
- Sprinkler protection shall supply only branch lines into the machine/ control room or control space.
-

Machine Room:

- Provide machine room (control room/ control space, if applicable) enclosure. Seal all gaps and penetrations.
- There shall be a minimum of 18 inches around equipment for maintenance path and clearance.
- Safe, permanent, and unobstructed access to these rooms/ spaces shall be a minimum of 60 degrees from the horizontal, have handrails, and have a platform, at the access-door sill level. Platform length shall permit full swing of the door plus 2 feet for doors that swing out and platform length for doors that swing in shall be not less than the width of the door. Ships ladders are not acceptable as stairs. Access doors to machine rooms, control rooms, and control spaces shall be self-closing and self-locking using a spring-type lock. Doors to machine and control rooms shall not be less than 29 ½” wide and 80” high.
- Machine/ control rooms shall have clear headroom of not less than 84 inches. Control spaces, where applicable, shall have clear headroom of not less than 778 inches or the height of the equipment, whichever is greater.
- Machine rooms and control rooms, where provided, shall not be located in the hoistway.
- Where applicable, remote machine rooms and/ or control rooms of electric elevators shall be provided with a permanent means of communication between the elevator car and remote machine room and/ or control room.
- Machine rooms, control rooms, and control spaces shall have a minimum of 19 foot candle lighting with light guard. Light switch shall be within reach from the door and on the lock-jamb side.
- Machine rooms, control rooms, and control spaces shall have independent ventilation means to keep the air temperature and humidity in the range specified by the elevator equipment manufacturer.
- Machinery, equipment, electrical equipment, or wiring not pertaining to the elevator is prohibited in the machine room.
- Pipes or ducts conveying gases, vapors, or liquids that do not pertain to the elevator in the machine room are prohibited.
- There shall be smoke detection in machine/ control rooms and control spaces for fire recall.

Section Title
Number

- There shall be a class “ABC” fire extinguisher in machine/ control rooms and control spaces.
- All wiring shall be installed in metal conduit, box, or wire way.
- A separate branch circuit shall supply the car lights.
- A separate branch circuit shall supply the machine/ control room /control space lighting and receptacle. There shall be a duplex GFCI receptacle in the machine/ control room or control space.
- A separate branch circuit shall supply the machine / control room or control space air conditioning equipment. A disconnect with overcurrent protection and lockable in the open position shall be provided.
- A single means of disconnect, with overcurrent protection and lockable in the open position, shall be provided for the main power supply (see #35). Per NFPA70-620.91 (c) The main power disconnect shall be provided with an auxiliary contact for use on hydraulic elevators with battery lowering.
- All disconnecting means shall be provided with identification and power feed locations.
- A car light disconnect, with overcurrent protection and lockable in the open position, shall be provided in the machine/ control room or control space (see #42).
- Plumbing systems (i.e.; floor drains) shall not be installed in the elevator machine/ control rooms or spaces.

Miscellaneous:

- Pipes (i.e.; sprinkler) or similar equipment that contains liquid shall not be located directly above elevator or electrical equipment. Pipes shall not encroach upon any required clearances.
- Air conditioning equipment and condensate drains shall not be installed directly above the elevator or electrical equipment. Condensate drain lines shall not be connected directly to sewers. There shall be safe and convenient access for servicing and maintenance of air conditioning equipment.

Part 2 – Products

N/A

Part 3 – Execution

N/A

14 21 00 Electric Traction Elevators

Part 1 – General

Section Title
Number

WORK INCLUDED

- Installation of a new traction elevator

Part 2 – Products

N/A

Part 3 – Execution

SUBMITTALS

Product data: Contractor shall provide standard cab entrance and signal fixture data to describe product for approval.

Powder Coat Paint selection: Submit manufacturer’s standard selection charts for exposed finishes and materials.

Plastic laminate selection: Submit manufacturer’s standard selection charts for exposed finishes and materials.

Metal Finishes: Upon request, standard metal samples provided.

SHOP DRAWINGS

- Show equipment arrangement in the pit and hoistway. Provide plans, elevations, sections and details of assembly, erection, anchorage, and equipment location.
- Indicate elevator system capacities, sizes, performances, safety features, finishes and other pertinent information.
- Show floors served. Travel distances, maximum loads imposed on the building structure at points of support and all similar considerations of the elevator work.
- Indicate electrical power requirements and branch circuit protection device recommendations.

OPERATION AND MAINTENANCE DATA

Include the following:

- Owner’s Manual and Wiring Diagrams.
- Parts list, with recommended parts inventory.

QUALITY ASSURANCE

Manufacturer Qualifications: An approved manufacturer with minimum fifteen years experience in manufacturing, installing, and servicing commercial elevators.

- Must be the manufacturer of the power unit, controller, signal fixtures, door operators cab, entrances, and all other major parts of the elevator operating equipment.

Section Title
Number

- The major parts of the elevator equipment shall be manufactured in the United States, and not be an assembled system.
- The manufacturer shall have a documented, on-going quality assurance program.
- ISO-9001:2000 Manufacturer Certified
- ISO-14001:2004 Environmental Management System Certified

Installer Qualifications: The manufacturer or an authorized agent of the manufacturer with not less than fifteen years of satisfactory experience installing elevators equal in character and performance to the project elevators.

USE OF ELEVATOR

- The elevator shall not be used temporarily for building construction purposes unless specifically allowed by the Owner.
- If the Contractor is allowed to use the elevator prior to Substantial Completion of the project, the warranty and service period shall not be comprised and shall begin when substantial completion is achieved.

OPERATION, EQUIPMENT AND FUNCTION

Operation And Maintenance

- Starting at the time of Substantial Completion of the complete project, provide complete systematic inspection and maintenance of the elevator for a period of 24 months. Furnish trained experts and equipment to check, adjust, lubricate, and otherwise maintain the elevator in operation without defects or deterioration. Replace or repair materials and parts which become defective or deteriorated for any reason except through abuse or misuse by Owner.
- Instruct Owner’s personnel in proper use, operations and daily maintenance of elevators.
- Training shall include operation of diagnostic microcomputer and servicing of elevator microprocessor.
- Make final check of each elevator operation, with Owner’s personnel present and just prior to date of substantial completion. Determine that control systems and operating devices are functioning properly.
- Continuing Maintenance: Provide 2-year maintenance on elevators on an as-needed basis as part of standard 2-year warranty on new equipment and upgrades.
- Maintenance shall include systematic examination, adjustment and lubrication of new elevator equipment; replacement of seals, packing and valves to maintain required factor of safety; performance of maintenance work without removing car during peak traffic periods and providing 24 hour emergency call back service during maintenance period, at an additional cost to Owner.

Section Title
Number

- Repair or replace electrical and mechanical parts of the new elevator equipment using only genuine standard parts produced by manufacturer of equipment concerned.
- Ensure that competent personnel handle maintenance service. Maintain and adequate stock of parts for replacement of emergency purposes, locally, and have qualified personnel available at such places to ensure the fulfillment of this service without unreasonable loss of time.

Cleaning

- Remove all trash and debris from site during elevator installation.
- Clean all elevator surfaces, removing all dirt, dust, spots, and scratches. Any damage shall be repaired or replaced as directed by Owner, at no cost to Owner.
- Prior to substantial completion, remove protection from finished or ornamental surfaces and clean and polish surfaces with due regard to type of material.
- Remove tools, equipment and surplus materials from site.

14 24 00

Hydraulic Elevators

Part 1 - General

WORK INCLUDED

- Installation of a new hydraulic elevator complete as described in this standard.
- Provide an engineered system in accordance with this document.
- **GENERAL NOTE:** All hydraulic elevators will need an oil separator or an underground storage tank in the event of a water discharge in the pitto ensure hydraulic fluid does not get into the sewer system.

Part 2 – Products

N/A

Part 3 - Execution

SUBMITTALS

Product data: Contractor shall provide standard cab, entrance and signal fixture data to describe product for approval.

Shop drawings:

- Show equipment arrangement in the pit and hoistway. Provide plans, elevations, sections and details of assembly, erection, anchorage, and equipment location.
- Indicate elevator system capacities, sizes, performances, safety features, finishes and other pertinent information.
- Show floors served, travel distances, maximum loads imposed on the building structure at points of support and all similar considerations of the elevator work.

Section Title
Number

- Indicate electrical power requirements and branch circuit protection device recommendations.

Powder Coat Paint selection: Submit manufacturer’s standard selection charts for exposed finishes and materials.

Plastic laminate selection: Submit manufacturer’s standard selection charts for exposed finishes and materials.

Metal Finishes: Upon request, standard metal samples provided.

Operation and maintenance data. Include the following:

- Owner’s Manual and Wiring Diagrams.
- Parts list, with recommended parts inventory.

QUALITY ASSURANCE

Manufacturer Qualifications: An approved manufacturer with minimum fifteen years’ experience in manufacturing, installing, and servicing commercial elevators.

- Must be the manufacturer of the power unit, controller, signal fixtures, door operators cab, entrances, and all other major parts of the elevator operating equipment.
- The major parts of the elevator equipment shall be manufactured in the United States, and not be an assembled system.
- The manufacturer shall have a documented, on-going quality assurance program.
- ISO-9001:2000 Manufacturer Certified
- ISO-14001:2004 Environmental Management System Certified

Installer Qualifications: The manufacturer or an authorized agent of the manufacturer with not less than fifteen years of satisfactory experience installing elevators equal in character and performance to the project elevators.

USE OF ELEVATOR

- The elevator shall not be used temporarily for building construction purposes unless specifically allowed by the Owner.
- If the Contractor is allowed to use the elevator prior to Substantial Completion of the project, the warranty and service period shall not be compromised and shall begin when substantial completion is achieved.

OPERATION AND MAINTENANCE

Section Title
Number

- Instruct Owner’s personnel in proper use, operations and daily maintenance of elevators.
- Training shall include operation of diagnostic microcomputer and servicing of elevator microprocessor.
 - Make final check of each elevator operation, with Owner’s personnel present and just prior to date of substantial completion. Determine that control systems and operating devices are functioning properly.
 - Continuing Maintenance: Provide 2-year maintenance on elevators on an as-needed basis as part of standard 2-year warranty on new equipment and upgrades.
 - Starting at the time of substantial completion of the complete project, provide complete systematic inspection and maintenance of the elevator for a period of 24 months. Furnish trained experts and equipment to check, adjust, lubricate, and otherwise maintain the elevator in operation without defects or deterioration. Replace or repair materials and parts which become defective or deteriorated for any reason except through abuse or misuse by Owner.
 - Maintenance shall include systematic examination, adjustment and lubrication of new elevator equipment; replacement of seals, packing and valves to maintain required factor of safety; performance of maintenance work without removing car during peak traffic periods and providing 24 hour emergency call back service during maintenance period, at an additional cost to Owner.
 - Repair or replace electrical and mechanical parts of the new elevator equipment using only genuine standard parts produced by manufacturer of equipment concerned.
 - Ensure that competent personnel handle maintenance service. Maintain an adequate stock of parts for replacement of emergency purposes, locally, and have qualified personnel available at such places to ensure the fulfillment of this service without unreasonable loss of time.

CLEANING

- Remove all trash and debris from site during elevator installation.
- Clean all elevator surfaces, removing all dirt, dust, spots, and scratches. Any damage shall be repaired or replaced as directed by Owner, at no cost to Owner.
- Prior to substantial completion, remove protection from finished or ornamental surfaces and clean and polish surfaces with due regard to type of material.
- Remove tools, equipment and surplus materials from site.

14 24 23 Hydraulic Passenger Elevators (Machine Room Less [MRL])

Part 1 – General

Section Title
Number

N/A

Part 2 – Products

HOISTWAY EQUIPMENT

Platform: Fabricated frame of formed or structural steel shapes, gusseted and rigidly welded with a wood subfloor. Underside of the platform shall be fireproofed. The car platform shall be designed and fabricated to support one-piece loads weighing up to 25% of the rated capacity.

Sling: Steel stiles affixed to a steel crosshead and bolstered with bracing members to remove strain from the car enclosure.

Guide Rails: Steel, omega shaped, fastened to the building structure with steel brackets.

Guide Shoes: Slide guides shall be mounted on top and bottom of the car.

Buffers: Provide substantial buffers in the elevator pit. Mount buffers on a steel template that is fastened to the pit floor. Provide extensions if required by project conditions.

Jack: Jack unit shall be of sufficient size to lift the gross load the height specified. Factory test jack to insure adequate strength and freedom from leakage. Brittle material, such as gray cast iron, is prohibited in the jack construction. Provide the following jack type: Twin post hole-less. Two jacks piped together, mounted one on each side of the car with a polished steel hydraulic plunger housed in a sealed steel casing having sufficient clearance space to allow for alignment during installation each plunger shall have a high pressure sealing system which will not allow for seal movement or displacement during the course of operation. Each jack assembly shall have a check valve built into the assembly to allow for automatically re-syncing the two plunger sections by moving the jack to its fully contracted position. The jack shall be designed to be mounted on the pit floor or in a recess in the pit floor. Each jack section shall have a bleeder valve to discharge any air trapped in the section.

Automatic Self-Leveling: Provide each elevator car with a self-leveling feature to automatically bring the car to the landings and correct for over-travel or under-travel. Self-leveling shall, within its zone, be automatic and independent of the operating device. The car shall be maintained approximately level with the landing irrespective of its load.

Wiring, Piping, and Oil: Provide all necessary hoistway wiring in accordance with the National Electrical Code. All necessary code compliant pipe and fittings shall be provided to connect the power unit to the jack unit.

Pit moisture/water and oil sensor located approximately 1 foot above the pit floor to be provided. Once activated, elevator will perform “flooded pit operation”, which will run

Section Title
Number

the car up to the designated floor, cycle the doors and shut down and trip the circuit breaker shunt to remove 3 phase power from all equipment, including pit equipment.

Motorized oil line shut-off valve shall be provided that can be remotely operated from the controller landing service panel. A means for manual operation at the valve in the pit is required.

POWER UNIT

Power Unit (Oil Pumping and Control Mechanism): A self-contained unit located in the elevator pit consisting of the following items:

- NEMA 4/Sealed Oil reservoir with tank cover including vapor removing tank breather.
- An oil hydraulic pump.
- An electric motor.
- Electronic oil control valve with the following components built into single housing; high pressure relief valve, check valve, automatic unloading up start valve, lowering and leveling valve, and electro-magnetic controlling solenoids.

Pump: Positive displacement type pump specifically manufactured for oil-hydraulic elevator service. Pump shall be designed for steady discharge with minimum pulsation to give smooth and quiet operation. Output of pump shall not vary more than 10 percent between no load and full load on the elevator car.

Motor: Standard manufacture motor specifically designed for oil-hydraulic elevator service. Duty rating – motors shall be capable of 80 starts per hour with a 30% motor run time during each start.

Oil Control Unit: The following components shall be in a single housing. Welded manifolds with separate valves to accomplish each function are not acceptable. Adjustments shall be accessible and be made without removing the assembly from the oil line.

- Relief valve shall be adjustable and be capable of bypassing the total oil flow without increasing back pressure more than 10 percent above that required to barely open the valve.
- Up start and stop valve shall be adjustable and designed to bypass oil flow during start and stop of motor pump assembly. Valve shall close slowly, gradually diverting oil to or from the jack unit, ensuring smooth up starts and up stops.
- Check valve shall be designed to close quietly without permitting any perceptible reverse flow.
- Lowering valve and leveling valve shall be adjustable for down start speed, lowering speed, leveling speed and stopping speed to ensure smooth “down” starts and stops. The leveling valve shall be designed to level the car to the floor in the direction the car is traveling after slowdown is initiated.

Section Number Title

Provided with constant speed regulation in both up and down direction. Feature to compensate for load changes, oil temperature, and viscosity changes.

Solid State Starting: Provide an electronic starter featuring adjustable starting currents.

A secondary hydraulic power source (powered by 110 VAC single phase) must be provided. This is required to be able to raise (reposition) the elevator in the event of a system component failure (i.e. pump motor, starter, etc.)

HOISTWAY ENTRANCES

Doors and Frames: Provide complete hollow metal type hoistway entrances at each hoistway opening bolted\knock down construction.

- Manufacturer’s standard entrance design consisting of hangers, doors, hanger supports, hanger covers, fascia plates, sight guards, and necessary hardware.
- Main landing door & frame finish: ASTM A1008 steel panels, factory applied powder coat finish.
- Typical door & frame finish: ASTM A 366 steel panels, factory applied powder coat enamel finish.

Integrated Control System: The elevator controller to be mounted to hoistway entrance above 1st landing. The entrance at this level, shall be designed to accommodate the control system and provide a means of access to critical electrical components and troubleshooting features. The control system shall have 19 lumens of light from entrance to control panel, as well as sprinkler coverage that matches machine room requirements as the upper floor of a MRL Elevator is considered the machine room by code.

At the controller landing, the hoistway entrance frame shall have space to accommodate and provide a lockable means of access (group 2 security) to a 3 phase circuit breaker. See section 2.11 Miscellaneous Elevator Components for further details.

Interlocks: Equip each hoistway entrance with an approved type interlock tested as required by code. Provide door restriction devices as required by code.

Door Hanger and Tracks: Provide sheave type two point suspension hangers and tracks for each hoistway horizontal sliding door.

- Sheaves: Polyurethane tires with ball bearings properly sealed to retain grease.
- Hangers: Provide an adjustable device beneath the track to limit the up-thrust of the doors during operation.
- Tracks: Drawn steel shapes, smooth surface and shaped to conform to the hanger sheaves.

Hoistway Sills: Extruded metal, with groove(s) in top surface. Provide mill finish on aluminum.

Section Title
Number

CAR ENCLOSURE

Car Top Inspection: Provide a car top inspection station with an “Auto-Inspection” switch, an “emergency stop” switch, and constant pressure “up and down” direction and safety buttons to make the normal operating devices inoperative. The station will give the inspector complete control of the elevator. The car top inspection station shall be mounted in the door operator assembly.

DOOR OPERATION

Door Operation: Provide a direct motor driven heavy duty operator designed to operate the car and hoistway doors simultaneously. Door movements shall be electrically cushioned at both limits of travel and the door operating mechanism shall be arranged for manual operation in event of power failure. Doors shall automatically open when the car arrives at the landing and automatically close after an adjustable time interval or when the car is dispatched to another landing. Closed-loop, microprocessor controlled motor-driven linear door operator, with adjustable torque limits, also acceptable. AC controlled units with oil checks or other deviations are not acceptable.

- No Un-Necessary Door Operation: The car door shall open only if the car is stopping for a car or hall call, answering a car or hall call at the present position or selected as a dispatch car.
- Door Open Time Saver: If a car is stopping in response to a car call assignment only (no coincident hall call), the current door hold open time is changed to a shorter field programmable time when the electronic door protection device is activated.
- Double Door Operation: When a car stops at a landing with concurrent up and down hall calls, no car calls, and no other hall call assignments, the car door opens to answer the hall call in the direction of the car’s current travel. If an onward car call is not registered before the door closes to within 6 inches of fully closed, the travel will reverse and the door will reopen to answer the other call.
- Nudging Operation: The doors shall remain open as long as the electronic detector senses the presence of a passenger or object in the door opening. If door closing is prevented for a field programmable time, a buzzer will sound. When the obstruction is removed, the door will begin to close at reduced speed. If the infra-red door protection system detects a person or object while closing on nudging, the doors will stop and resume closing only after the obstruction has been removed.
- Limited Door Reversal: If the doors are closing and the infra-red beam(s) is interrupted, the doors will reverse and reopen partially. After the obstruction is cleared, the doors will begin to close.
- Door Open Watchdog: If the doors are opening, but do not fully open after a field adjustable time, the doors will recycle closed then attempt to open six times to try and correct the fault.
- Door Close Watchdog: If the doors are closing, but do not fully close after a field adjustable time, the doors will recycle open then attempt to close six times to try and correct the fault.
- Door Close Assist: When the doors have failed to fully close and are in the recycle mode, the door drive motor shall have increased torque applied to possibly

Section Title
Number

overcome mechanical resistance or differential air pressure and allow the door to close.

Door Protection Devices: Provide a door protection system using 150 or more microprocessor controlled infra-red light beams. The beams shall project across the car opening detecting the presence of a passenger or object. If door movement is obstructed, the doors shall immediately reopen.

CAR OPERATING STATION

Controller: Shall be integrated in a hoistway entrance jamb. Should be microprocessor based, software oriented and protected from environmental extremes and excessive vibrations in a NEMA 1 enclosure. Control of the elevator shall be automatic in operation by means of push buttons in the car numbered to correspond to floors served, for registering car stops, and by “up-down” push buttons at each intermediate landing and call push buttons at terminal landings.

Service Panel: To be located outside the hoistway in the controller entrance jamb and shall provide the following functionality/features:

- Access to main control board and CPU.
- Main controller diagnostics.
- Main controller fuses.
- Universal Interface Tool (UIT).
- Remote valve adjustment.
- Electronic motor starter adjustment and diagnostics.
- Operation of pit motorized shut-off valve with LED feedback to the state of the valve in the pit.
- Operation of auxiliary pump/motor (secondary hydraulic power source).
- Operation of electrical assisted manual lowering.
- Provide male plug to supply 110VAC into the controller.
- Run/Stop button.

Automatic Light and Fan shut down: The control system shall evaluate the system activity and automatically turn off the cab lighting and ventilation fan during periods of inactivity. The settings shall be field programmable.

Special Operation: Not Applicable.

Emergency Power Operation: (Battery Lowering 10-DOC) When the loss of normal power is detected, a battery lowering feature is to be activated. The elevator will lower to a predetermined level and open the doors. After passengers have exited the car, the doors will close and the car will shut down. When normal power becomes available, the elevator will automatically resume operation. The battery lowering feature is included in the elevator contract and does not utilize a building-supplied standby power source.

HALL STATIONS

Section Number Title

Hall Stations, General: Provide buttons with red-illuminating LED halos to indicate that a call has been registered at that floor for the indicated direction. Provide 1 set of pushbutton risers.

- Provide one pushbutton riser with faceplates having a brushed stainless steel finish.
- Phase 1 firefighter’s service key switch, with instructions, shall be incorporated into the hall station at the designated level.

Floor Identification Pads: Provide door jamb pads at each floor. Jamb pads shall comply with Americans with Disabilities Act (ADA) requirements.

Hall Position Indicator: Not Applicable.

Hall lanterns: Not Applicable.

Special Equipment: Not Applicable.

MISCELLANEOUS ELEVATOR COMPONENTS

Oil Hydraulic Silencer: Install multiple oil hydraulic silencers (muffler device) at the power unit location. The silencers shall contain pulsation absorbing material inserted in a blowout proof housing.

Lockable three phase circuit breaker with auxiliary contact with shunt trip capability to be provided. Circuit breaker to be located behind locked panel (Group 2 security access) at controller landing entrance jamb should be sized according to the National Electrical Code.

Lockable single phase 110V circuit breaker for cab light and fan to be provided. Circuit breaker to be located behind locked panel (Group 2 security access) at controller landing entrance jamb should be sized according to the National Electrical Code.

Part 3 – Execution

N/A

Section Number	Title
21 00 00	FIRE SUPPRESSION
21 10 00	WATER-BASED FIRE SUPPRESSION SYSTEMS
21 11 00	Facility Fire-suppression Water-Service Piping
21 11 16	Facility Fire Hydrants
21 20 00	FIRE-EXTINGUISHING SYSTEMS
21 22 00	Clean-Agent Fire Extinguishing Systems

Section Title
Number

21 00 00 FIRE SUPPRESSION

Part 1 – General

PLEASE REFERENCE THE NAU FIRE MARSHAL WEBSITE FOR FURTHER INFORMATION <http://nau.edu/Facility-Services/Operations/Office-of-the-Fire-Marshal/>, INCLUDING FIRE CODE.

Part 2 – Products

N/A

Part 3 – Execution

Kitchen Hood Fire Suppression Systems

System Designer: Fire suppression system plans and specifications shall be developed in accordance with NFPA 17A by persons who are experienced in the proper design, application, installation and testing of wet chemical fire suppression systems.

System Installer: Installation personnel shall be supervised by persons who are qualified and experienced in the installation, inspection and testing of fire alarm systems. Qualified personnel shall include, but not limited to, the following:

- a. Personnel who are factory trained and certified for the fire suppression installation of the specific type and brand being installed,
- b. Personnel who are certified by a nationally recognized fire suppression certification organization,
- c. Personnel who are registered, licensed or certified by a State or local authority.

System Requirements: All exposed piping, fittings, and conduit shall be chrome or chrome sleeved.

Contractor shall provide a two (2) year warranty on all system equipment and installation.

21 10 00 WATER-BASED FIRE SUPPRESSION SYSTEMS

Part 1 – General

Automatic Building Fire Suppression

Heat tracing for fire suppression piping exposed to freezing conditions will not be specified for new buildings and shall be replaced wherever possible in renovations.

Design wet pipe sprinkler systems, unless installed in areas subject to freezing.

Section Title
Number

Provide access panels for all hidden valves. Panels shall be labeled to the type of valve accessed from the panel.

Specify drain valves for each low loop of the system. Drain valves shall be piped to the exterior of the building or to a floor sink.

Part 2 – Products

N/A

Part 3 – Execution

Existing system shut-down shall be coordinated with Owner (Fire Life Safety) at 928-523-4227.

Contractor shall complete and provide: Contractor’s material and test certificate for underground, and above ground piping.

21 11 16 Facility Fire Hydrants

Owner has pre-approved the following manufacturer and product: American - Waterous Pacer.

Owner’s standard is a blue barrel and a gold bonnet. Coordinate specific colors with Owner.

Section Title
Number

21 20 00 FIRE-EXTINGUISHING SYSTEMS

21 22 00 CLEAN-AGENT FIRE EXTINGUISHING SYSTEMS

Part 1 – General

Installer qualifications: Installation contractor shall be a factory certified authorized distributor.

System designer – Fire suppression system plans and specifications shall be developed in accordance with NFPA 2001 by persons who are experienced in the proper design, application, installation, and testing of clean agent fire suppression systems.

System installer – installation personnel shall be supervised by persons who are qualified and experienced in the installation, inspection and testing of fire alarms systems. Qualified personnel shall include but not limited to, the following:

- a. Personnel who are factory trained and certified for the suppression installation of the specific type and brand being installed,
- b. Personnel who are certified by a nationally recognized fire suppression certification organization,
- c. Personnel who are registered, licensed and certified by a State or local authority.

Part 2 – Products

N/A

Part 3 – Execution

System Requirements: All detection and control/release system junction boxes shall be painted red and “J” box covers shall be labeled in bold 1” black decal letters “F/P”.

At system acceptance the Contractor shall provide all relevant manual(s), technical/maintenance manual(s), and an accurate map and AutoCAD compatible file on system component location along with device identification and address. The Contractor shall provide certificate of completion and provide two (2) copies of the complete system programming disc and sequence of events.

Contractor shall provide a two (2) year warranty on all system components, programming and installation.

Contractor shall have an in-place support facility with technical staff, spare parts inventory, and all necessary test and diagnostic equipment. Contractor shall provide 2-hour emergency response time.

Section Number	Title
22 00 00	PLUMBING
22 05 00	Common Work Results for Plumbing
22 05 17	Sleeves and Sleeve Seals for Plumbing Piping
22 05 18	Escutcheons for Plumbing
22 05 19	Meters and Gages for Plumbing Piping
22 05 23	General-Duty Valves for Plumbing
22 05 29	Hangers and Supports for Plumbing Piping and Equipment
22 05 33	Heat Tracing for Plumbing Piping
22 05 48	Vibration and Seismic Controls for Plumbing Piping and Equipment
22 05 53	Identification for Plumbing Piping and Equipment
22 07 00	Plumbing Insulation
22 10 00	PLUMBING PIPING AND PUMPS
22 11 00	Facility Water Distribution
22 11 16	Domestic Water Piping
22 11 19	Domestic Water Piping Specialties
22 13 00	Facility Sanitary Sewerage
22 13 16	Sanitary Waste and Vent Piping
22 13 19	Sanitary Waste Piping Specialties
22 14 00	Facility Storm Drainage
22 14 23	Storm Drainage Piping Specialties
22 14 29	Sump Pumps
22 30 00	PLUMBING EQUIPMENT
22 31 00	Domestic Water Softeners
22 40 00	PLUMBING FIXTURES

Section
Number

Title

22 00 00

PLUMBING

Part 1 - General

See narrative in the Design Guidelines.

Description

See Division 1 for code compliance requirements.

All pipes, fittings and valves shall be made in the USA.

Water main line pressures experienced at NAU are:

Day hours 100 psi

Night hours 150 psi

Water supply to buildings shall be regulated at 80 psi at all building entrances. Use of a pressure regulating valve at the building service entrance is required.

All pipe accessories such as backflow preventers and pressure reducing valves shall be installed with ball valves for isolation and unions for replacement. Valves and unions shall be installed both upstream and downstream of the pipe accessories.

Upon Contractors installation of backflow preventers, Contractor shall test and provide Owner (Plumbing Inspector and Project Manager) with written certification from third party testing agency.

Part 2 – Products

N/A

Part 3 – Execution

N/A

22 05 00

Common Work Results for Plumbing

22 05 17

Sleeves and Sleeve Seals for Plumbing Piping

Part 1 – General

N/A

Section
Number

Title

Part 2 – Products

Sleeves

Cast-Iron Wall Pipes: Cast or fabricated of cast or ductile iron and equivalent to ductile-iron pressure pipe, with plain ends and integral waterstop unless otherwise indicated.

Galvanized-Steel-Pipe Sleeves: ASTM A 53/A 53M, Type E, Grade B, Schedule 40, zinc coated, with plain ends.

Sleeve-Seal Systems

EPDM-rubber interlocking links shaped to fit surface of pipe.

Part 3 – Execution

Install sleeves for piping passing through penetrations in floors, partitions, roofs, and walls. Install sleeves as new horizontal or vertical surfaces are constructed.

Install sleeve-seal systems in sleeves in exterior concrete walls and slabs-on-grade at service piping entries into building.

For sleeves in floors of mechanical equipment areas or other wet areas, extend sleeve 2 inches above finished floor level.

Install sleeves for pipes passing through interior partitions.

Install sleeves that are large enough to provide 1/4 inch annular clear space between sleeve and pipe or pipe insulation. For sleeves that will have sleeve-seal system installed, select sleeves of size large enough to provide 1 inch annular clear space between piping and concrete slabs and walls.

22 05 18

Escutcheons for Plumbing

Part 1 – General

N/A

Part 2 – Products

Escutcheons

One-Piece, Cast-Brass Type with polished, chrome-plated finish and setscrew fastener.

Section Number	Title
	<p><u>Floor Plates</u> One-Piece Floor Plates: Cast-iron flange with holes for fasteners.</p> <p><u>Part 3 – Execution</u> Install escutcheons for all piping penetrations of walls, ceilings, and floors.</p> <p>Install escutcheons with ID to closely fit around pipe, tube, and insulation of piping and with OD that completely covers opening.</p>
22 05 19	<p>Meters and Gages for Plumbing Piping</p> <p><u>Part 1 – General</u> Provide data connection for metering. Coordinate requirements with Owner (NAU ITS).</p> <p><u>Part 2 – Products</u></p> <p><u>Utility Water Meters</u> Meter shall be Onicon with readability at the unit and remote through the Owner’s Energy Management System (EMS) system or approved equivalent. Meters shall be placed immediately following the main building shutoff. Isolation valves shall be placed downstream of the meter for testing. Backflows and PRVS shall be placed after the meter with a bypass around the assembly.</p> <p><u>Liquid-In-Glass Thermometers</u> Metal-Case, Industrial-Style, 9 inch nominal size cast aluminum case, adjustable angle, glass tube with magnifying lens and blue organic liquid, glass window, aluminum stem, plus or minus 1 percent of scale range or one scale division, to a maximum of 1.5 percent of scale range</p> <p><u>Thermowells</u> Pressure-tight, socket-type fitting made for insertion into piping tee fitting, copper nickel (90-10) for use with copper tubing, corrosion resistant steel for use with steel piping, stepped shank, lagging extension for insulated piping and tubing. Heat transfer medium shall be mixture of graphite and glycerin.</p> <p><u>Metal-Case, Dial-Type Pressure Gages</u> Sealed type case, 4-1/2 inches nominal diameter, bourdon tube, mechanical movement connected to pressure element and pointer, glass window, metal ring, Grade A, plus or minus 1% of middle half scale range.</p>

Section Number	Title
	<p><u>Snubbers</u> Brass; threaded, piston-type surge-dampening device. Include extension for use on insulated piping. Provide threaded, brass ball valves at each snubber.</p> <p><u>Part 3 – Execution</u> Install thermowells with socket extending one-third of pipe diameter and in vertical position in piping tees.</p> <p>Install valve and snubber in piping for each pressure gage for fluids.</p>
22 05 23	<p>General-Duty Valves for Plumbing</p> <p><u>Part 1 – General</u> N/A</p> <p><u>Part 2 – Products</u> Supply valves shall be made in USA. As an example, the following manufacturers meet this requirement: Jomar Valve, Milwaukee Manufacturing</p> <p><u>Domestic, Hot- and Cold- Water Valves</u> Pipe 2 inches and Smaller</p> <p>Ball Valves: Two piece, full port, brass or bronze with resilient seat, 150 psi, water or gas pressure rated.</p> <p>Bronze Swing Check Valves: bronze disc.</p> <p>Pipe 2-1/2 inches and Larger</p> <p>Iron Gate Valves: Class 125. Iron Swing Check Valves: Class 250, metal seats.</p> <p><u>Part 3 – Execution</u> Domestic water systems shall be zoned with shut-off capability for stacked rooms.</p> <p>Provide isolation valves for each floor and for every bathroom and all water supplied fixture.</p>

Section Number	Title
	<p>Install valve stems either vertically up or 45 degrees from vertical, horizontal or 45 degrees up from horizontal.</p> <p>Provide unions at all threaded valve connections.</p>
22 05 29	<p>Hangers and Supports for Plumbing Piping and Equipment</p> <p><u>Part 1 – General</u> N/A</p> <p><u>Part 2 – Products</u></p> <p><u>Metal Pipe Hangers and Supports</u> Carbon-Steel Pipe Hangers and Supports - Manufacturers Standardization Society of the Valve and Fittings Industry (MSS) SP-58, Types 1 through 58, factory-fabricated components, continuous-thread hanger rod, nuts, and washer made of carbon steel.</p> <p>Stainless-Steel Pipe Hangers and Supports - MSS SP-58, Types 1 through 58, factory-fabricated components, continuous-thread hanger rod, nuts, and washer made of stainless steel.</p> <p>Copper Pipe Hangers - MSS SP-58, Types 1 through 58, copper-coated-steel, factory-fabricated components, continuous-thread hanger rod, nuts, and washer made of copper-coated steel</p> <p><u>Trapeze Pipe Hangers</u> MSS SP-69, Type 59, shop- or field-fabricated pipe-support assembly made from structural carbon-steel shapes with MSS SP-58 carbon-steel hanger rods, nuts, saddles, and U-bolts.</p> <p><u>Thermal Hanger Shield Inserts</u> For trapeze or clamped systems: Insert and shield shall cover entire circumference of pipe.</p> <p>For clevis or band hangers: Insert and shield shall cover lower 180 degrees of pipe.</p> <p>Insert Length: Extend 2 inches beyond sheet metal shield for piping operating below ambient air temperature.</p>

Section
Number

Title

Equipment Supports

Welded, shop- or field-fabricated equipment support made from structural carbon-steel shapes.

Part 3 – Execution

Use carbon-steel pipe hangers and support and attachments for general service applications.

Use stainless-steel pipe hangers and stainless-steel attachments for hostile environment applications.

Use copper-plated or stainless steel pipe hangers and copper attachments for copper piping and tubing.

Use thermal-hanger shield inserts for insulated piping and tubing.

22 05 33

Heat Tracing for Plumbing Piping

Part 1 – General

Heat tracing for plumbing system is not allowed.

Part 2 – Products

N/A

Part 3 – Execution

N/A

22 05 53

Identification for Plumbing Piping and Equipment

Part 1 – General

N/A

Part 2 – Products

Equipment Labels

Brass, 0.032 inch minimum thickness, and having predrilled or stamped holes for attachment hardware.

Minimum Label Size: 2-1/2 inches by 3/4 inch

Fasteners: Stainless steel rivets fasteners

Section
Number

Title

Include equipment's Drawing designation or unique equipment number on each equipment label.

For each item of equipment to be labeled, provide tabulated equipment identification number and identify Drawing numbers where equipment is indicated (plans, details, and schedules), plus the Specification Section number and title where equipment is specified. Equipment schedule shall be included in operation and maintenance data.

Warning Signs and Labels

Multicolor, plastic labels for mechanical engraving, 1/8 inch thick, and having predrilled holes for attachment hardware.

Letter color and background color to be determined by Owner (Project Manager).

Minimum Label Size: 2-1/2 inches by 3/4 inch

Fasteners: Stainless-steel rivets

Label Content: Include caution and warning information, plus emergency notification instructions.

Pipe Labels

Self-Adhesive Pipe Labels: Printed plastic with contact-type, permanent-adhesive backing.

Pipe Label Contents: Include identification of piping service using same designations or abbreviations as used on Drawings, pipe size, and an arrow indicating flow direction.

Flow-Direction Arrows: Integral with piping system service lettering to accommodate both directions or as separate unit on each pipe label to indicate flow direction.

Lettering Size: At least 1-1/2 inches high.

Part 3 – Execution

Locate pipe labels where piping is exposed or above accessible ceilings in finished spaces; machine rooms; accessible maintenance spaces such as shafts, tunnels, and plenums; and exterior exposed locations as follows:

Section
Number

Title

Near each valve and control device.

Near each branch connection, excluding short takeoffs for fixtures and terminal units. Where flow pattern is not obvious, mark each pipe at branch.

Near penetrations through walls, floors, ceilings, and inaccessible enclosures.

At access doors, manholes, and similar access points that permit view of concealed piping.

Near major equipment items and other points of origination and termination.

Spaced at maximum intervals of **50 feet** along each run. Reduce intervals to **25 feet** in areas of congested piping and equipment.

On piping above removable acoustical ceilings. Omit intermediately spaced labels.

Coordinate labeling color coding with Owner (Project Manager).

22 07 00

Plumbing Insulation

Part 1 - General

Fire-Test-Response Characteristics: Insulation and related materials shall have fire-test-response characteristics, as determined by testing identical products per ASTM E 84, by a testing and inspecting agency acceptable to authorities having jurisdiction. Factory label insulation and jacket materials and adhesive, mastic, tapes, and cement material containers, with appropriate markings of applicable testing and inspecting agency.

Insulation Installed Indoors: Flame-spread index of 25 or less, and smoke-developed index of 50 or less.

Insulation Installed Outdoors: Flame-spread index of 75 or less, and smoke-developed index of 150 or less.

Part 2 – Products

Products shall not contain asbestos, lead, mercury, or mercury compounds.

Provide bag insulation wrap kits for angle stops, drains, P-traps and supply lines located in ADA compliant bathrooms. Owner has pre-approved the

NORTHERN ARIZONA UNIVERSITY – Technical Standards

Section
Number

Title

following product to be in compliance with these standards: TruBro insulation kits.

Mineral-Fiber, Preformed Pipe Insulation

Type I, 850 degrees F

Materials: Mineral or glass fibers bonded with a thermosetting resin. Comply with ASTM C 547, Type I, Grade A, with factory-applied ASJ-SSL.

Factory Applied Jackets

ASJ-SSL: ASJ with self-sealing, pressure-sensitive, acrylic-based adhesive covered by a removable protective strip; complying with ASTM C 1136, Type I.

Field Applied Jackets

PVC Jacket: High-impact-resistant, UV-resistant PVC complying with ASTM D 1784, Class 16354-C; Roll stock ready for shop or field cutting and forming.

PVC Jacket Adhesive

Compatible with PVC jacket.

Joint Sealants for PVC Jackets

For indoor applications, use sealants that have a VOC content of 250 g/L or less when calculated according to 40 CFR 59, Subpart D (EPA Method 24).

Part 3 – Execution

Insulate pipe elbows, tee fittings, valves and strainers using preformed fitting insulation or mitered fittings made from same material and density as adjacent pipe insulation.

Insulate flanges and unions using a section of oversized preformed pipe insulation. Overlap adjoining pipe insulation by not less than two times the thickness of pipe insulation, or one pipe diameter, whichever is thicker.

Label the outside insulation jacket of each union with the word "UNION." Match size and color of pipe labels.

Insulate instrument connections for thermometers, pressure gages, pressure temperature taps, test connections, flow meters, sensors, switches, and transmitters on insulated pipes, vessels, and equipment.

Section
Number

Title

PVC jackets shall be installed with 1 inch overlap at longitudinal seams and end joints; for horizontal applications. Apply two continuous beads of adhesive to seams and joints, one bead under lap and the finish bead along seam and joint edge.

Domestic Cold, Hot, Hot and Recirculated Hot Water Insulation shall be Mineral-Fiber, Preformed Pipe Insulation, Type I, 1 inch thick.

Install PVC jackets, 20 mils thick at pipe fitting.

****END OF SECTION****

Section Number	Title
22 10 00	PLUMBING PIPING AND PUMPS

22 11 00 Facility Water Distribution

22 11 16 Domestic Water Piping

Part 1 – General

Water lines shall not be located in outside walls, unheated attics, basements, or other unconditioned areas.

Maximum water velocity in pipes shall be 7 fps.

Part 2 – Products

Domestic water lines shall be a minimum of Type L copper.

Copper pressure-seal fittings and pressure-sealed joints shall not be specified.

Ductile iron pipe with grooved joints shall not be specified.

CPVC or PVC pipe shall not be specified.

PEX tube shall require written approval via submittal from Owner (Plumbing Supervisor).

Dielectric Fittings

General Requirements: Assembly of copper alloy and ferrous materials or ferrous material body with separating nonconductive insulating material suitable for system fluid, pressure, and temperature.

Dielectric Unions

Pressure Rating: 150 psig at 180 degrees F.

End Connections: Solder-joint copper alloy and threaded ferrous.

Dielectric Flanges

Factory-fabricated, bolted, companion-flange assembly.

Pressure Rating: 150 psig.

End Connections: Solder-joint copper alloy and threaded ferrous; threaded solder-joint copper alloy and threaded ferrous.

Dielectric Nipples

Electroplated steel nipple complying with ASTM F 1545.

Section
Number

Title

Pressure Rating: 300 psig at 225 degrees F
End Connections: Male threaded.
Lining: Inert and noncorrosive, propylene.

Domestic Water Piping Located Under Building Slab

Pipe 2.5 inches and Smaller:
Soft copper tube, ASTM B 88, Type K; and brazed joints.
PEX piping

Pipe 3 inches and Larger:
Soft copper tube, ASTM B 88, Type K; and brazed joints.

Mechanical-joint, ductile-iron pipe; standard- or compact- pattern
mechanical-joint fittings; and mechanical joints.

Domestic Water Piping Located Aboveground

Pipe 2 inches and Smaller:
Hard copper tube, ASTM B 88, Type L; wrought copper solder-joint fittings;
and soldered joints.
PEX piping.

Pipe 2-1/2 inches to 4 inches:
Hard copper tube, ASTM B 88, Type L; wrought- copper solder-joint fittings;
and brazed joints.

Pipe 5 inches to 8 inches:
No groove lock fittings allowed.

Hard copper tube, ASTM B 88, Type L; wrought- copper solder-joint fittings;
and brazed joints.

Part 3 – Execution

Domestic water system shall be flushed, checked for leaks, corrosion
inhibitors added where applicable, disinfected for domestic water and
otherwise made ready for acceptance. Notice of such tests shall be given to
Owner (Plumbing inspector).

Domestic water supply systems shall be charged with a sterilization solution
conforming to Federal Specification 0-8-441, Grade D (chlorine). Solution
shall remain in the system for 24 Hours. Comply with requirements of the
third party testing company. System shall then be flushed and test results
provided to the Owner (Plumbing inspector and Project Manager).

NORTHERN ARIZONA UNIVERSITY – Technical Standards

Project xx.xxx.xxx – Project Name

Updated 05/01/2017

13 OF 25

Section
Number

Title

Dielectric Fitting Installation

Install dielectric fittings in piping at connections of dissimilar metal piping and tubing.

Dielectric Fittings for 2 inches and Smaller: Use dielectric unions or nipples.

Dielectric Fittings for 2-1/2 inches to 4 inches: Use dielectric flanges.

22 11 19

Domestic Water Piping Specialties

Part 1 – General

Plastic Piping Components shall not be specified.

Quality Assurance

Drinking Water System Components shall comply with NSF 61.

Part 2 – Products

Vacuum Breakers

Pipe-applied, atmospheric-type.

Backflow Preventers

Intermediate atmospheric-vent backflow preventers shall not be specified.

Reduced-Pressure-Principle Backflow Preventers

Bronze body for 2 inches and smaller

Cast iron with interior lining complying with American Water Works Association (AWWA) C550 or that is FDA approved for 2-1/2 inches and larger.

Backflow preventers shall be listed as an approved assembly by the University of Southern California Foundation for Cross Connection Control and Hydraulic Research.

Owner has pre-approved the following product to be in compliance with these standards: Wilkins 975.

Water Pressure-Reducing Valves

Bronze body for 2 inches and smaller.

Section
Number

Title

Cast iron body with interior lining complying with AWWA C550 or that is FDA approved for 2-1/2 inches and 3 inches.

Temperature-Actuated Water Mixing Valves

Primary, Thermostatic, Water Mixing Valves: Recessed cabinet mounting type with union inlets and outlet.

Manifold, Thermostatic, Water-Mixing-Valve Assemblies: Recessed mounting cabinet-type, valves parallel arrangement.

Strainers for Domestic Water Piping

Bronze body for 2 inches and smaller.

Cast iron body with interior lining complying with AWWA C550 or FDA-approved, epoxy coating for 2-1/2 inches and larger.

Stainless steel screen with round perforations.

Hose-end drain valve.

Outlet Boxes

Clothes Washer Outlet Boxes: Enameled-steel or epoxy-painted-steel box and faceplate.

Icemaker Outlet Boxes: Enameled-steel or epoxy-painted-steel box and faceplate.

Hose Bibbs

Include integral vacuum breaker.

Keyless in public areas.

Wall Hydrants

Non-freeze, concealed outlet.

Automatic-draining, anti-backflow type.

Provide one operating key.

Owner has pre-approved the following product to be in compliance with these standards: Woodford Model 67.

Section
Number

Title

Part 3 – Execution

All cleanouts, meters, controllers, valves, etc. in any green belt area must be installed in boxes with removable lids. All boxes shall be concrete, flush to surface at grade.

Testing of backflow preventers shall be performed by a certified tester and results shall be submitted in writing to Owner (Project Manager). Backflow preventers and testing by certified authority per R18-4-232.

Contractor shall perform initial testing and certification on Owner's form.

Backflow preventer shall be installed as close as practicable to the service connection.

Install backflow preventer in the building mechanical room.

Install trap seal primer valves with valve outlet piping pitched down toward drain trap a minimum of 1/8 inch per foot (1 percent) and connect to floor drain body, trap, or inlet fitting. Trap primers must be accessible.

Install isolation valve and unions for each trap primer.

Install cleanouts in drain piping as required by the plumbing code and at each sewer main change in direction of 90 degrees, at minimum intervals of 50 feet for piping 4 inches and smaller and 100 foot minimum intervals for larger piping. Install cleanouts at the base of each vertical soil or waste stack. Exterior cleanouts shall be two-way.

Cleanouts shall be bullhorn type.

Extend wall cleanouts out to finished wall.

Reduced pressure backflow preventers shall be installed at service into building, at connections between potable and non-potable water systems.

Double-check backflow prevention assemblies shall be installed when a secondary backflow preventer is required to protect a specific area.

Anti-siphon, pressure type vacuum breakers shall be installed at connection to irrigation systems.

Install strainer on building potable water supply after building shut-off and

Section
Number

Title

upstream of backflow preventer.

Install ball valves with hose end threads for system drains.

Water hammer arrestors to be sized according to number of fixture units and installed between last 2 fixtures of branch with quick closing devices (e.g. flush valves, solenoid valves, etc.).

Water hammer arrestors shall be provided on both hot and cold water lines serving fixtures and equipment using flush-o-meter valves or quick-closing valves. One water hammer arrestor may serve more than one fixture. These devices must be installed in the upright position. Where utility access has not been provided, access panels shall be provided for access to maintain these devices.

Provide isolation valves for all water hammers (separate from fixture shut-off valves).

22 13 00 Facility Sanitary Sewerage

22 13 16 Sanitary Waste and Vent Piping

Part 1 – General

N/A

Part 2 – Products

Sovent stack and fittings shall not be used.

Materials

Provide flexible rubber coupling for transition between below grade and above grade piping. As an example, Fernco meets this specification. PVC, solvent weld fittings and pipe are acceptable for underground service.

Hubless, cast-iron soil pipe, service weight, and cast-iron hubless piping couplings with minimum 4 each stainless steel clamps for above grade piping.

Acid Resistant Waste and Vent (for example in laboratories) - Schedule 40 flame retardant polypropylene using socket weld fittings and electric fusion joining system.

Part 3 – Execution

Smaller than 4 inches drain piping: Install sanitary building drain piping at a

Section
Number

Title

minimum slope of 1/4 inch per foot.

4 inches and larger drain piping: Install sanitary building drain piping at a minimum slope of 1/8 inch per foot.

Install laboratory waste piping in an accessible pipeway.

Vents shall extend full size through roof and shall project 12 inches (minimum) above the roof. Use 4 lb lead jack, rolled and secured on vent stack with minimum 22 gauge chrome thickness clamp.

All waste piping exposed below sinks or fixtures shall be plastic.

22 13 19

Sanitary Waste Piping Specialties

Part 1 – General

Floor drains and sinks shall be precisely located on drawings. The location shall be such as to minimize length of drain pipes lying on the floor.

All floor drains shall be supplied with trap primers.

Part 2 – Products

Floor Drains: Cast iron body. Floor drains for use as area drains in exterior slab on grade shall be furnished with anchor flange. Inlet fittings shall be cast iron with threaded inlet and threaded or spigot outlet and trap seal primer valve connection. Airgap fittings shall be cast iron or cast bronze, with fixed air gap, inlet for drain pipe or tube, and threaded or spigot outlet. Provide seepage flange at all floor drains in suspended slabs. Provide trap primers at all floor drains.

Provide tapped trap on floor sinks and floor drains.

Floor sinks: Acid resistant enamel coated cast iron. Strainer/grating shall be chosen appropriate for service.

Part 3 – Execution

All drains, reliefs, and fire system test drains shall be piped to floor drains located by the Design Professional.

Provide floor drains for all wet areas.

Floor sinks shall be used for indirect waste only. Floor sinks shall be

Section Number	Title
	<p>installed with rim above finished floor.</p> <p>Top of floor drain grate shall be the lowest point on the floor and shall be readily drain the entire floor.</p> <p>Provide floor drains within 5 feet of all mechanical equipment which has water connections or use.</p> <p>Vending Machine Areas shall have a minimum of one floor drain or floor sink for every 10 feet of wall length. Each vending machine area shall also have a 1/2 inch (minimum) cold water line with a hose bib and atmospheric vacuum breaker at 4'-0" above the finished floor.</p>
22 14 00	Facility Storm Drainage
22 14 23	Storm Drainage Piping Specialties
	<p><u>Part 1 – General</u></p> <p>Roof drains shall be provided with heat tape for use during the winter. Complete provision shall be designed into the system for removal of the water from the site, not just the roof.</p> <p><u>Part 2 – Products</u></p> <p>Plastic roof drains shall not be specified.</p> <p>Roof Drains and Overflow Drains: Cast iron roof drain with cast metal dome strainer.</p> <p>Roof Flashing Assemblies: construct of four pound per square foot lead (min. of 24 inches x 24inches cut for drain and clamped at collar).</p> <p>Roof drains shall not be less than 4 inches.</p> <p><u>Part 3 – Execution</u></p> <p>Horizontal roof drainage pipe shall be installed at a uniform slope of not less than 1/4 inch per foot (2%) toward the point of disposal.</p>
22 14 29	Sump Pumps

Section
Number

Title

Part 1 – General

N/A

Part 2 – Products

Submersible Sump Pumps

Submersible, fixed-position, single-seal sump pumps shall be grinder pumps or approved equal.

Factory-assembled and -tested sump-pump unit.

Pump Type: Submersible, end-suction, single-stage, close-coupled, overhung-impeller, centrifugal sump pump as defined in American National Standards Institute/Hydraulic Institute (ANSI/HI) 1.1-1.2 and HI 1.3.

Pump Casing: Cast iron, with strainer inlet, legs that elevate pump to permit flow into impeller, and vertical discharge for piping connection.

Impeller: Statically and dynamically balanced, ASTM A 48/A 48M, Class No. 25 A cast iron, semi-open design for clear wastewater handling, and keyed and secured to shaft.

Pump and Motor Shaft: Stainless steel, with factory-sealed, grease-lubricated ball bearings.

Seal: Mechanical.

Motor: Hermetically sealed, capacitor-start type; with built-in overload protection; lifting eye or lug; and three-conductor, waterproof power cable of length required and with grounding plug and cable-sealing assembly for connection at pump.

Sump Pump Basins and Basin Covers

Basins: Factory-fabricated, watertight, cast, iron, cylindrical, basin sump with top flange and sidewall openings for pipe connections.

Basin Covers: Fabricate metal cover with openings having gaskets, seals, and bushings; for access to pumps, pump shafts, control rods, discharge piping, vent connections, and power cables.

Reinforcement: Steel or cast iron, capable of supporting foot traffic for basins installed in foot-traffic areas.

Section
Number

Title

Part 3 – Execution

N/A

****END OF SECTION****

Section Number	Title
22 30 00	PLUMBING EQUIPMENT
22 31 00	Domestic Water Softeners

Part 1 – General

Warranty: There shall be a mineral loss guarantee of a minimum of three years.

Part 2 – Products

Softener tanks and systems shall be fabricated with fiberglass, PVC, steel or similarly durable lining guaranteed for a minimum of five years service.

Water softener control valves shall be equipped with "service" and "regeneration" lights.

Owner has pre-approved the following manufacturers to be in compliance with these standards: Water King Water Softeners.

Part 3 – Execution

Install commercial water softeners on concrete base. Maintain manufacturer's recommended clearances. Arrange units so controls and devices that require servicing are accessible.

After installation, charge system and test for leaks. Repair leaks and retest until no leaks exist.

Calculate discharge flow and ensure floor sink/drain and piping are adequately sized.

22 35 00	Domestic Water Heater Exchangers
-----------------	---

Part 1 – General

N/A

Part 2 – Products

N/A

Part 3 – Execution

Contractor is required to provide a submittal to Owner for approval.

****END OF SECTION****

Section
Number

Title

22 40 00

PLUMBING FIXTURES

Part 1 – General

All fixtures shall be ADA compliant.

Quality Assurance

Quality Standard: NSF 61 for fixture materials in contact with potable water.

Quality Standard for Electrical Components, Devices, and Accessories:
NFPA 70, Article 100.

Part 2 – Products

Maximum Flow Rates

Plumbing fixtures shall be low flow meeting the standards identified in Arizona State Governor's Executive Order 91-3 at a minimum.

Toilets: 1.25 gallons per flush. No electronic flushometers are allowed.

Urinals: 0.125 gallon per flush. No electronic flushometers are allowed.

Sinks shall have grid strainers in residence room areas and plastic p-traps for public areas.

Lavatory faucets: 0.5 gallon per minute, Single Handle.

Kitchen faucets: 1.0 gallon per minute.

Other faucets: 0.5 gallons per minute.

Showerheads: 2.5 gallons per minute. Showerheads shall be tamper resistant.

Manufacturers

Contractor shall provide a submittal on the plumbing fixture manufacturer.

Fixtures in a building shall be of one manufacturer for each fixture type (i.e. all lavatory faucets shall be the same brand, all urinals shall be the same brand, etc.).

Shower/Lavatory/Kitchen faucets: Owner has pre-approved the following manufacturer to be in compliance with these standards:

NORTHERN ARIZONA UNIVERSITY – Technical Standards

Section
Number

Title

- Delta, single handle, ADA compliant, pressure & temperature balanced.

Urinals: Owner has pre-approved the following manufacturer/product to be in compliance with these standards:

- Zurn Z5750.

Shower Heads: Owner has pre-approved the following manufacturers to be in compliance with these standards:

- Chatham model 10-2S; #2120 MN as manufactured by Niagra Products (1-800-831-8383);
- "Osage Showerhead" as manufactured by Whole Energy and Hardware (1-800-544-2986); or equal.

Custodial and Laboratory faucets: Owner has pre-approved the following manufacturer to be in compliance with these standards:

- Chicago, with vacuum breaker.

No substitutions shall be allowed for the following valves. Owner has standardized the campus in order to stock the required parts: Flush valves: Zurn.

Water fountains and bottle fillers

The quantity and accessibility of water fountains and bottle fillers shall comply with IPC and IBC code.

Not every water fountain is required to be a combination bottle filler, but bottle fillers (with or without combination fountains) shall be available in high-traffic areas. Quantity and location of bottle fillers will be coordinated with Owner.

Water fountains and bottle fillers shall include filtration systems with filter replacement indicator lights. New fixtures shall be installed with a new filter. Water fountains and bottle fillers shall include integrated chillers to deliver 50°F drinking water. In the event the domestic water supply is below this temperature, fixtures without cooling systems can be coordinated with Owner.

Water fountains shall be equipped with vandal-resistant bubblers and front/side pushbar controls.

Section
Number

Title

Individual Shower Units

ADA accessible shower units shall require pressure and temperature balancing type single-handed shower valve assembly with screwdriver stops, wand type shower head on flexible hose attached to arm on shower walls. Internal grab bars and seat shall be included in the assembly.

Prefabricated fiberglass shower enclosures shall be utilized which have full height walls, grout backed shower floors, and integral braces for rigidity.

Part 3 – Execution

Custodian closets shall have floor service sinks. If fire sprinkler system test valves drain into these, they must accept the full flow of the test.

All sinks, lavatories and wash basins shall have chrome plated stops with gasket seats.

All exposed branch water supply piping in toilet rooms and custodial rooms shall be chrome-plated.

****END OF SECTION****

DIVISION 23 – HEATING, VENTILATING, AND AIR-CONDITIONING (HVAC)

Section Number	Title
23 00 00	HEATING, VENTILATING, AND AIR-CONDITIONING (HVAC)
23 05 00	Common Work Results for HVAC
23 05 13	Common Motor Requirements for HVAC Equipment
23 05 16	Expansion Fittings and Loops for HVAC Piping
23 05 19	Meters and Gauges for HVAC Piping
23 05 23	General-Duty Valves for HVAC Piping
23 05 93	Testing, Adjusting, and Balancing for HVAC
23 09 00	Instrumentation and Control for HVAC
23 20 00	HVAC PIPING AND PUMPS
23 21 00	Hydronic Piping and Pumps
23 21 13	Hydronic Piping
23 21 23	Hydronic Pumps
23 22 00	Steam and Condensate Piping and Pumps
23 22 13	Steam and Condensate Heating Piping
23 23 00	Refrigerant Piping
23 30 00	HVAC AIR DISTRIBUTION
23 31 00	HVAC Ducts and Casings
23 31 13	Metal Ducts
23 34 00	HVAC Fans
23 34 16	Centrifugal HVAC Fans
23 36 00	Air Terminal Units
23 38 00	Ventilation Hoods
23 38 13	Commercial-Kitchen Hoods
23 50 00	CENTRAL HEATING EQUIPMENT
23 52 00	Heating Boilers
23 57 00	Heat Exchangers for HVAC
23 60 00	CENTRAL COOLING EQUIPMENT
23 62 00	Packaged Compressor and Condenser Units
23 64 00	Packaged Water Chillers
23 64 23	Scroll Water Chillers
23 65 00	Cooling Towers

DIVISION 23 – HEATING, VENTILATING, AND AIR-CONDITIONING (HVAC)

Section Number	Title
23 70 00	CENTRAL HVAC EQUIPMENT
23 73 00	Indoor Central-Station Air-Handling Units
23 73 13	Modular Indoor Central-Station Air-Handling Units
23 74 00	Packaged Outdoor HVAC Equipment
23 74 13	Packaged, Outdoor, Central-Station Air-Handling Units
23 80 00	DECENTRALIZED HVAC EQUIPMENT
23 81 00	Decentralized Unitary HVAC Equipment
23 81 26	Split-System Air-Conditioners
23 82 00	Convection Heating and Cooling Units
23 82 16	Air Coils
23 83 00	Radiant Heating Units
23 83 13	Radiant-Heating Electric Cables
23 83 16	Radiant-Heating Hydronic Piping

Section
Number

23 00 00 HEATING, VENTILATION, AND AIR CONDITIONING (HVAC)

Part 1 – General

Building System Design Criteria

HVAC Baseline

An HVAC system with which the Owner has considerable long-term operating experience and considers the baseline system is described as follows:

Central Utility Connections

Utilizes Owner's central heating and cooling distribution systems.

Building Core

Single Duct, indoor unit with terminal reheat variable air volume boxes.

Ducted return.

Digital controls on air handler and terminal devices.

Full outside air enthalpy based economizer with return/relief and outside air dampers.

Single Class II supply fan selected and sized with fan speed less than 1500 RPM.

Air side pressure drop external to unit less than 1.5 inch water column.

Heating coils and terminals utilizing building heating water loop.

For systems with nominal outside air requirement in excess of 50%, a separate glycol loop to preheat coil is allowed.

Air to Air heat recovery for systems operating year around with more that 50% outside air.

Air handler freeze stat with manual reset

Chilled water cooling coil and/or direct evaporative section with face and bypass dampers are included. Cooling components sized for operation at less than 450 fpm face velocity.

Section
Number

Title

Building Perimeter

Fin tube or convector units with sufficient tube surface to satisfy full heating load with 160 F heating water supply.

Life Cycle Cost Analysis

Consider alternative HVAC systems that offer the potential of substantial improvement in energy efficiency, maintainability, first cost, or a legitimate potential to better achieve the Owner’s sustainability goals. A lifecycle cost analysis that compares a proposed alternative system against the baseline system shall be provided for all energy consuming HVAC systems and sub-systems and shall conform to the requirements of Arizona Revised Statute §34-454. Life cycle costs shall be calculated based on owning, operating, and maintaining each system. Included are such factors as initial construction cost, fuel, energy, maintenance labor, replacement consumables and components, long term cost of service, and estimated useful service life. Electrical rates used in life cycle cost analysis shall be actual demand and consumption costs, not average costs. These can be requested from Owner.

The baseline system described above shall be among the alternatives compared. The life cycle is the expected life of the system, or twenty-five years, whichever is shorter. Technical and economic assumptions used in life cycle cost analysis shall be coordinated with Owner (Project Manager) prior to submittal of result. Life cycle cost will be one of several criteria used by Owner in accepting use an alternative HVAC system. Other criteria include demonstration that the system or product proposed has been in satisfactory service in similar applications and environments for at least three years, necessity of special training or maintenance skills by Owner, local availability of service parts and track record of vendor or service contractor in resolving issues raised during and after the warranty period. Quality of environmental control may be a factor. Owner reserves the right to reject alternative system proposals.

The suitability of using evaporative cooling, whether alone or in addition to a mechanical or indirect evaporative system, shall be evaluated. For wet wall installations, face and bypass dampers must be used for temperature control. Wet wall pump cycling shall not be an option for temperature control. Bypass dampers shall be sized to allow full air flow around the wet wall. Where possible, evaporative cooling will be among cooling alternatives considered in life cycle cost analysis.

The use of any electrical source heating equipment, including heat pumps, heat tape, baseboard heat, and electric domestic hot water heaters, shall not be considered unless a minimum of 25 year life cycle cost analysis of all alternatives

DIVISION 23 – HEATING, VENTILATING, AND AIR-CONDITIONING (HVAC)

Section
Number

Title

demonstrates it to be the most cost effective for the 25 year life cycle. The determination of energy costs must include both kwh and demand charges.

System sizing

All utility service and supply systems, including, but not limited to, steam, high temperature hot water, natural gas, domestic water, waste, and electrical, shall be sized for peak anticipated demand throughout the project and shall be sized as far back as the main meter or central distribution system. The adequacy of any central distribution system to carry all added peak loads shall be determined by the Design Professional, and no loads shall be connected to any such system that is determined to be undersized. Calculations demonstrating adequacy of existing infrastructure shall be provided to Owner with drawing submissions.

HVAC Design Requirements

Owner requires low pressure, low velocity (2000 FPM max, 2 inches WG max) air distribution systems. Designs involving higher velocity and/or pressure shall be reviewed and approved in writing by Owner (PM and HVAC department).

Noise level volumes of air movement and equipment shall be designed and installed as compatible for intended functions within building spaces. The Design Professional is responsible for designing systems that maintain acceptable sound levels as defined by ASHRAE.

The Design Professional shall evaluate the potential for overheating of building spaces. Particular attention shall be paid to areas which house computer or other electronic equipment. Evaluation shall consider all factors including but not limited to equipment, passive solar gain, and occupant loads. Where such potential exists, the value and cost effectiveness of mechanical cooling shall be analyzed.

All mechanical rooms shall be ventilated. Location and size of louvers and vents to the outside shall be coordinated with piping and equipment to preclude the possibility of thermal stratification and/or freeze up. Any ventilated space which houses water piping, vessels, or equipment, such as equipment rooms, shall be heated to a minimum of 50° F. When equipment rooms must be ventilated to provide boiler combustion air, the heat source shall be independent of the boiler. Provision for temporary mechanical ventilation shall be provided in vaults and chases that are not normally accessible.

All mechanical rooms and spaces shall be adequately sized, lighted and arranged so that any and all repair and maintenance that may be necessary can be performed. Owner prefers main air handling, heat exchangers, and pump

DIVISION 23 – HEATING, VENTILATING, AND AIR-CONDITIONING (HVAC)

Section
Number

Title

equipment to be floor mounted. Controls, mixing boxes, balance dampers, fire dampers, valves, filter banks, heat exchanger coils, pumps, belts, etc., shall be accessible for repair or replacement, and shall not be obstructed by any pipe, conduit, or other obstacle. Heat exchanger tube bundle and coil pull space shall be provided and shown graphically on the design drawings, along with vendor required service space for all HVAC equipment and Code required clearance for all electrical equipment and panels. Where possible, mechanical rooms are to be located at grade, on an exterior wall, and provided with an exterior door of sufficient size to move the largest piece of equipment through. Equipment rooms not located at grade shall be provided with a conventional access stair or elevator. Access to mechanical equipment room by means of a ladder is not acceptable. Access for handling component replacement, such as motors, shafts, drives and coils shall be provided. Where equipment must be raised vertically through a hatch, a structurally designed overhead lifting beam of sufficient capacity shall be provided. Main air handling equipment must have a catwalk with permanent ladder and overhead lifting beam, if not floor mounted.

Ample minimum access shall be provided to overhead mechanical equipment, such as in-line exhaust fans, terminal boxes, or fan coil units and shown graphically on design drawings. Ample minimum access is defined as access that is sufficient to allow 2' 6" of clearance in front of a service technicians head when standing on a ladder with shoulders at the level of the equipment.

Gauges, thermometers, and isolation valves shall be specified for all HVAC equipment.

No underground storage tanks of any type shall be specified without signed prior approval by Owner (Director of Utilities).

Part 2 - Products

Quality Assurance

The selection of products or service companies shall be from those firms whose products or services have proven satisfactory in similar service for not less than three years. Repair or replacement parts, or required service, shall be readily available, and the supplier of products or services shall have a proven track record of response to complaints or problems during, and after, the warranty period.

All parts or products shall be of commercial or industrial quality, and shall be suitable for heavy-duty use.

DIVISION 23 – HEATING, VENTILATING, AND AIR-CONDITIONING (HVAC)

Section
Number

Title

Contractor shall provide one (1) set of filters installed just prior to final balancing.

Part 3 – Execution

Quality Assurance

Experienced, qualified personnel shall be on the job. Experience and qualifications are defined by three years of experience in installation of similar equipment on similar projects. All subcontractors shall have a proven track record of response to complaints or problems during and after the warranty period. Proof of experience is required before the start of work.

Design Document Requirements

The Design Professional shall submit a set of mechanical floor layout drawings at the Schematic and again at the Design Development stage. Locations and sizes of major HVAC equipment, including fans, air handlers, pumps, heat exchangers and steam control stations will be shown on these drawings along with electrical equipment and panels. Mechanical floor layout drawings will demonstrate code clearances along with **maintenance and service access**.

The Design Professional shall provide a process and instrumentation diagram drawing at Design Development and Construction Documents depicting all pressure gauges, thermometers and flow meters required for the project. Included on this drawing shall be actual design flows pressures and temperatures for each and every system.

Submittal Information and Closeout Materials

Sequence of control diagrams shall be required to be submitted within 21 days of notice to proceed.

Provide Shop Drawings and product data prior to start of construction as applicable for the following:

- Equipment room layouts, drawn to scale, showing all equipment, piping and accessories and clearances for operation and servicing.

Provide submittal information including equipment cut sheets for at a minimum, the following components and equipment:

- All HVAC equipment including boilers, heat exchangers, pumps, tanks, valves, hangers, air handlers, filters, louvers and dampers, relief valves, strainers, traps and drip legs, etc. All terminal equipment including volume control boxes, registers, grills, diffusers, etc.
- Design curves and characteristics of fans, blowers and pumps.

DIVISION 23 – HEATING, VENTILATING, AND AIR-CONDITIONING (HVAC)

Section
Number

Title

- Control diagrams and sequence of operations for all HVAC equipment.
- HVAC and motor control wiring or pneumatic diagrams.
- Plumbing fixture cuts, trim and fittings, rough-in dimensions and special supports.
- Plumbing fixtures, equipment and specialties.
- Piping materials, fittings, specialties.
- Expansion loops, joints, guides, and anchors.
- Foundations, supports, hangers and inserts.
- Drains (roof/floor) carriers, cleanouts, downspout nozzles.
- Insulation materials and finishes, duct and piping.
- Mechanical identification.
- Converters with saddles and relief valves.
- Gauges and thermometers.
- Flow fittings.
- Utility sets with vibration isolation.
- Dampers - back draft, volume, smoke, fire, combination smoke/fire.
- Temperature control equipment, schematics and diagrams.
- Panel boards, gauges and thermometers.
- Fire protection system - hydraulic calcs.
- Fire protection equipment and specialties (wet, dry and chemical).
- Wiring diagrams and motor control equipment. (Wiring diagrams must be project specific, manufacturer's standard diagrams will not be accepted).
- Pressure testing procedure

Provide attic stock as applicable from the following:

- Two (2) sets keys/wrenches for any covers.
- Chemical test kits as appropriate.
- One (1) extra set of filters.
- One (1) set of any proprietary trouble shooting, maintenance tools, or specialty tools.
- Two (2) copies any proprietary computer software for systems control, program back-up, troubleshooting or maintenance.
- Reference Owner form FS #76 – Attic Stock, Warranty, As-built Log for additional requirements.

Provide Manufacturer's certificates or test results for the following:

- Air balance reports.
- Heat exchangers.
- Boilers and chillers

DIVISION 23 – HEATING, VENTILATING, AND AIR-CONDITIONING (HVAC)

Section
Number

Title

- Chemical treatment products, application limits, test methods, and apparatus.
- Glycol mixing formula.
- Backflow preventers (per R18-4-232).
- Potable water system purification.
- Hydrostatic test on sprinkler system.
- Hydronics balancing.
- Field test make up air units and fans.
- Final inspection from Mechanical Engineer.

Other Closeout Requirements to Provide:

- 1 - 3 day start-up training as applicable (coordinated with Facility Services.)
To be videotaped by the University.
- Valve tag index mounted under rigid clear protection in the mechanical room(s) and diagram submitted with the O & M manuals.
- Hard copies of all control codes and sequence of operations.

Warranty

Owner's standard 2-year warranty. Reference Owner form FS #76 – Attic Stock, Warranty, As-built Log for additional requirements.

****END OF SECTION****

DIVISION 23 – HEATING, VENTILATING, AND AIR-CONDITIONING (HVAC)

Section
Number

23 05 00 Common Work Results for HVAC

23 05 13 Common Motor Requirements for HVAC Equipment

Part 1 – General

Section includes general requirements for single-phase and poly-phase, general-purpose, horizontal, small and medium, squirrel-cage induction motors for use on ac power systems up to 600 V and installed at equipment manufacturer's factory or shipped separately by equipment manufacturer for field installation. All motors shall be high efficiency with sizing and winding insulation specified to compensate for altitude (7,000 ft).

Part 2 – Products

All motors shall be Premium Efficiency.

Part 3 – Execution

All pump motors located remote from the motor control center shall have a local disconnect that may be locked out.

23 05 16 Expansion Fittings and Loops for HVAC Piping

Part 1 – General

Design Professional shall calculate thermal pipe stress and design compensation system. Pipe stress analysis of steam and high temperature hot water system to be sealed by Design Professional and submitted to Owner.

Construction drawings shall contain sufficient detail to clearly identify location and method of support for pipe anchors, thrust blocks, guides, expansion compensators, arresters, etc.

Part 2 – Products

Steam/Condensate distribution system:

Owner has pre-approved the following product to be in compliance with these standards: Hyspan 3500 externally pressurized bellows joint.

High Temperature Heating Water systems:

Owner has pre-approved the following product to be in compliance with these standards: Barco Ball Joint.

Part 3 – Execution

All products to be installed per manufacturer's recommendation.

DIVISION 23 – HEATING, VENTILATING, AND AIR-CONDITIONING (HVAC)

Section
Number

23 05 19 Meters and Gauges for HVAC Piping

Part 1 – General

N/A

Part 2 – Products

Pressure Gauges

Specify 6" minimum diameter, liquid filled gauges with snubbers, stand offs and isolation cocks. Pressure gauges shall normally read at 60% of total gauge pressure capability. Pressure gauges shall be required on all inlet and outlet lines of the following:

- Boilers
- Converters
- Pumps – Only inlet
- Main steam supply line
- Static pressure gauges on all static controlled fans

Thermometers

Thermometers to be provided on all of the following:

- Air Handlers (mixed air, hot deck, cold deck)
- Boilers
- Converters
- Cooling equipment, chillers
- Heat recovery systems
- Heat transfer coils with pipe size greater than 2 inches.
- Building chilled water point of entry and exit.

Part 3 – Execution

Provide air vent in pipe riser. Install automatic air vents in equipment rooms and manual air vents elsewhere, with isolation valve at all system high points and piped to drain. Minimum vent piping size is 1/2 ".

23 05 23 General Duty Valves for HVAC Piping

Part 1 – General

N/A

Part 2 – Products

Valve Requirements:

DIVISION 23 – HEATING, VENTILATING, AND AIR-CONDITIONING (HVAC)

Section Title
Number

<u>Service</u>	<u>Size</u>	<u>Type</u>	<u>Material</u>	<u>Connections</u>
Natural Gas (inside building)	All	Ball Valve	Iron or Bronze Body	Threaded
Hydronic Piping	Thru 2.5"	Ball	Bronze Body	Threaded
2.5" & Larger		Butterfly	Iron Body with Bronze Disk	Lug Type flange
Steam	Thru 2"	Ball	Bronze Body	Threaded
Steam	Above 2"	HP Butterfly	Carbon Stl Body	Lug type flange
Condensate	All	Ball	Bronze Body	Threaded
HTHW	All	Ball on HP Butterfly	Stainless Steel	Lug Type Threaded

Steam valves and steam pressure regulators.

Owner has pre-approved the following manufacturers to be in compliance with these standards: Manufactured by Fisher (TYPE 92B).

Ball valves shall be 100% full port, full line size.

Butterfly valves to have 100% bubble tight-shut-off and full port sizing.

Valves shall be domestic manufacturer. Owner has pre-approved the following manufacturer to be in compliance with these standards: Milwaukee.

Provide and secure brass identification tags to all valves. Incorporate in valve tag index.

Automatic Valves

All automatic valves must be able to communicate with the Owner's Building Management System (BMS). Owner has pre-approved the following manufacturers to be in compliance with these standards: Belimo.

Part 3 – Execution

Install all valves for easy access for operation, repair and maintenance without use of ladders. Chainwheels are required where floor access to valve handle is not possible and valves are 4" and over and located 7'0" AFF.

DIVISION 23 – HEATING, VENTILATING, AND AIR-CONDITIONING (HVAC)

Section
Number

Title

Isolation valves shall be at all equipment and on all main branch take-offs.

Automatically controlled heating valves shall fail to heat (normally open).
Domestic steam and HTHW valves shall fail closed.

Unions shall be installed on the downstream side of all non-flanged valves for access and repair of systems.

Provide isolation valves on each side of strainers and full port ball valve on blow down.

Provide ball valves with hose end threads for system drains and strainer blow down.

When an existing system “hot tap” is necessary, specify a full port ball valve to isolate the new branch line.

Do not use circuit setter as isolation valve.

Provide relief valves on piping and equipment as needed to meet code requirements.

Provide plug cock valves at connections to gas-fired equipment and in all branch piping.

23 05 93

Testing, Adjusting, and Balancing for HVAC

Part 1 – General

Test and Balance Firm Considerations

The Contractor shall hire the test and balance firm, but shall have approval from Owner on who they receive bids from and who they contract with.

The air distribution system shall be tested and balanced by an independent firm licensed, bonded and certified to perform such work in the State of Arizona.

The work of the test and balance contractor shall be specified in the Construction Documents by the Design Professional.

Design and Specification Considerations

The air flows shall be specified to be set within 3% of the design requirements.

DIVISION 23 – HEATING, VENTILATING, AND AIR-CONDITIONING (HVAC)

Section
Number

Title

All air distribution systems shall be balanced in the heating mode and have flows measured in cooling mode.

The Design Professional shall specify all the necessary dampers, controls and sheaves required to meet the balance conditions.

The Design Professional shall specify final mechanical system noise levels that are to be compatible with intended functions within the building spaces.

The final air balance will be conducted after all systems are in place and operational and have been accepted.

All systems start-up, testing, balancing, Final Operations & Maintenance Manuals and training shall be completed on or before, and is a requirement of, Substantial Completion.

Test and Balance Submittal Requirements

Contractor shall submit test and balance firm's certifications along with a test and balance plan including but not limited to where test points shall be taken, any traverse test being performed, and any potential complications.

The testing agency shall provide verification that systems operate at 50% to 75% and at 100% capacity as designed.

Final balance report shall include copies of pump and fan curves.

Part 2 – Products

N/A

Part 3 – Execution

N/A

23 09 00 Instrumentation and Control for HVAC

Part 1 – General

Design Considerations

Heating Ventilating and Air Conditioning system design shall be zoned to differentiate between north, south, east and west exposures, internal areas, locations of large glass areas with independent controls for each zone, and shall include outside air and zone temperature reset, and solar gain compensation.

DIVISION 23 – HEATING, VENTILATING, AND AIR-CONDITIONING (HVAC)

Section
Number

Title

A maximum of 4 individual rooms shall be ganged on a single thermostatically controlled temperature zone, provide the rooms have compatible exposure, occupancy and setpoint conditions, unless otherwise approved by Owner in writing.

Indoor space temperatures shall be specified to be maintained at a maximum of 69° F. in a heating mode, as measured 4' above the floor and 2' from the exterior wall shielded from the sun and artificial heat sources.

Indoor space temperatures shall be specified to be maintained at a minimum of 75° F. in a cooling mode as measured 4' above the floor and 2' from any exterior walls.

Large classrooms/conference rooms shall have reasonable sampling of the temperature.

In general, air handlers shall be configured with 100 % outside air economizers using enthalpy based control logic.

Temperature sensors for outside air, return air, mixed air on each air handler or variable box are required

Sufficient instrumentation that energy efficiency can be trend monitored is required. This includes filter pressure gauges, air handler valve and damper position feedback, terminal box flow, temperature and valve position, VFD speed indication, running amps of large motors and motor driven equipment

Every building control system shall integrate with Owner's head end, located in the HVAC department. Every Contractor is required to furnish all labor, hardware and applicable software and graphics necessary to integrate and maintain the system.

Design Submittal Requirements

Design Professional shall write a detailed sequence of operations in plans. Any proposed changes to the sequence shall be done through a RFI and included in the as-builts and controls O&M's.

Design Professional submittals shall include:

- Piping and Instrumentation Diagram, Control System
- Control system architecture diagram
- Points list
- Control component specification

DIVISION 23 – HEATING, VENTILATING, AND AIR-CONDITIONING (HVAC)

Section
Number

- EMS sequence of operation

Control system architecture diagram shall depict in single line the communication interfaces between campus head end, building energy management, air handler and plant controllers and all terminal controllers, along with interface to building metering and monitoring devices.

Installation of control systems shall not proceed without sign off approval of sequence of operations and control diagrams and shop drawings by Owner (HVAC inspector).

Part 2 – Products

All direct digital controls (DDC) shall be native BACnet and fully communicate with Owner's existing system. The control component manufacturer is Alerton.

Wireless access is to be provided in mechanical and electrical rooms for technician access to the campus head end.

Major equipment such as Chillers, Boilers, VFDs, Fume Hood and Room/Lab Pressurization systems shall be fully integrated and communicate with the BACnet DDC System. Hardwire start/stops are required.

Factory set (pre-programmed) HVAC control modules are not acceptable. Proportional authority percentage (re-set) shall be field adjustable.

Sequence of operations and control diagrams and shop drawings require sign off approval by Owner (HVAC department) prior to installation and programming.

Part 3 – Execution

The controls contractor shall be a first tier sub to the Contractor.

Maintenance training sessions shall be provided on all systems. All sessions shall be scheduled through Owner (Project Manager). Sessions shall be video recorded by the Contractor and given to Owner.

All required close-out diagrams, sequence of operations and O/M manuals shall be on-site and available at the time of the scheduled training sessions. All training shall be completed in such a manner to assure proper end-user competency.

Training shall include both on-site, in-building efforts and remote site training at Control contractor's facility.

DIVISION 23 – HEATING, VENTILATING, AND AIR-CONDITIONING (HVAC)

Section
Number

Title

Controls contractor shall set up all trends required by commissioning on energy management components listed in part 1 of this section, meter instantaneous demand and totalized usage, and all space temperature setpoints. The Design Professional or Commissioning Agent may indicate additional trends in the project specifications.

Air handling systems shall be provided with freeze protection controls which are hardwired for failsafe operation as well as controlled by the DDC system. Fail safe, hardware protection shall include a manually reset low temperature switch, freeze-stat, activated by a sensor, capillary tube, downstream of the preheat or heating coil or between the heating coil and the chilled water coil which drives outside air damper close, opens heating hot water valve and opens chilled water valve and shuts down the fan. Access doors shall be provided for low temperature switch, freeze-stat, for removal and service.

Pneumatic Control Systems

When removing sections of pneumatic installations the piping shall be taken back to the point of origin and capped.

****END OF SECTION****

DIVISION 23 – HEATING, VENTILATING, AND AIR-CONDITIONING (HVAC)

Section Number	Title
23 20 00	HVAC PIPING AND PUMPS
23 21 00	Hydronic Piping and Pumps
23 21 13	Hydronic Piping

Part 1 – General

This Section includes pipe and fitting materials, joining methods, special-duty valves, and specialties

Part 2 – Products

Pipe Requirements - Above Ground

Size	Pipe	Fittings	Joints
Up to 2"	Copper Type "L" seamless hard drawn	Wrought copper	Less Than 0.2% Lead Alloy Solder
2 1/2" larger	Copper Type "L" seamless hard drawn	Wrought copper	15% silver brazed
	Or	Or	Or
Schedule 40 Black Steel		Forged carbon steel	bevel welded
Pipe Schedule BelowGround			
Up to 2" Seamless hard drawn	Copper Type "K"	Wrought Copper	6% silver brazed
2-1/2" Seamless hard drawn	Copper Type "K"	Wrought Copper	15% silver brazed

Press fit coupling systems such as ProPress are not allowed without express written permission of Owner (Project Manager and HVAC Supervisor).

Pipe Gasketing – Steam and High Temperature Hot Water Services

Dialectric nipples shall be installed whenever joining dissimilar metals. Dialectric unions are not to be used. Spiral Wound. Owner has pre-approved the following manufacturer to be in compliance with these standards: Flexitallic gaskets.

DIVISION 23 – HEATING, VENTILATING, AND AIR-CONDITIONING (HVAC)

Section
Number

Title

Expansion Tanks

Provide diaphragm-type compression tank with replaceable diaphragm.

Part 3 – Execution

Copper: Maintain a minimum of 50% penetration of brazed joints.

Steel: Perform a minimum of three passes on weld joints (root, filler, cap).

Route piping to allow sufficient access to all equipment, valves, controls, etc., for maintenance. Install all equipment, valves, controls, etc. in a manner to perform maintenance from the deck.

In general, piping shall be installed below electrical conduits not requiring maintenance access.

All chilled water coils and DX coils located in a fan coil unit above the ceiling shall have a secondary drain pan under the fan coil unit. The secondary drain pan shall drain to a custodial sink. Such piping shall be directly connected to the secondary drain pan and maintain a minimum horizontal slope in direction of discharge of not less than one-eighth unit vertical in 12 units horizontal (1-percent slope).

Piping shall be secured at each trapeze hanger or support.

All hydronic piping, heating hot water or chilled water shall not be exposed to the weather elements; all piping shall be within the building structure.

Install piping sufficiently below structure to allow top air vents.

Provide isolation valves on each side of strainers and full port ball valve on blow down. Provide hose thread connection on blow down port 3/4" and below.

Provide air vent in pipe riser. Install air vents with isolation valves at all system high points. Automatic air vents are to be piped to drain. Minimum vent piping size is 1/2".

Piping Systems Flushing and Testing

Each system (steam, water, condensate, etc.) shall be flushed, checked for leaks, corrosion inhibitors added where applicable, and otherwise made ready for acceptance.

DIVISION 23 – HEATING, VENTILATING, AND AIR-CONDITIONING (HVAC)

Section
Number

Title

Testing on all backflow preventers is required. Testing shall be performed by a certified tester and results shall be submitted in writing to Owner on the NAU Facility Services Backflow Testing form.

Solution shall remain in system (8) Hours. System shall then be flushed and test results provided to the Owner (Inspector).

All pressure tests shall be performed using a certified gauge which has been approved for use by Owner (Inspector).

Pressure testing needs to be conducted on the new system only. The new system needs to be isolated from the existing system during the pressure testing.

Pressure test the new system at whichever is higher between 1.5 times the operating pressure or as code requires for a period of two hours. A testing procedure needs to be submitted to the Owner (HVAC Supervisor) and approved prior to any testing.

23 21 23

Hydronic Pumps

Part 1 – General

Dual system back-up pumps shall be specified and installed on all new building and water heating and cooling systems. All heating, cooling, and domestic hot water circulation pumps shall have back-up. Automatic switch over in case of failure is to be required on heating water pumps.

This standard does not apply to design of pumps for use in central plant.

Part 2 – Products

HVAC Pumps

Owner has pre-approved the following manufacturer to be in compliance with these standards: Bell & Gossett.

Part 3 – Execution

All heating hot water and domestic hot water circulating pumps shall be backed-up, and shall have automatic change-over on HHW pumps.

All critical area chilled water pumps for stand-alone chiller systems shall be backed-up, and provided with automatic change-over.

DIVISION 23 – HEATING, VENTILATING, AND AIR-CONDITIONING (HVAC)

Section
Number

All pumps shall be selected for minimum maintenance, such as in-line circulators where appropriate. All coupled pumps shall require laser alignment after installation, and alignment documentation shall be provided to the Owner (Inspector).

All pumps shall have in-line strainers installed upstream of suction.

All pumps shall automatically restart after a power outage.

All HVAC equipment shall be connected to a Hand/Off/Auto starter. Momentary starters shall not be used.

All pump motors located remote from the motor control center shall be designed with a local disconnect that may be locked out.

Housekeeping pads shall be installed for all base mounted pumps. Grout pumps to pads with non-shrink grout prior to alignment and testing.

Ball isolation valves shall be installed so that the pump can be isolated for repair. No butterfly valves shall be used on pipe under 4" in size at suction and discharge of pump.

23 22 00 Steam and Condensate Piping and Pumps

23 22 13 Steam and Condensate Heating Piping

Part 1 – General

N/A

Part 2 – Products

Pipe Requirements

Service	Size	Pipe	Fittings	Joints
Steam	Up to 2"	Sch. 40	Forged carbon	threaded, bevel,
		Seamless, black	steel	weld or welded
				socket
Steam	2 1/2 " and	Sch. 80	Forged carbon	bevel welded
	larger	seamless, black	steel	
		steel		
Condensate	All	Sch. 80	forged carbon	Welded or Threaded

DIVISION 23 – HEATING, VENTILATING, AND AIR-CONDITIONING (HVAC)

Section
Number Title

		Seamless, black		
		steel		

All steel piping for steam and condensate duty shall be domestic.

Brass, copper and bronze fittings and/or valves are not permitted for steam service. Valves 2" and smaller shall be carbon steel, quarter turn ball valves. Valves larger than 2" shall be high performance butterfly, bubble tight shutoff, and bi-directional if the piping can or will be pressurized from two directions.

Pressure Gauges:

- Rated for steam service up to 150 psi.
- Cast aluminum with 4 1/2" dial
- Selected with normal operating range at the midpoint of the scale
- Furnished with pressure snubber and shutoff valve

Strainers:

- 250# cast-iron, 2" - threaded through
- 2 1/2" and larger - Flanged (150 lb.) cast iron
- Size 100 mesh
- Provide isolation valves on each side of strainers and full port ball valve on blow down. Provide hose thread connection on blow down port 3/4" and below.

Steam Traps:

- The use of thermodynamic traps requires written approval from Owner (HVAC Supervisor).
- The use of orifice type traps is prohibited.
- Owner has pre-approved the following manufacturers to be in compliance with these standards:
 - Armstrong bucket or Float & Thermostatic for end of line, drip legs, and main lines as code requires.
 - TLV float & thermostatic for modulating service

Pressure Regulators:

- Globe valves are required in bypass.
- Vented to exterior of building through relief valve
- Owner has pre-approved the following manufacturer to be in compliance with these standards:
 - Fisher, Industrial Type 92B

Expansion Joints:

DIVISION 23 – HEATING, VENTILATING, AND AIR-CONDITIONING (HVAC)

Section
Number

Title

- Externally pressurized bellows type, weld end
- Owner has pre-approved the following manufacturer to be in compliance with these standards:
 - Hyspan 3500

Condensate Pumps:

- Duplex electric pump
- Cast-iron housing

Part 3 – Execution

Provide isolation valves at all equipment and on all main branch take-offs.

Include pressure gauges on both sides of all pressure regulators and at all steam using equipment.

Provide strainers with isolation valves and piped blow down ahead of steam traps and control valves. Provide unions or flanges to allow disassembly of strainer.

All steam and condensate piping shall be designed and detailed to include adequate expansion joints or loops, and such joints or loops shall compensate for expansion of the supply piping that it is connected to.

Design to detail location of atmospheric vent lines and pressure relief vent lines out of doors in a safe location. Include drip pan elbow for all pressure relief vent lines.

Use eccentric reducers to assure level bottom.

Steam and condensate piping pitch downward in direction of flow at 1/2" per 10 ft.

Direct - buried steam and condensate systems are not allowed. All steam and condensate lines to be in accessible location.

23 23 00

Refrigerant Piping

Part 1 – General

This Section includes refrigerant piping used for refrigeration and air-conditioning applications.

Pre-charged line sets are not allowed.

DIVISION 23 – HEATING, VENTILATING, AND AIR-CONDITIONING (HVAC)

Section
Number Title

Part 2 – Products

Pipe Requirements - Above grade

Service	Size	Pipe	Fittings	Joints
Refrigerant Piping	All	Type 'L' ACR 15% Silver Solder Brazed	Wrought Copper Or Cast Brass	15% Silver Solder

Pipe Schedule - below grade

Service	Size	Pipe	Fittings	Joints
Refrigerant Piping Use long radius fittings only	All	Type 'K' ACR 15%	Wrought Copper Or Cast Brass	15% Silver Solder Brazed

Part 3 – Execution

All refrigerant piping shall be designed, sized and detailed to comply with manufacturer's recommendations concerning size, rise, insulation, etc. to ensure that oil migration does not occur.

Refrigeration isolation valves shall be installed at each refrigerant section (i.e. compressor, condenser, and evaporator) so that the charge does not have to be removed for repair and maintenance. Install isolation valves between split system components. Canister style changeable filter driers shall have refrigerant rated ball valves for isolation. Use Schrader valves on suction and liquid line a.

Refrigerant piping systems shall be designed, detailed and specified to be installed with:

- Piping supports to code.
- Line size traps at a minimum of every 25 feet of vertical lift
- Specification to require installation by qualified technicians
- Piping to be installed per ASHRAE standards
- Filter Drier:
 - Line Filter before expansion valves.
 - Suction Line filter before compressor.
 - Canister style used for 50 tons and above.

Nitrogen purge to be provided during soldering.

Owner reserves the right to cut into any two fittings to confirm the use of nitrogen purge.

****END OF SECTION****

DIVISION 23 – HEATING, VENTILATING, AND AIR-CONDITIONING (HVAC)

Section
Number Title

23 30 00 HVAC AIR DISTRIBUTION

23 31 00 HVAC Ducts and Casings

23 31 13 Metal Ducts

Part 1 – General

N/A

Part 2 – Products

Supply, Return, General Exhaust

Galvanized Steel shall be ASTM A 527, G90 of lock forming quality.

Flexible Ductwork

Ductwork to be constructed in accordance with NFPA 90A, 90B, UL181 Class 1

Chemical Fume Exhaust

Fume hood branch duct, manifolded main ducts and any duct subject to concentrated chemical fumes shall be:

- Stainless Steel shall be ASTM A 240, type 316, minimum 22 gauge
- Spiral or welded for fumehood applications.
- Fittings shall be continuously welded – liquid tight.
- Spiral duct, with flanged connections.
- Joints will be constructed with a process equal to the Thermofit Wrap-around Duct Bands manufactured by Raychem.
- Longitudinal, all welded seams shall be specified for perchloric or other highly corrosive applications.
- Balancing valves are required at the take offs from the main trunk line.

Coated Galvanized Steel

Under special circumstances, with Owner permission, coated galvanized steel ducts may be used for manifolded general chemical exhaust plenums which are large enough to allow duct internal inspection and repair of coating. Specification for coating type and thickness shall be reviewed and approved by Owner.

Duct Sealants

Specify use of Hardcast AFG-1 402 Foil-Grip tape, Hardcast DT-Tape with FTA-20 adhesive, or water based paint-on duct sealant for indoor use, or RTA-50 adhesive for outdoor use, to seal all duct joints.

DIVISION 23 – HEATING, VENTILATING, AND AIR-CONDITIONING (HVAC)

Section
Number

Title

Part 3 – Execution

Supply, Return, General Exhaust

Use long radius (center radius of 1.5 times duct width (minimum)) on tees, bends, and elbows.

Ductwork shall be stored in a clean location prior to installation. Openings shall be covered to prevent entry of dust, moisture and general construction dirt/debris. Plastic sheeting securely taped over open ends is acceptable.

Balancing dampers on all branch ducts at the main trunk shall be used and show location on drawings.

Use single thickness turning vanes only in ductwork up to 2" pressure class.

Use airfoil type vanes for higher pressure class. Install per SMACNA.

Turning vanes are not allowed in reducing elbows.

No bellmouth, flanged or notch spin-in connections permitted except at terminal/diffuser take-offs.

No extractors allowed.

Flexible Ductwork

Maximum flexible ductwork lengths - 18" on high pressure systems, 48" on low pressure systems.

High pressure flexible ductwork shall not be used for changes in direction.

Low pressure flexible ductwork may only be used to accommodate a total of a 45° change in direction. Hard elbows shall be used at diffusers.

Flexible ductwork shall be secured utilizing steel draw-band clamp.

Chemical Fume Exhaust

Chemical exhaust ductwork to conform to ANSI/AI HA standard 29.5 – 1992.

Exhaust system designs shall conform to American Industrial Hygiene Association (AIHA) Industrial Ventilation manual.

DIVISION 23 – HEATING, VENTILATING, AND AIR-CONDITIONING (HVAC)

Section
Number

Title

All exhaust ductwork within the building shall be under negative pressure, with the exception of a limited length of pressurized duct from the fan discharge to outside.

Design exhaust ductwork connections to equipment to allow for proper drainage flow.

Fumehood exhaust ductwork can be manifolded only if multiple exhaust fans are used.

Fume hood exhaust systems are to be designed and specified to prevent any inside surface protrusions especially at joint connections that can catch condensation of fume hood vapors. This includes screwed duct connections.

Filters shall be 2" thick, pleated, 300 FPM maximum velocity, mean efficiency of 36% according to ASHRAE 52-68.

23 34 00

HVAC Fans

23 34 16

Centrifugal HVAC Fans

Part 1 – General

Section Includes:

Air Handling fans, blowers and accessories

Selection of all air handling fans and blowers shall consider air density effects of Owner's 7000 ft elevation.

No centrifugal fan or blower is to be operated at greater than 2000 RPM. Specific applications requiring centrifugal fans to operate at greater than 2000 RPM shall be reviewed and approved in writing by Owner (HVAC Supervisor).

Centrifugal fans handling more than 1,000 CFM shall have backward inclined blades.

Variable frequency drives shall not be specified for forward curved fans.

Utility fans serving fume hoods to discharge out top of stack at a minimum velocity of 3000 f.p.m.

All air handling fans and blowers shall be selected and specified to deliver designed airflow and pressure at less than maximum fan RPM of fan pressure class specified.

DIVISION 23 – HEATING, VENTILATING, AND AIR-CONDITIONING (HVAC)

Section
Number

Title

All air handling fans and blowers shall be selected and specified to deliver designed airflow and pressure without vibration and noise problems, and to enable air balancing without fan or blower over-speed.

Bathrooms, shower rooms, laundries, and kitchens shall be designed to be individually power exhausted and not tied into any other building exhaust or ventilating systems. Unless approved by Owner through life cycle analysis, heat recovery shall be specified.

Part 2 – Products

Fans shall be tested in accordance with ANSI/ASHRAE STD 51 and ANSI/AMCA STD 210.

Standard Products – The same manufacturer shall be used for multiple installations for the same type. Owner has pre-approved the following manufacturers to be in compliance with these standards: Greenheck, ILG, Trane.

Fans shall be statically and dynamically balanced at the factory.

Bearings shall be heavy-duty split pillow block, self-aligning ball bearings with seals and grease nipples, minimum service life of 200,000 hrs. Permanently lubricated bearings are not acceptable.

Short coupled, multi-belted fans shall utilize companion sheaves in lieu of variable pitched sheaves.

Minimum size of drain connection in bottom of fan housing is 3/4".

Minimum size of access doors to blower section is 18" x 18".

Fan to duct systems shall be located indoors. Where fans must be located outdoors, specify weather-proof package.

Minimum height of discharge stack for chemical exhaust fan is 10' above adjacent accessible roof.

Control Dampers

Owner has pre-approved the following manufacturer to be in compliance with these standards: Tampco Dampers.

Section
Number

Title

Part 3 – Execution

In-line fans/blowers shall have adequate access panels for service and maintenance.

Grease fittings shall be extended for easy access without the need for equipment shutdown.

Design and detail centrifugal fan installation such that fan shaft and wheel can be removed without disassembly of adjacent equipment.

23 36 00

Air Terminal Units

Part 1 – General

Specification for terminal box test submittal data shall require compliance with ADC/ARI Standard 880-89.

Part 2 – Products

Specify use of only 'long' terminal boxes for any air volume control application requiring accuracy greater than +/- 25%.

Specify Terminal Box controllers to be Direct Digital and compatible with Owner's EMS. DDC controllers shall be factory mounted.

Specify that all Terminal Box controls and actuators shall be externally mounted.

Specify minimum press drop across Terminal Box to be 0.1" wg with control damper fully open.

Specify maximum sound power level to meet HVAC acoustical requirements.
Specify terminal Boxes to have screwed access doors if serviceable items are enclosed.

Box damper leakage shall not exceed 2% of nominal box rating at 4" static pressure.

Part 3 – Execution

Duct systems require a minimum of 18" clearance access for service and maintenance of equipment components. Show service access clearance requirements in graphic form on drawings.

Provide detail of terminal box support system on drawings. Detail to require trapeze hanger where possible. Sheet metal strap hangers screwed to side of terminal box is not allowed.

DIVISION 23 – HEATING, VENTILATING, AND AIR-CONDITIONING (HVAC)

Section
Number

Title

Detail and specify acceptable box entry and exit conditions. Design high velocity ductwork to provide sufficient straight duct and low turbulence to meet manufacturer's requirements. Specify maximum allowable offset in flexible duct connection to inlet of box.

23 38 00
23 38 13

Ventilation Hoods
Commercial-Kitchen Hoods

Hoods and Ventilation Systems

Hood lighting shall be vapor-proof or explosion proof, depending upon the intended purpose of the hood. Light bulbs shall be accessible for changing outside the hood.

Each sink under a hood shall be individually trapped.

Surface Fire Protection System

Surface fire protection systems shall be included in all food service hoods.

****END OF SECTION****

DIVISION 23 – HEATING, VENTILATING, AND AIR-CONDITIONING (HVAC)

Section
Number

Title

23 50 00 **CENTRAL HEATING EQUIPMENT**

23 52 00 **Heating Boilers**

Part 1 – General

N/A

Part 2 – Products

Boilers shall be rated for operation at 7000 ft. elevation. This may require modification of standard factory unit. Boiler/burner shall be stamped for design performance at 7000 ft. elevation.

All boilers to be commercial/industrial quality.

The make and model of boiler shall have been manufactured for continuous commercial service in the continental USA for more than three years.

Parts and service for specified boiler shall be readily available through a distribution system in the continental US.

Boiler manufacturer, make and model require prior written approval by Owner (HVAC department). Submit proposed manufacturers for written approval before finalizing specifications.

Part 3 – Execution

All stand-alone boiler installations shall have a three-foot clear working area around all sides of the boiler, including the top.

All safeties shall be non-lockout, unless codes require otherwise.

23 57 00 **Heat Exchangers for HVAC**

Part 1 – General

Heat exchangers are to be located no more that 5' above finish floor. Heat exchangers are not to be mounted to ceiling.

In Design Development drawings, demonstrate adequacy of mechanical room geometry for purpose of heat exchanger service clearance for removal and replacement.

DIVISION 23 – HEATING, VENTILATING, AND AIR-CONDITIONING (HVAC)

Section
Number

Title

Isolation valves and unions are required on all heat transfer units on both sides of heat exchanger, both sides of pumps, at strainers and air separators. All Isolation valves shall be ball valves.

All glycol to be propylene glycol with inhibitors. Owner uses Dowfrost in the glycol system.

Design outside air preheat loops with 40/60 glycol mixture for freeze protection, use closed loop with no City of Flagstaff make-up water connection. There shall be a mixing tank and pressurization pump for this application.

For applications with extensive outdoor glycol piping, provide 50/50 mix for freeze protection.

Glycol recovery tank shall allow complete system drain back.

Part 2 – Products

Factory assembled heat transfer skids, including heat exchangers, pumps, air separator, piping and controls is acceptable upon written approval by Owner (HVAC Supervisor), provided a minimum of 36" outboard of skid is provided and maintenance access to all components is provided. A complete manufacturer dimensional shop drawings showing all components and service access, including tube bundle pull space to be shown graphically.

Heating Water Exchangers: Field erected heat transfer systems are required. Design drawings to provide sufficient detail to show all components and minimum service access clearances. Service access, including tube bundle pull space to be shown graphically. Contractor shall submit complete shop drawings including dimension plan, elevation and isometric for Owner to review and approve prior to construction.

Tube bundle in tank heat exchangers are required. Heat exchangers shall be stainless steel or cupro-nickel alloy.

Part 3 – Execution

All heat exchangers used for space heating purposes shall have controls that fail closed.

****END OF SECTION****

DIVISION 23 – HEATING, VENTILATING, AND AIR-CONDITIONING (HVAC)

Section
Number

23 60 00 **CENTRAL COOLING EQUIPMENT**

23 62 00 **Packaged Compressor and Condensate Units**

Part 1 – General

Direct evaporative cooling, whether alone or in addition to a mechanical or indirect evaporative system, shall not be used.

For wet wall installations, face and bypass dampers must be used for temperature control. Wet wall pump cycling shall not be an option for temperature control. Bypass dampers shall be sized to allow full air flow around the wet wall.

Part 2 – Products

Specify only commercial or institutional grade refrigeration equipment.

Equipment to operate with refrigerant 410A unless otherwise approved in writing by Owner.

Crank case heaters shall be installed on all compressors.

Service valves are required on anything over 5 tons.

Specify low ambient controls for equipment that operates year around. Specify head pressure or equivalent control. Variable speed for primary condenser fan is required.

Provide hail guards on outdoor condensers.

Part 3 – Execution

Provide 3 feet clearance around rooftop units or remote condensing units.

23 64 00 **Packaged Water Chillers**

23 64 23 Scroll Water Chillers

Part 1 – General

Design and specify air and water-cooled scroll chillers up to 100 tons.

Part 2 – Products

Specify only commercial or industrial grade equipment.

Owner has pre-approved the following manufacturers to be in compliance with these standards: Trane, Carrier, York, McQuay.

DIVISION 23 – HEATING, VENTILATING, AND AIR-CONDITIONING (HVAC)

Section
Number

Title

Unit Description

Liquid chillers can be semi hermetic or scroll compression design. Separate refrigerant circuits shall include the following: liquid line solenoid valve, filter dryer, sight glass, thermostatic expansion valve and service valves.

Unit efficiency shall meet ASHRAE 90.1

Evaporator

Exterior units shall have a glycol mixture, be fully insulated, and equipped with a drain connection.

Air Cooled Condensers

Provide head pressure control.

Electrical

Include motor starters with equipment.

Controls

All equipment shall be complete with leaving water control and unloading capability, low/high pressure switches, low ambient, freeze stat, flow switch and motor overload safeties, low oil pressure safety switches.

Receivers

Shall be capable of entire refrigerant charge pumpdown.

Head Pressure / Load Control

Shall be capable of running in low load and low ambient conditions. Provide compressor cylinder for any semi-hermetic system. Provide variable speed condenser fan. Provide hail guard on air cooled condenser.

Refrigerant

Refrigerant shall be of R-410A.

Part 3 – Execution

Remote Interface - provide interface with building/campus energy management system for alarms, start/stop, status, water temperatures.

All systems are to be dehydrated, leak tested charged and tested for proper control and operation.

DIVISION 23 – HEATING, VENTILATING, AND AIR-CONDITIONING (HVAC)

Section
Number

Title

23 65 00

Cooling Towers

Part 1 – General

Towers used for water-cooled condensing or for indirect evaporative cooling shall be designed and specified to be protected from freeze damage. Whenever condenser water is pumped through a coil located in a tower, redundant pumping with automatic start of the alternate pump is required. These systems shall be remotely alarmed upon loss of flow through the coil.

Sumps shall drain to storage rather than to waste for freeze protection.

Part 2 – Products

Cold water basin shall be stainless steel.

Owner has pre-approved the following manufacturers to be in compliance with these standards: Marley, Evapco, Baltimore Aircoil

Part 3 – Execution

Systems shall be equipped with chemical feed systems as coordinated by the Owner's chemical treatment consultant. Tower sump and evaporative cooling sumps shall have total dissolved solids (TDS) controlled blowdown; continuous blowdown is not acceptable.

****END OF SECTION****

DIVISION 23 – HEATING, VENTILATING, AND AIR-CONDITIONING (HVAC)

Section
Number

Title

23 70 00 **CENTRAL HVAC EQUIPMENT**

23 73 00 **Indoor Central-Station Air-Handling Units**

23 73 13 Modular Indoor Central-Station Air-Handling Units

Part 1 – General

Owner’s baseline system design is a Single Duct VAV Concept. Energy Models with total cost of ownership calculations are required when proposing other systems.

AHU to be 'draw-thru' type. Fan walls with backdraft dampers with a minimum of 4 fans are preferred.

Fan Coil Units

Size AHU to meet latest edition of ASHRAE Standard 62.

Consider location of Outside Air (OA) intakes in concept design. Preferred location is above roof level - not ground level. However, avoid location of AHU outside air intake in vicinity of exhaust louvers, plumbing vent stacks, emergency generator stacks, loading dock areas, smoking area. Consider potential for drift snow and fly snow in sizing and placing outside air intakes.

Design physical layout of AHU in building mechanical rooms to provide service access. AHUs are to be located no more that 5’ above finished floor. AHUs are not to be mounted to ceiling.

OA intakes to be hard ducted through mechanical rooms.

Access is required to both sides of AHU fans to allow for bearing replacement.

Design to ensure smooth, uniform inlet and discharge flow conditions to and from AHU to avoid significant static pressure penalty of system effect.

Air handler manufactured to provide a 'minimum' of one fan impeller diameter upstream of the fan.

Fan wall air handlers shall be manufactured so that motor can be removed with the fan blade attached.

Provide vibration safety switches on all vaneaxial type fans.

When vaneaxial fans are used, ensure suitable access is provided for

DIVISION 23 – HEATING, VENTILATING, AND AIR-CONDITIONING (HVAC)

Section
Number

Title

servicing/removal.

Control valves shall be located outside of air handler enclosure.

All chilled water coils and direct expansion (DX) coils located in fan coil unit above the ceiling shall have a secondary drain pan under the fan coil unit. The secondary drain pan shall drain to a custodian sink. Such piping shall be directly connected to the secondary drain pan and maintain a minimum horizontal slope in the direction of discharge of not less than one-eighth unit vertical in 12 units horizontal (1-percent slope).

Part 2 – Products

Air handlers to be institutional grade.

Minimum air handler specification shall include the following:

- Heating coil shall be upstream of the cooling coil.
- Double walled casing - minimum 18 gauge. AHU shall not be constructed using porous or semi porous materials.
- Hinged access doors to both sides of coils, fans, filters and damper sections.
- Large (Above 10,000 CFM) AHU to have inspection windows in access doors.
- AHU shall have interior inspection lights.
- Side access doors for slide in/slide out filter tanks. All filters shall be specified as 24x24x2 to 24x24x12.
- Removable side panels in fan sections to allow for fan and shaft removal/replacement.
- Utilize only “premium efficiency” motors in AHU's. All motors shall be inverter rated.

Owner has pre-approved the following manufacturers to be in compliance with these standards: Energy Labs, Hunt Air.

Fan Coil Units

Owner has pre-approved the following manufacturers to be in compliance with these standards: Carrier, Trane, or McQuay.

Part 3 – Execution

All air handling units with outside air shall be equipped with freeze stats with manual reset located between the heating and cooling coil, outside air dampers and low-limit controls. All heating hot water valves shall fail to heating position. All outside air dampers shall fail closed.

DIVISION 23 – HEATING, VENTILATING, AND AIR-CONDITIONING (HVAC)

Section
Number

Title

All heating coils that may be exposed to outside air shall be protected by a low limit temperature control, located downstream of the heat or preheat coil, which will open the supply valve upon failure to maintain the minimum temperature set point. Further, any fan or blower that moves air across such a coil shall shut down upon failure to maintain a minimum temperature, which should have a lower set point than the supply coil low limit. Outside air dampers shall be closed and a hot water valve shall be opened.

Ensure coil drain pans and condensate pipework is pitched to drain, (minimum pitch 1/4" per foot). Provide a secondary drain pan outside of the air handler unit and fan coil unit and provide piping from secondary pan to visible building drain like a custodial closet.

In new construction, utilize AHU to 'flush' building to reduce off-gassing of interior furnishings prior to occupancy. Fit AHU with temporary filters of same quality as permanent filters during this period.

Replace filters before system balancing.

23 74 00 Packaged Outdoor HVAC Equipment

23 74 13 Packaged, Outdoor, Central-Station Air-Handling Units

Part 1 – General

Outdoor air handlers are not allowed.

Part 2 – Products

N/A

Part 3 – Execution

N/A

****END OF SECTION****

DIVISION 23 – HEATING, VENTILATING, AND AIR-CONDITIONING (HVAC)

Section Number	Title
23 80 00	DECENTRALIZED HVAC EQUIPMENT
23 81 00	Decentralized Unitary HVAC Equipment
23 81 26	Split System Air Conditioners

Part 1 – General

Refrigerant air conditioning systems shall be utilized **only** when specifically authorized by Owner in writing. Life cycle cost analysis shall be utilized to determine the most appropriate type.

Summertime cooling systems shall have economizer cycles with 100% outside air capability. Enthalpy controls shall be provided on all systems that run continuously. Indirect evaporative cooling shall be considered as an additional capacity system.

When A/C systems are proposed to run year round for critical areas, refrigerant receivers and suction line accumulators shall be used. All critical area A/C systems shall be redundant or a parts inventory shall be included in close-out submittal requirements to cover emergency repairs. This inventory shall include any and all controls motors or equipment required to make the system operational in an emergency.

Crank case heaters shall be installed on all compressors.

All outdoor compressor units shall be located under permanent covers.

Provide all necessary valves and equipment to permit refrigerant recovery/recycle.

All air-cooled condensers shall have low ambient temperature controls, and head pressure sensing or equivalent controls. Variable speed for the primary condenser fan is preferred.

Part 2 – Products

N/A

Part 3 – Execution

N/A

23 82 00	Convection Heating and Cooling Units
23 82 16	Air Coils

DIVISION 23 – HEATING, VENTILATING, AND AIR-CONDITIONING (HVAC)

Section
Number

Title

Part 1 – General

Coil Section

Consider high dewpoint outside conditions when sizing cooling coils.

Select cooling coils with water temperatures of 42/62°F EWT/62°F LWT (summer) and 48/60°F EWT/62°F LWT (winter).

Select heating coils with a 40°F water temperature differential.

Maximum coil face velocity 400 fpm.

Maximum coil pressure drop 0.5" SP.

All heating coils that may be exposed to outside air shall be protected by a low temperature control, located downstream of the coil, which will open the supply valve upon failure to maintain the minimum temperature set point. Further, any fan or blower that moves air across such a coil shall shut down upon failure to maintain a minimum temperature, which should have a lower set point than the supply coil low limit. Outside air dampers shall fail closed and a hot water valve shall fail open.

Part 2 – Products

Chilled water coils shall be counter flow with a minimum of 7 rows.

Part 3 – Execution

Provide maintenance access to all equipment requiring service.

23 83 00 Radiant Heating Units

23 83 13 Radiant-Heating Electrical Cables

Part 1 – General

Electric heating cables shall not be used; this application requires hydronic heating.

Part 2 – Products

N/A

Part 3 – Execution

N/A

DIVISION 23 – HEATING, VENTILATING, AND AIR-CONDITIONING (HVAC)

Section Number	Title
23 83 16	Radiant-Heating Hydronic Piping Polyethelene (PEX) or approved equal piping. High pressure radiant units.

****END OF SECTION****

Section Number	Title
26 00 00	ELECTRICAL
26 05 00	Common Work Results for Electrical
26 05 13	Medium Voltage Cables
26 05 19	Low Voltage Electrical Power Conductors and Cables
26 05 26	Grounding and Bonding for Electrical Systems
26 05 29	Hangers and Supports for Electrical Systems
26 05 33	Raceway and Boxes for Electrical Systems
26 05 36	Cable Trays for Electrical Systems
26 05 43	Underground Ducts and Raceways for Electrical Systems
26 05 53	Identification for Electrical Systems
26 09 00	Instrumentation and Control for Electrical Systems
26 09 13	Electrical Power Monitoring and Control
26 09 43	Network Lighting Controls
26 10 00	MEDIUM VOLTAGE ELECTRICAL DISTRIBUTION
26 20 00	LOW VOLTAGE ELECTRICAL TRANSMISSION
26 22 00	Low Voltage Transformers
26 24 00	Switchboards and Panels
26 24 13	Switchboards
26 24 16	Panelboards
26 25 00	Enclosed Bus Assemblies
26 27 00	Low Voltage Distribution Equipment
26 27 26	Wiring Devices
26 29 00	Low Voltage Controllers
26 29 13	Enclosed Controllers
26 29 23	Variable Frequency Motor Controllers
26 30 00	FACILITY ELECTRICAL POWER GENERATING AND STORING EQUIPMENT
26 32 00	Packaged Generator Assemblies
26 32 13	Engine Generators
26 36 00	Transfer Switches
26 40 00	ELECTRICAL AND CATHODIC PROTECTION
26 41 00	Facility Lightning Protection
26 41 13	Lightning Protection for Structures
26 43 00	Transient Voltage Suppression
26 43 13	Transient Voltage Suppression for Low-Voltage Electrical Power Circuits
26 50 00	LIGHTING
26 51 00	Interior Lighting
26 56 00	Exterior Lighting

Section Number	Title
26 00 00	ELECTRICAL

Part 1 - General

Electrical Load Monitoring: Investigate the existing electrical service/distribution system and determine if sufficient capacity is available to accommodate the new loads. Meter readings are required per NEC.

Existing Electrical Installation: Investigate all existing electrical installations such as existing concealed conduit runs, conduit types/sizes, cable types/sizes, panelboard types/sizes, electrical equipment locations, etc., which potentially impact the new installation.

Calculations

The Design Professional shall submit the following calculations to NAU during the design process in the Basis of Design:

- Lighting calculations
- Size of each conductor
- Size of each overcurrent protective device
- Size of each equipment bus
- Size of each transformer
- Size of each generator and transfer switch
- Setting of each overcurrent protective device with adjustable characteristics
- Required PPE to meet arc flash incident energy levels
- Fault current calculations
- Protective device coordination study
- Arc flash calculations (when not required to be performed by the Contractor)
- Load calculations
- Generator and/or UPS sizing calculations
- Voltage drop calculations
- Harmonic distortion calculations
- Lightning protection system risk analysis

Fault Current Calculations: Prepare and submit calculations for all new projects and renovations to existing electrical distribution systems. The available fault currents shall be included on the riser diagrams, and shall show the available fault current (expressed in amperes, RMS symmetrical) at each overcurrent protective device and transformer in the system. Supporting calculations (such as those resulting from a SKM PowerTools™ analysis) that justify the summary available fault currents on the riser diagrams.

Section Number	Title
	<p>Coordination Study: Prepare coordination curves to determine the required settings of overcurrent protective devices with adjustable trip characteristics. The Design Professional shall verify field settings at time of project completion.</p>
	<p>Arc Flash Calculations: Perform, or specify, an arc flash analysis in accordance with Institute of Electrical and Electronics Engineers (IEEE) Std 1584a. For each bus analyzed, determine the following: Flash Hazard Protection Boundary, Incident Energy Level, Required Personal Protective Equipment Category, Type of Fire Rated Clothing, Limited Approach Boundary, Restricted Approach Boundary, and Prohibited Approach Boundary. Present, or specify to be submitted, the data determined by the analysis in a tabular format, and submit, or specify to be submitted, the preparation of arc flash warning labels for each piece of electrical equipment, showing the items listed above as well as the date of issue.</p>
	<p>Load Calculations: Prepare and submit load calculations that justify the size of each branch circuit and feeder, overcurrent protective device, transformer, and equipment bus (panelboard, switchboard, switchgear, automatic transfer switch, etc.). Calculations shall be performed at all voltage levels. The method of calculation, including all applicable NEC diversity factors and non-coincident loads and their employment at various levels of the electrical system, as well as capacity reserved for future load, shall be clearly presented in the drawings. Calculations may be in panel schedule and switchboard schedule format. It shall be possible for the NAU reviewer to follow the load flow from the lowest level to the highest level of the riser diagrams.</p>
	<p>Generator Sizing Calculations: Prepare and submit calculations that justify the size of each generator, including all loads downstream of the generator set(s) and the sizing impacts of proposed load steps, significant motor loads, non-linear loads, and capacity reserved for future loads.</p>
	<p>Voltage Drop Calculations: Prepare and submit calculations demonstrating compliance with the following voltage drop limits: 2% for feeders, and 3% for branch circuits, taken at design load.</p>
	<p>Harmonic Analysis: Prepare and submit calculations estimating the voltage and current total harmonic distortion (THD) for buses rich in non-linear loads. Use these calculations to justify active or passive components to mitigate harmonic distortion.</p>
	<p>Lighting Calculations: Lighting calculations shall include the room name, room number, fixture type chosen for the room, number and type of lamps to be used in the room, required illumination level, calculated illumination level, and light loss and reflectance assumptions used. Calculations for most interior spaces may be performed using the zonal cavity method. Perform and submit point-by-point</p>

Section Title
Number

footcandle-level calculations for areas of greater architectural or luminous sophistication, and outdoor areas. The Design Professional shall submit exterior outdoor point-by-point footcandle-level calculations and accompanying luminaire cutsheets to the Dark Sky Committee for review. Calculations shall include demonstrated compliance with energy conservation measures and codes.

Design Requirements

The DP must discuss the concept of a roof-mounted photovoltaic (PV) system with Owner on a per-project basis. It is Owner's desire to have PV on roofs, where feasible. Provide conduit path(s) from the roof to the electrical service entrance equipment to facilitate connection of roof-mounted photovoltaic systems. Building electrical service equipment shall have breaker space to accept connection of grid-tied photovoltaic systems.

All materials shall be new and previously uninstalled, listed and approved by Underwriters Laboratories.

Electrical equipment spaces shall not be located beneath toilets, showers, laboratories, kitchens, sinks, open courtyards, planters, roof drain leaders, or other areas where water service is provided. Electrical equipment spaces shall be designed to allow maintenance equipment access, and to facilitate equipment replacement without demolition and reconstruction other than removal of a door centerpost.

The Design Professional shall show electrical equipment footprints and accompanying National Electrical Code (NEC) working clearances on the drawings. Provide the same working clearance for non-fused switches as is required for fused switches.

Any wet pipe foreign to the electrical installation shall not enter or pass through an electrical equipment space. The Design Professional shall ensure that foreign piping such as water pipes, steam pipes, medical gas pipes, sanitary waste pipes, roof drains, A/C ducts and other unrelated piping systems containing liquids or gases are not installed or pass through electrical equipment spaces. Sprinkler piping shall not be routed through electrical rooms, unless it serves to protect the electrical installation.

Electrical equipment spaces shall have the necessary mechanical ventilation or cooling system to maintain the indoor temperature range required for proper operation of the equipment within its UL listing.

Electrical equipment spaces that contain freestanding electrical equipment shall be sized such that sufficient space is provided to add one additional section to each unit

Section
Number

Title

of freestanding equipment. Provide extended pad space and spare conduits that will facilitate future installation of equipment and conductors. Spare space shall be indicated on drawings.

Electrical closets shall have 20% spare wall space for future installation of similar electrical equipment.

Installation Requirements

All electrical equipment, disconnects, starters, panels, devices and plates shall be installed plumb and true.

All electrical work shall be inspected and approved by Owner (Electrical Department or its designee) before being covered. All tests are to be observed by the Owner (Electrical Department or its designee).

Switchboards, panelboards, transformers, transfer switches, gutters, junction boxes and other electrical equipment with doors or removable covers shall not be painted other than with original factory paint and necessary touch-up paint.

Submittals

Provide complete submittals of all electrical and electronic equipment. Diagrams shall show installed component model numbers; block diagrams do not constitute an acceptable schematic. There shall be a separate submittal for each of the first-4 digits of the CSI divisions, as needed. For example, a separate submittal is needed for Division 26 05 as opposed to a submittal for Division 26.

Licenses

The electrical contractor shall furnish copies of State of Arizona high voltage license to Owner before proceeding with any work over 600 volts, including but not limited to conduits and ductbanks for medium voltage cables, switchgear, transformers, cabling, splices, or terminations.

As-built Documents

Contractor shall thoroughly mark the construction drawings to show as-installed circuiting, locations of major electrical components, panel schedules, and locations of major underground conduit and ductbank runs dimensioned from fixed surface features. As-builts shall be provided to DP to prepare record drawings.

Electrical Systems Software

All software installed as part of an electrical system shall be licensed to Owner. Owner will direct the Contractor as to the details of software licensing, update notifications, and locations where the software is to be installed.

26 05 00 Common Work Results for Electrical

Section Title
Number

Specific requirements for individual HVAC, Communications, FLS, or other components may be indicated in different divisions. It is the contractors responsibility to follow the requirements outlined in those divisions for conduits and wiring.

26 05 13 Medium Voltage Cables

Refer to Division 33 for all components above 600 volts.

26 05 19 Low Voltage Electrical Power Conductors and Cables

Part 1 – General

Grounded (neutral) conductors shall be minimum #10 AWG.Refer to Division 27 for all low voltage communication wires (Ethernet).

Part 2 – Products

All wire shall be 600V soft-drawn annealed copper, of the type specified herein, and shall be brought to the job in unbroken packages showing the date of manufacture. Manufacture date to be within the past year.

Wire shall be type THHN (THWN in damp locations).

Minimum wire size for power and lighting wiring is #12 AWG, except for controls wiring. Minimum wire size for exterior lighting shall be #10 AWG. Wire of size #10 AWG and larger shall be stranded. All motor-related power and control wiring shall be stranded, regardless of size.

Type MC Cable shall be used only for light fixtures not rigidly supported.

Integral-color insulation shall be used with all wires, regardless of size.

Color code all wire throughout as follows:

PHASE	120/208 VOLTS	277/480 VOLTS
A	BLACK	BROWN
B	RED	ORANGE
C	BLUE	YELLOW
NEUTRAL	WHITE	GRAY
GROUND	GREEN	GREEN
ISOLATED GROUND	GREEN/ORANGE STRIPE	GREEN/ORANGE STRIPE

Wiring for switches shall be the same color as phase wire.

Prewired fixture whips, maximum six feet long, are acceptable when approved by the Design Professional.

Section Number Title
 Splices in wire #8 AWG and larger shall be made with compression-type connectors only. Twist-on connectors shall be used for wire #10 AWG and smaller.

Thermoplastic electrical insulating tape shall be 7 mil flame retardant and weather resistant, resistant to hot and cold weather, applies well at 0 degrees F, has an operating range up to 220 degrees F, and meets the requirements of ASTM D-3005-72 Type 1, UL 510, HHI-595C, and CAS Bulletin No. 561A (105 degrees C.).

Approved wire lubricants shall be used for pulling. Lubricants shall not have a deleterious effect on wire or cable insulation, or on cable labeling.

Part 3 – Execution

All electrical power shall be installed in conduit.

Splices shall not be made in conduits or condulets.

No more than six circuits shall be in a single conduit, subject to NEC deration requirements.

Do **NOT** combine homeruns where shown separately on the drawings.

Mechanical splices shall be covered with a layer of rubber tape, then a layer of thermoplastic tape. When using twist-on wire connectors, wires shall be twisted together with pliers before applying connector.

Carefully train all wire in electrical enclosures in a neat arrangement. Leave wire loops not less than 6" long in each outlet box, even if wires do not stop in the box.

26 05 26 Grounding and Bonding for Electrical Systems

Part 1 – General

All conduit and raceway systems that contain power and lighting conductors shall contain a ground wire, sized per NEC.

The non-current-carrying metal parts of all outlet boxes, pull and junction boxes, gutters, motor controllers, switchboards and switchgear, transformers, panelboards, and any other electrical enclosure shall be bonded to an equipment grounding conductor by a properly-sized bonding jumper.

Separately derived systems shall have the secondary neutral grounded to building steel with an exothermic weld at the fist downstream disconnecting device.

Part 2 – Products

Section Title
Number

N/A

Part 3 – Execution

N/A

26 05 29 Hangers and Supports for Electrical Systems

Part 1 – General

16.5 gauge tie wire and ironworkers tie may only be used for securing horizontal conduit runs within stud walls.

Perforated strap iron or plumbers tape, drive-it anchors, plastic sleeve anchors, lead anchor, or power-driven anchors shall NOT be used for hanging conduit or boxes.

Single suspended conduits shall be on rings with rod hangers with self-drilling anchors or other approved methods. Runs of more than one suspended conduit shall be clamped to a strut trapeze with 300 lb. nut & bolt clamps. All- thread must be backed on both sides with washers, lock-washers and nuts (floating strut or hangers are not acceptable). Trapeze supports shall be 1-5/8" x 1-5/8" channel supported by minimum 3/8" rods.

Part 2 – Products

N/A

Part 3 – Execution

N/A

26 05 33 Raceway and Boxes for Electrical Systems

Part 1 – General

N/A

Part 2 – Products

Conduit

Minimum size of conduit is 3/4", except that 1/2" may be used for dead-end runs in walls, and for fire alarm system wiring.

All fittings for all metallic conduit types shall be steel. All bushings and connectors shall be insulated throat type.

Section Number	Title
----------------	-------

Rigid Galvanized Steel Conduit (RGS) or Intermediate Metal Conduit (IMC) fittings shall be threaded; running threads are not permitted. Union fittings may be used as necessary. RGS threadless connectors or couplings, split couplings that bolt together, self-threading fittings, or couplings permanently attached to conduit shall NOT be used.

Electrical Metal Tubing (EMT) fittings may be compression or setscrew type.

Rigid Non-Metallic Conduit (PVC) shall be Schedule 40 minimum.

Surface-mounted wire raceway shall be installed with manufacturer's accessory fittings. Field-made fittings are not allowed.

All conduits shall terminate with a box except communications, data, phone, etc. lines may terminate with metallic insulated throat threaded bushings at TTB or cable tray. Fasten conduit to cable trays. Owner has pre-approved the following manufacturer to be in compliance with these standards: GEDNEY CTC.

The following materials are prohibited: Aluminum flex flexible metal tubing, electrical non-metallic tubing (ENT), liquid-tight nonmetallic flexible conduit (LFNC), offset connectors, conduit bodies larger than 1-1/4", and SLB fittings.

Boxes

Boxes shall be galvanized steel, minimum 4" square. Use a plaster ring with boxes for receptacles, switches, telecommunications outlets, and fire alarm devices. Use of more than one extension ring is not acceptable.

FS/FD boxes with cast lugs and FS/FD covers shall be used where exposed to moisture or subject to mechanical damage.

Use masonry boxes of the proper depth in unplastered masonry walls. The face of all boxes shall be vertical and not more than 1/4" in from the finished surface. The mason and electrical contractor shall be mutually responsible for the proper execution of masonry work.

Ceiling outlet boxes shall be equipped with 3" round plaster rings. Provide fixture studs if fixture is to be mounted directly on box.

Handy boxes or handy box extension rings are prohibited.

All surface-mounted fire alarm pull station devices shall be mounted on red boxes specifically made for this purpose.

Section
Number

Title

Pendant outlet boxes

Owner has pre-approved the following manufacturers to be in compliance with these standards: Daniel Woodhead 3000 series with cord strain relief. Plates shall match box and outlet used.

Part 3 – Execution

Conduit

Metal conduit shall be used above grade.

Rigid Galvanized Steel Conduit (RGS) or Intermediate Metal Conduit (IMC) shall be used where exposed to weather or subject to mechanical damage, in tunnels, to house medium-voltage conductors in all above-ground locations, and in mechanical rooms below 10' above finished floor.

Flexible steel conduit shall be used only for connection to equipment which is moveable for adjustment, mounted on vibration isolation bases, or for connection to lay-in light fixtures in an accessible ceiling. Maximum length shall be six feet. Aluminum flex is prohibited.

Conduit shall be installed concealed except as noted on plans, or in equipment rooms and tunnels.

All feeder conduits for panels, switchgear, gutters, and pullboxes shall be terminated with grounding bushings bonded to the equipment grounding conductor.

Different electrical systems shall be run in separate, independent raceway systems. Examples of different systems are as follows: 120/208Vs, 277/480V, fire alarm, emergency electrical system, telephone and data, intrusion detection system, and building automation system.

Conduit bend radius shall be per NEC. Ninety degree bends in conduit 1-1/2" and larger shall be made with manufactured elbows or by hydraulic bender.

No more than three 90 degree bends (270 degrees) shall be used between pull, or junction, boxes on data, communications or phone conduits.

Change from one conduit type to another shall be at a box or enclosure.

Sleeves are required for floor penetrations. Sleeves shall extend a minimum of 1" above finished floor. Firestop penetrations through rated walls and floors per requirements of other Sections.

Section Title
Number

Conduits shall be installed such that no wrench or tool teeth marks are evident. Conduit ends shall be cut square, reamed to full size, shouldered in fittings, and fully seated in connector and couplings. Roller type tubing cutters shall not be used.

Conduit installation shall be such that conduits are not abraded, scraped, flattened, dented or wrinkled and the interior diameter is not effectively reduced. Install conduit in such a way that condensation or water cannot be trapped.

Above flush-mounted panelboards, extend spare conduits to above suspended ceilings. For hard (non-accessible) ceilings, spare conduits shall extend to an accessible location and terminate in a labeled junction box with suitable blank cover. A minimum of (1) 1" spare conduit shall be provided for each 3 (or fraction thereof) one-pole spares/spaces, with minimum 3 spare conduits provided.

Surface-mounted conduit shall be painted to match the surface. Conduits concealed or installed in tunnels or equipment rooms shall not be painted.

Exposed conduits shall be grouped in neat parallel lines, properly supported, following the lines of the building structure as closely as possible.

Provide moisture-tight hubs for conduit entries to top or sides of exterior boxes, gutters, panelboards, switchboards, and other electrical enclosures.

All empty or spare conduits for all systems shall have a pull string installed, and be labeled at each as to the location of the other end. When spare conduits stub up from a floor slab, they shall extend 6" above finished floor.

Metallic conduit shall not touch any plumbing pipe, or pipe of other systems. Where contact between dissimilar systems is unavoidable, approved insulation shall be used between the piping systems.

Where telecommunications conduits terminate at a cable tray, a threaded bushing and connector shall be used. Owner has pre-approved the following product to be in compliance with these standards O-Z/Gedney CTC clamp. It shall be used to clamp conduit to cable tray.

Any conduit run that does not allow conductors to be pulled readily will be condemned and replaced with conduit whose workmanship is satisfactory to the Owner (Electrical Department).

Section Title
Number

All fire alarm system conduit shall be inspected and approved by Owner (Fire and Life Safety department) prior to covering the work. Inspection request shall be in accordance with Division 01.

Refer to Section 26 05 53, IDENTIFICATION OF ELECTRICAL SYSTEMS, for mandatory identification of fire alarm system conduits.

HVAC control conduit shall follow this division, except that control wiring may be run through without conduits above ceilings if plenum rated cable is used. Additionally, within mechanical rooms EMT may be used for HVAC communication and control wiring instead of rigid as stated above.

Refer to Division 27 for communications conduit and raceway requirements.

Boxes

All boxes shall be grounded to the conduit system, and bonded to the equipment grounding conductor with a ground screw in the box.

Boxes shall not be installed back to back, even if associated with different systems.

Conduit runs shall not exceed 90 feet between boxes.

Bar hangers shall be used to support boxes in accessible ceilings.

Telecommunications outlet boxes shall be located at heights to match adjoining receptacles, unless otherwise noted.

In renovation work, box mounting heights shall match heights of nearby existing boxes, unless existing heights violate ADA requirements.

Do not compromise integrity of FD/FS boxes by drilling fastening holes in boxes.

In non-combustible walls or ceilings, boxes shall not be set back more than 1/4". In combustible walls, boxes shall be flush with the finished surface. There shall be no broken surfaces, gaps or open spaces at the edge of boxes.

Conduit shall enter boxes at right angles without binding. Offsets shall be used as necessary for proper fit.

When boxes are installed in acoustic walls, the Design Professional shall verify the required STC rating with Owner.

26 05 36 Cable Trays for Electrical Systems

Section Title
Number

Part 1 – General

All buildings except dormitories shall have cable tray for telecommunications wiring. Cable trays shall terminate in designated communication rooms. There must be adequate tray from the communications room(s) to the tunnel entry to the building, and adequate raceway from floor to floor.

Part 2 – Products

All cable trays are to be continuously grounded.

Support for cable tray shall be every 5 feet and within 1-1/2 feet of terminations or changes of direction.

Part 3 – Execution

N/A

26 05 43 Underground Ducts and Raceways for Electrical Systems

Part 1 – General

N/A

Part 2 – Products

Underground pullboxes and lids for 120VAC to 480VAC systems shall be polymer concrete.

Part 3 – Execution

Rigid Galvanized Steel Conduit (RGS) shall be half-lap wrapped with Scotch Wrap #50 or approved equal when installed in concrete or in earth.

Non-Metallic Conduit (PVC) bends of 45 degrees or greater shall be taped RGS. EMT shall not be used underground.

Rigid Non-Metallic Conduit (PVC) shall be Schedule 40 minimum and may be used subject to all the following conditions: Bends of 45 degrees or more shall be made with RGS elbows; PVC may only be used in concrete duct bank or direct buried underground; and PVC shall convert to RGS before stubbing out of earth or concrete with a minimum of 18" of RGS in the slab or earth. RGS shall extend 3' beyond the building when penetrating exterior walls of footings.

Minimum burial depth shall be 18" for conduits containing wiring 600 volts or less, and 36" for conduits containing cables over 600 volts.

Electrical conduits, telecommunications conduits, water piping, and sanitary sewer piping shall be separated by 12" minimum.

Section Title
Number

Underground PVC conduit containing cables under 600 volts shall be surrounded with 6 inches of cinder sand shading all areas.

Underground PVC conduit containing cables over 600 volts shall be encased with a 3000psi minimum of 3" of integral-color red concrete slurry (one 50lb bag of dye per cubic yard of concrete) on all sides of each conduit. Concrete shall be with aggregate small enough to work around conduits. Concrete around duct banks shall be carefully vibrated to prevent voids around and under conduits.

For two or more conduits, use approved plastic base and intermediate spacers beginning no more than 18" from termination at manhole or building wall, and maximum every 5' thereafter. Stake and tie conduits down securely before concrete pour to prevent float.

3" wide locatable marking tape (with appropriate legend, e.g. ELECTRICAL, TELECOMMUNICATIONS) and a #12 stranded tracer wire shall be placed above all buried conduits and duct banks at 12" below finished grade. If duct bank is more than two conduits wide, use two marking tapes, one at each edge of the trench.

Underground pullboxes shall be installed minimum 6' behind back of curb or sidewalk.

26 05 53 Identification for Electrical Systems

Part 1 – General

Arc flash labeling is required.

Part 2 – Products

Provide plastic laminate labels (black with white letters for normal power; red with white letters for generator-backed power) switchgear, switchboards, main and feeder breakers in switchboards and switchgear, panelboards, motor controllers, variable frequency drives, disconnect switches, etc. Mount with self-tapping screws; adhesive type is not approved. Panelboard doors shall be labeled with panel designation and voltage. Lettering to be minimum 3/8" high with inscription centered on label. For switchboards and switchgear with spare breakers or spaces the labels shall be left blank for future engraving by others. In addition, CT cabinets shall be marked with the CT ratio.

Part 3 – Execution

Pullboxes and junction boxes shall be identified with permanent marker as to which circuit(s) and panel the box contains, e.g. "Panel E - Cir. 16-18-20."

Section Number	Title
-------------------	-------

Branch circuits shall be tagged in panelboards and pullboxes, using as-installed circuit numbers. Tags to be plainly marked with indelible ink, and securely attached to the wires.

All power outlet faceplates shall be labeled to indicate source circuit and panel.

Transformers, switches, equipment, pullboxes, cabinets, junction boxes and gutters having voltages of more than 600 volts shall be identified as to the voltage of the system within. Letters and numbers shall be a minimum of 2" and are to be highly visible contrasting colors. "DANGER - HIGH VOLTAGE - KEEP OUT" signs shall be permanently attached to the primary section door on transformers and on doors of sectionalizing switches of 600 volts or more. Signs shall be bilingual Spanish/English, and sized according to OSHA codes.

Service entrance main circuit breaker shunt trip panic buttons shall be marked "EMERGENCY-POWER OFF SWITCH" with a red and white laminate label.

Fire alarm system conduit shall be field-painted red, or shall be factory red topcoat colored conduit, or shall be labeled with 2" wide, red, heavy duty, indoor/outdoor rated, pressure-sensitive adhesive-backed flexible high-gloss vinyl tape, similar to Brady #55261 pipebanding tape. For tape-labeled conduit, clean surface with isopropyl alcohol and completely encircle the conduit in half-lapped turns of tape with the last two turns applied with no tension to prevent possible unwinding. Tape shall be installed maximum of 10' on center and within 3' of all changes of direction.

Fire alarm system boxes shall be red and shall be labeled "F/A" in 1" indelible black lettering.

All Fire Alarm Signaling Line Circuit/Initiating Device Circuit (SLC/IDC) devices shall have labels physically applied, noting both the Signaling Line Circuit/Loop number and the sequential device number; i.e., "S209" for a Signaling Line Device, sequential number nine (9), located on Signaling Line Circuit/Loop number two (2).

All Fire Alarm Notification Appliance Circuit (NAC) devices shall have labels physically applied, noting whether the Notification Appliance is fed from the fire alarm control panel (FACP) or a Remote Power Supply, the Notification Appliance Circuit/Loop number and the sequential device number; i.e., "N209" for a Notification Appliance Circuit Device sequential number nine (9), located on Notification Appliance Circuit/Loop number two (2), fed from the FACP, or "NP209" for a Notification Appliance Circuit Device sequential number nine (9), located on Notification Appliance Circuit/Loop number two (2), fed from a Notification Remote Power Supply.

Section Number	Title
-------------------	-------

Labels for both SLC/IDC and NAC devices shall be ½", clear flexible vinyl pressure-sensitive adhesive-backed, thermal transfer printed labels with ¼" high, black lettering, similar to Brady #M71C-500-580-CL. Label shall be mounted on flat plane of the metal ceiling tile support grid, directly adjacent to device, or on a non-curved surface of the actual device. Label shall be installed plumb. Installers hands shall be clean and shall clean the surface with isopropyl alcohol prior to installation of label t, such that label properly adheres and does not show installer fingerprints.

All fire alarm head-end equipment shall have large red micarta label with two lines of ½" high, white, engraved lettering, physically adhered to the cover, plumb, and attached with minimum of (2) 3/16" diameter rivets and a flat washer. The first line shall indicate the type of head-end equipment, and the second line shall indicate the equipment's physical location, including building number, floor level, and nearest column intersection; i.e., "FACP B24-1-K/2" for a Fire Alarm Control Panel located in Building 24, level one, near column K/2. Labels shall use the following acronyms:

- FACP – Fire Alarm Control Panel
- FAAP – Fire Alarm Annunciator Panel (Text)
- NP – Fire Alarm Notification Remote Power Supply
- FGAP – Fire Alarm System Graphic Annunciator Panel

26 09 00 Instrumentation and Control for Electrical Systems

26 09 13 Electrical Power Monitoring and Control

Part 1 – General

Provide data connection for metering. Coordinate requirements with NAU IT.

Part 2 – Products

Service entrance switchboards or panelboards shall be provided with an electronic meter with the following functions (per phase as applicable): ammeter, voltmeter, kilowatt demand, kilowatt-hour, harmonic distortion. Meter shall be capable of communication by non-proprietary protocol. Owner has pre-approved the following product to be in compliance with these standards: Veris E50H5, Enhanced Power and Energy Meter.

New medium voltage box pad mounted switchgear shall be provided with integral bus voltage and current metering and switch position monitors that shall report to the central metering system at the North Plant via fiber optic pathway.

Determine requirements for submetering of systems necessary to comply with measurement and verification of HVAC and other building systems.

Section
Number

Part 3 – Execution

Metering must be energized and programmed when the electrical system is energized. The electrical contractor and commissioning agent is to verify readings at that time. Communication with EMS can be setup at a later date but trending must be setup prior to substantial completion. Refer to Division 23 for EMS requirements.

26 09 43 Network Lighting Controls

Part 1 – General

The system shall be digital.

Lighting Control Panel (LCP) shall fail in the last switched state in the event of a power failure. LCP to have individual nonproprietary relays capable of being removed and replaced individually without interruption of any other relays. LCP shall have one relay per load in its own separate package (not two or more relays built together as a unit). Relays shall be mechanically locking with the capability to manually switch each relay individually for maintenance, troubleshooting, and in the event of LCP or relay failure (relays to have a manual actuator).

Relays shall be UL20 listed, plug load rated, with heavy duty contacts.

Relays shall be 30 amp rated for ballast lighting loads.

Relays shall have a pluggable connector on external low voltage control wires with which to tie the relay to the LCP.

Means of connecting switching devices to the LCP shall be Cat5 minimum, not hard wired, with multiple switching devices being series connected capable.

The lighting control system shall have a hand held configuration tool for remote configuring of devices without the use of a ladder or tools.

Two configuration tools shall be provided to Owner.

Part 2 – Products

Owner has pre-approved the following manufacturer to be in compliance with these standards: Watt Stopper.

Part 3 – Execution

N/A

****END OF SECTION****

Section Title
Number

Section Title
Number

26 10 00 MEDIUM VOLTAGE ELECTRICAL DISTRIBUTION

See Division 33 for all components over 600 volts.

****END OF SECTION****

Section Title
Number

26 20 00 LOW VOLTAGE ELECTRICAL TRANSMISSION

26 22 00 Low Voltage Transformers

Part 1 – General

N/A

Part 2 – Products

Transformer windings shall be copper.

Part 3 – Execution

Dry transformers shall not be suspended or wall-mounted unless specifically approved by Owner (Electrical Department).

26 24 00 Switchboards and Panels

26 24 13 Switchboards

Part 1 – General

Refer to Division 33, for metering requirements for service entrance switchboards.

Part 2 – Products

Switchboards and switchgear

Owner has pre-approved the following manufacturer to be in compliance with these standards: Square D.

All bussing shall be copper.

Panic buttons

Mushroom head push buttons are not acceptable.

Owner has pre-approved the following products to be in compliance with these standards: Allen Bradley #800T-BGA extended head red push button unit with Allen Bradley #800-N13 extra long guard ring.

Overcurrent devices with adjustable trip characteristics shall be set in the field by the installing contractor, per the settings of the coordination study performed by the Design Professional.

Part 3 – Execution

Section Title
Number

Panic buttons shall be installed in the electrical service entrance room at the exit(s). These panic buttons shall be wired to a shunt trip main breaker and in parallel with the ground fault trip (where applicable).

26 24 16 Panelboards

Part 1 – General

N/A

Part 2 – Products

Panelboards shall be as commercial grade, copper bus, circuit breaker type, hinged door in hinged door, painted gray with manufacturer's standard finish, keyed alike, without pre-punched knockouts. Main breaker shall be provided, center mounted in line with bus. Owner has pre-approved the following manufacturers to be in compliance with these standards: Square D, General Electric (bolt-on type), Siemens, Eaton, or approved equal.

Panelboards shall be circuit breaker type. Circuit breakers in 120/208 volt and 277/480 volt panelboards shall be bolt-on breakers. Breaker numbers shall be stamped on the deadfront; decal numbering is not allowed.

Load centers are not allowed.

Panic buttons

Mushroom head push buttons are not acceptable.

Owner has pre-approved the following products to be in compliance with these standards: Allen Bradley #800T-BGA extended head red push button unit with Allen Bradley #800-N13 extra long guard ring.

Submit sample directory with material submittals.

Part 3 – Execution

If the building is served by a service entrance panelboard, panic buttons shall be installed in the electrical service entrance room at the exit(s). These panic buttons shall be wired to a shunt trip main breaker.

When more than one panelboard is installed at the same location, the tops of the panelboards shall be mounted at the same height.

Furnish and install a neat, plastic-covered typed and printed circuit directory inside of each panelboard door. Directory shall indicate equipment or area(s) of building or equipment supplied by each circuit. Use as-built room numbers affixed on doors

Section
Number Title

or as designated by Owner (Project Manager). Minimum size shall be 5" x 8" for panels up to 20 circuits; two for panels above 20 circuits, or 6" x 11".

Overcurrent devices with adjustable trip characteristics shall be set in the field by the installing contractor, per the settings of the coordination study performed by the Design Professional.

26 25 00 Enclosed Bus Assemblies

Part 1 – General

N/A

Part 2 – Products

N/A

Part 3 – Execution

Busways shall be installed with wall flanges at all wall penetrations. Floor penetrations shall have a sealed 1" minimum lip above finished floor.

26 27 00 Low Voltage Distribution Equipment

26 27 26 Wiring Devices

Part 1 – General

Receptacle outlets in office areas and classrooms, designated for instruction in the use of office or lab equipment, shall be laid out at a maximum of 6' on center.

Lighted toggle switches shall be used in all tunnels and equipment rooms.

Dual technology motion sensing switches shall be specified for all office, restroom, classroom, and storeroom areas, and other areas with more than six two-lamp fixtures. All motion sensors shall be equipped with a manual switch.

Toilet rooms shall be equipped with motion sensing switches for both lights and fans. Motion sensors shall be equipped with a toggle sensor.

All exterior receptacles, and interior receptacles within 6' of a water source (such as a sink, eye wash, drinking fountains, emergency showers, hose bibbs, etc.), shall be GFCI protected.

Part 2 – Products

Section Title
Number

Wiring devices shall be 20A, specification grade, back or side wired standard National Electrical Manufacturers Association (NEMA) configuration. 15A devices and push-on devices are not allowed.

Cover plates shall be specification grade, nylon. Plate color shall match devices. Plates in exposed wiring shall be steel, rounded to box edge. Oversized plates are not allowed. Type 302 stainless steel shall be installed in all equipment and mechanical spaces.

Owner has pre-approved the following products to be in compliance with these standards:

- Receptacles & GFCI receptacles: heavy-duty specification grade, Hubbell 5362.
- Surge-suppression isolated-ground receptacles: Hubbell IG5362S.
- Isolated Ground: Hubbell IB5362BR.
- Toggle switches: Hubbell 1221.
- Lighted toggle switches: white or clear only, Hubbell 1221LC.
- Pilot light toggle switches: Hubbell 1221PLC.
- Momentary-contact switches: 3-position, single-pole double-throw, Hubbell 1557.

Devices and cover plates on emergency power shall be red. Cover plates shall be engraved "Emergency Power."

Part 3 – Execution

All device wiring shall be pigtailed.

Horizontal receptacles shall be installed so that the neutral is to the top. Vertical receptacles shall be installed so that the ground is to the top.

All devices shall be grounded to the conduit system, the box ground screw, and the circuit equipment grounding conductor.

Receptacles shall be 18" AFF to center of receptacle, or 48" or 40" where table, work benches and counters occur, or as noted.

Mount wall switches on the latch side of doors. All switches shall be 48" AFF to the center of the switch, except where located in cabinets.

26 29 00 Low Voltage Controllers

26 29 13 Enclosed Controllers

Section
Number Title

Part 1 – General

Provide combination fused-switch magnetic motor starters or variable frequency drives on all motors 1 hp or larger.

Provide loss-of-phase protection on all 3-phase motors.

Provide motor-rated switches with overloads on small single-phase motors.

Part 2 – Products

Controllers shall be heavy-duty (HD), with green and red pilot lights, and operate on 120V control circuits. Owner has pre-approved the following manufacturers of enclosed controllers to be in compliance with these standards: Square D, General Electric, Siemens, Eaton, Crouse-Hinds.

Small single-phase motors shall be protected by a motor-rated switch at the motor location, or shall be provided with integral overload protection and a fuse stat at the motor location. Owner has pre-approved the following product to be in compliance with these standards: Allen-Bradley Bulletin 600 motor-rated switch.

Part 3 – Execution

N/A

26 29 23 Variable Frequency Motor Controllers

Part 1 – General

Do not locate drive inside of air handling units.

On equipment with Variable Frequency Drives, (VFD) provide a separate disconnect and contractor to start and operate equipment when the VFD fails.

Control wiring shall be in separate steel conduit from the motor feeder.

De-rate VFDs for installed altitude.

Part 2 – Products

VFDs shall be pulse-width modulated. All VFDs shall be the product of the same manufacturer. Owner has pre-approved the following manufacturer to be in compliance with these standards: ABB (ACH Series).

Indoor enclosures shall be NEMA 12. Outdoor enclosures shall be NEMA 4.

Section
Number Title

Match type of drive to actual load driven (i.e. variable torque or constant torque).
Coordinate use of VFD rated motors with Owner (HVAC department).

Provide 5% line reactors, electromagnetic interference filter/radio frequency interference filter (EMI/RFI) filtering, door-interlocked input circuit breaker or fused switch, and contactor bypass.

Coordinate communications protocol and control signal type with other Divisions of these Technical Standards.

Part 3 – Execution

Complete operation and maintenance manuals shall be provided to Owner prior to conducting the onsite training. The operation and maintenance manual shall contain a complete copy of the submittal documents. Training shall at a minimum consist of four hours of onsite training by a certified factory representative. The training shall be scheduled after the VFDs are in service and fully operational.

Install a fused bypass disconnect externally piped around the VFD.

****END OF SECTION****

Section Title
Number

26 30 00 FACILITY ELECTRICAL POWER GENERATING AND STORING EQUIPMENT

26 32 00 Packaged Generator Assemblies

26 32 13 Engine Generators

Part 1 – General

Generators shall be diesel-fueled. Access for fuel trucks must be provided.

Means shall be provided for shutting down the engine at the entrance to the generator room or enclosure. This shall be labeled "Generator Emergency Stop."

Outdoor generators shall be provided with skid-mounted double-wall steel fuel tank. Indoor generators shall be provided with an outdoor double-wall steel fuel tank.

Derate generators for installed altitude.

Part 2 – Products

Generator Emergency Stop

Mushroom head push buttons are not acceptable.

Owner has pre-approved the following products to be in compliance with these standards: Allen Bradley #800T-BGA extended head red push button unit with Allen Bradley #800-N13 extra long guard ring.

Part 3 – Execution

Generators which are installed in structures, or at outside locations, shall have adequate emergency lighting equivalent to normal lighting.

A complete test of the entire emergency electrical system, including load banking of generator and testing of each automatic transfer switch with the generator shall be performed on or before substantial completion of project.

Overcurrent devices with adjustable trip characteristics shall be set in the field by the installing contractor, per the settings of the coordination study performed by the Design Professional.

26 36 00 Transfer Switches

Part 1 – General

Section
Number Title

Transfer switches shall be 4-pole (switched neutral), except when adding a transfer switch to an existing emergency electrical system which is based on 3-pole topology.

Part 2 – Products

N/A

Part 3 – Execution

N/A

****END OF SECTION****

Section Title
Number

26 40 00 ELECTRICAL AND CATHODIC PROTECTION

26 41 00 Facility Lightning Protection

26 41 13 Lightning Protection for Structures

Part 1 – General

Lightning Protection Risk Analysis: Prepare and submit calculations as described in Annex L of NFPA 780. Use this analysis to make recommendation to Owner on the provision of a lightning protection system.

Part 2 – Products

N/A

Part 3 – Execution

N/A

26 43 00 Transient Voltage Suppression

26 43 13 Transient Voltage Suppression for Low Voltage Electrical Power Circuits

Part 1 – General

Two levels of transient voltage surge suppression (TVSS) or surge protective device (SPD) are required to protect electrical distribution equipment serving computer-intensive and/or critical information dependent areas and offices. These levels do not include receptacle-level TVSS.

Part 2 – Products

Surge protection devices shall have a 10 year warranty, all modes of protection, and active phase indicator lights.

Part 3 – Execution

N/A

****END OF SECTION****

Section Title
Number

26 50 00 LIGHTING

26 51 00 Interior Lighting

Part 1 – General

Lighting concepts and recommended illuminance levels per the Illuminating Engineering Society of North America (IESNA) Lighting Handbook and Recommended Practices (latest editions) shall govern the lighting design.

The lighting shall be designed for maximum efficiency, incorporating energy saving fixtures and daylighting when possible. Allowed Lighting Power Density (LPD) figures shall follow ASHRE 90.1.

Lighting fixtures shall utilize lamps that match the campus standards. Select fixtures and light sources with long operating lives; which utilize controlling elements (lenses, louvers, reflectors, etc.) designed to provide the best utilization of emitted light at the task location; that are appropriate for the ambient temperature; and that are not prone to dirt accumulation.

Fluorescent lighting for athletic or machinery spaces shall be circuited to minimize "strobe" effect.

LED shall be used for parking garages and under covered outdoor locations.

In high ceiling areas, locate fixtures for maintenance access or provide access for maintenance equipment.

Task lighting shall be used in order to reduce the general lighting load.

Suitable listed fixtures shall be specified and installed in fire-rated ceilings.

Wall-grazing lighting (fixtures mounted where the wall and ceiling intersect) will highlight irregularities in tile walls, gypboard walls, or wall coverings. Wall grazing lighting should only be used when the wall is highly textured by design. Wall washing lighting (fixtures at least 24" off the wall to the closest edge of fixture) is preferred.

The preferred method of powering egress and exit lighting is (in order of most preferred to least preferred) engine-generator (if present), and integral battery packs. Battery packs shall be approved by Owner via a submittal.

In renovation projects where existing fixtures are to be re-used, they shall be retrofitted with new ballasts and lamps as specified herein.

Section Title
Number

In existing buildings, emergency battery ballasts in unswitched normal power fixtures shall be used. An acceptable alternate is sealed beam emergency lights with individual power packs, circuited to a normal power panel.

Projects requiring emergency power shall have a feasibility study, examining central inverter or generator vs. individual battery packs. Short battery life and inverters and high maintenance costs of battery packs should be considered in the study.

The following design parameters are provided as guides only for conceptual calculation for electrical and lighting loads.

<u>AREA</u>	<u>FOOTCANDLES</u>
Computer Labs	20-30
Library Reading Rooms	50
Calculating Rooms	50
Drafting Rooms	75
Accounting Rooms	50
Proofreading Rooms	75
Classrooms	50
Laboratories	75
Seminar Rooms	50
Offices	30-50
Toilet Rooms	10
Kitchens	30
Locker Rooms	10
Store Rooms	20
Corridors & Stairs (academic and offices)	25
Corridors & Stairs (dormitories)	10
Machine Rooms	20
Building Entrances (interior)	Same as corridors

Supplemental local illumination shall be provided wherever required to give the following local intensities:

Shop work at machines or benches	75
Displays	75
Demonstration Tables or Areas	60

Part 2 – Products

Lamps

Owner has pre-approved the following manufacturers to be in compliance with these standards: General Electric, Voss, Westinghouse, Sylvania, Phillips.

Section Title
Number

Linear 4 ft fluorescent lamps shall be 21 watt energy-saving T-5 type, 4100K, 20,000 hr life rated, CRI > 75. Four foot lamps are the standard. 8 ft and U-bend lamps shall not be used.

Exit lights shall be red LED type.

All fixtures operating in low temperatures shall be supplied with low temperature ballasts.

Ballast wiring shall be connected in accordance with 2011 NEC Article 410.130 (G). Owner has pre-approved the following product to be in compliance with these standards: WAGO LUMI-NUTS disconnect.

Fluorescent ballasts shall be high efficiency T5 instant start universal voltage electronic type with total harmonic distortion less than 20%, power factor 95% minimum, lamp current crest factor 1.6 or less, sound rating "A," and minimum five year material and labor replacement warrantee. Ballast preference is Sylvania Quicktronic T5 with normal and low ballast factor. High ballast factor must be approved by the Owner (Electrical Department's Supervisor). Owner has pre-approved the following manufacturers to be in compliance with these standards: Ballast, Valmont (Ultramizer), Advance, Motorola, EBT, Magnetek (Triad).

Part 3 – Execution

In 277V lighting systems where inside tubes and outside tubes are switched separately, the same phase shall be used for each fixture so that 480V will not be accessible in the fixture.

Wiring for fixtures in accessible ceilings shall be accessible after fixture installation, without requiring removal of the fixture from the ceiling.

Fixtures mounted in plaster or drywall ceilings shall be rigidly supported with channel supports across plaster framing. Mount all fixtures with a minimum of three 1/4" bolts for 1' x 8' fixtures, two 1/4" bolts for 1' x 4' fixtures, and four 1/4" bolts for 2' x 4' fixtures.

Recessed fixtures shall be supported to the building structure (not the roof deck). All fixtures shall be supported on at least two points (opposite corners each individual fixture) with #12 gauge ceiling wire with a minimum of 3 twists of wire at each point of attachment. Two or more wires shall not be supported by a single anchor. Two or more fixtures shall not be supported by a single wire. Points of attachment and anchoring shall be approved by the Design Professional. Install strut channel as necessary to provide support between building structural points.

Section Title
Number

Lighting within mechanical rooms, electrical rooms or above ceilings shall not be connected by electrical cord.

26 56 00 Exterior Lighting

Part 1 – General

See Design Guidelines for Exterior Lighting requirements.

Part 2 – Products

Owner has pre-approved the following manufacturers to be in compliance with these standards: KIM ALT60.

Part 3 – Execution

Poles shall be 12' high for walkways, 16' high for parking lots, and 20' high for roadways.

A 20' coil of #4 bare copper wire in contact with earth at the bottom of a pole base excavation will be installed.

****END OF SECTION****

Section Number	Title
27 00 00	COMMUNICATIONS
27 01 00	Operation and Maintenance of Communications Systems
27 01 10	Operation and Maintenance of Structured Cabling and Enclosures
27 01 20	Operation and Maintenance of Data Communications
27 01 30	Operation and Maintenance of Voice Communications
27 05 00	Common Work Results For Communications
27 05 13	Communication Services
27 05 13.43	Cable Services
27 05 26	Grounding and Bonding for Communications Systems
27 05 28	Pathways for Communications Systems
27 05 28.29	Hangers and Support for Communications Systems
27 05 28.33	Conduits and Back Boxes for Communication Systems
27 05 28.36	Cable Trays for Communications Systems
27 05 28.39	Surface Raceways for Communications Systems
27 05 28.40	Furniture Raceways and Pathways
27 05 43	Underground Ducts and Raceways for Communication Systems
27 10 00	STRUCTURED CABLING
27 11 00	Communications Equipment Room Fittings
27 11 13	Communications Entrance Protection
27 11 16	Communications Cabinets, Racks, Frames, and Enclosures
27 11 19	Communications Termination Blocks and Patch Panels
27 11 23	Communications Cable Management and Ladder Rack
27 11 26	Communications Rack Mounted Power Protection and Power Strips
27 13 00	Communications Backbone Cabling
27 13 13	Communications Copper Backbone Cabling
27 13 13.01	Intra Building Copper Backbone
27 13 13.02	Inter Building Copper Cable Backbone
27 13 13.13	Communications Copper Cable Splicing
27 13 13.14	Copper Cable Testing
27 13 23	Communications Optical Fiber Backbone Cabling
27 13 23.01	Building Optical Fiber Cable Backbone
27 13 23.02	Inter Building Optical Fiber Cable
27 13 23.13	Optical Fiber Splicing and Terminations and Testing
27 15 00	Communications Horizontal Cabling
27 15 01	Communications Horizontal Cabling Applications
27 15 01.16	Voice Communications Horizontal Cabling
27 15 01.19	Data Communications Horizontal Cabling
27 15 01.20	Wireless Data Communication Horizontal Cabling
27 15 43	Communications Faceplates and Connectors

Section Number	Title
27 16 00	Communications Connecting Cords, Devices, and Adapters
27 16 13	Communications Custom Cable Assemblies
27 16 16	Communications Media Converters, Adapters, and Transceivers
27 16 19	Communications Patch Cords, Stations Cords, and Cross Connect Wire
27 20 00	DATA COMMUNICATIONS
27 21 00	Data Communications Network Equipment
27 30 00	VOICE COMMUNICATIONS SWITCHING AND ROUTING EQUIPMENT
27 31 00	Voice Communications Switching and Routing Equipment
27 32 00	Voice Communications Telephone Sets, Facsimiles, and Modems
27 32 23	Elevator Telephones
27 32 26	Ring-Down Emergency Telephones
27 33 00	Voice Communications Messaging
27 34 00	Call Accounting
27 35 00	Call Management
27 40 00	AUDIO-VIDEO COMMUNICATIONS

Section
Number

Title

27 00 00

COMMUNICATIONS

27 01 00

Operation and Maintenance of Communications Systems

Part 1 – General

It is the responsibility of the Owner (Information Technology Services department) to ensure that a fully compliant and efficient communication infrastructure is in place for the Owner's needs. These standards are in place to accomplish that goal. These standards are for the use of all campus departments as well as all Design Professionals, developers and Contractors involved in construction on campus. All Work shall be in accordance to Building Industry Consulting Services International (BICSI) recommended installation practices and standards/ codes stated below. Coordination with Owner (Project Manager and ITS department) shall be required prior to actual construction and wiring placement. Owner has pre-approved the following manufacturer to be in compliance with these standards: Ramtel. Model number pre-approved by Owner (ITS).

Quality Assurance

The following requirements must be met by the telecommunications contractor, whether that contractor is hired directly by Owner as the prime Contractor or hired by the Contractor as a subcontractor.

- A. The telecommunications contractor shall have a Registered Communications Distribution Designer (RCDD) with Outside Plant (OSP) Design Certification as a company employee for the company and on project staff, and shall be an approved Belden Certified Installer.
- B. A copy of the certification documents of the firm and the installers must be submitted to Owner for verification that certification requirements are met prior to receipt of bids.
- C. All price quotes with the specified warranty solution submitted to Owner for approval shall have all the part numbers and documents pertaining to the specifications of the materials being used for the project being quoted along with as-builts pertaining to BDF/IDF layouts.
- D. The system shall be designed by a RCDD/OSP certified designer.
- E. The system installer shall perform overall project management/installation oversight by a BICSI certified RCDD/ OSP on a weekly basis.
- F. The system installer shall have a certified BICSI Technician as the lead technician, employed on staff and on-site during project construction at all times. The lead technician shall be OSHA 30 trained and verified.
- G. All installers/technicians shall be BICSI certified or enrolled in a State authorized apprenticeship program. New members added to the installation team must be approved by Owner (ITS). All members of the installation team shall be OSHA 10 trained. A copy of current certifications of all members of the installation team shall be submitted with the quote.
- H. A system warranty for 25 years covering all components, equipment and workmanship shall be submitted in writing with system documentation as

Section Number	Title
	part of the closeout process. Owner has pre-approved the following solutions to be in compliance with these standards: SureBit, ChannelMate.
I.	Should the cabling system fail to perform its expected operation within the contractor warranty period due to inferior or faulty installation and/or workmanship, the contractor shall promptly make all required corrections without cost to Owner.
J.	Copper System shall be complete Belden SureBit/ChannelMate Solution System. No mixing of warranty solutions will be allowed in a building. Faulty materials shall be promptly corrected by the manufacturer at no cost to Owner.
K.	Verify with Owner for intended warranty on a per job basis.
L.	Fiber optics shall be Belden.
M.	No portion of the telecommunications cabling contract may be subbed out to another entity unless prior approval is granted by Owner.
N.	All subcontractors/ contractors shall wear in plain sight photo ID at all times during project construction stating company name, employee name and current BICSI credential.
O.	Removal of all abandoned cabling shall be included in all Telecommunications installations and upgrades.
P.	Owner has pre-approved the following manufacturers to be in compliance with these standards: Belden

Note: Preliminary as-builts shall be included in Contractor's quote and provided prior to Substantial Completion of project.

Prior to sign-off of the FS #15 at time of Substantial or Final completion and release of payments: Owner reserves the right to test and verify compliance of all fiber and copper cables installed under contract.

Codes and Standards Compliance

- A. Reference Division 01 41 13 for applicable codes.
- B. All materials and installation practices shall comply with the applicable sections of the following telecommunications industry standards and all applicable addendums:
 1. ANSI/TIA/EIA-569-C.0-2009+A1:2010+A2:2012, Generic Telecommunications Cabling for Customer Premise Standard
 2. ANSI/TIA/EIA-568-C.1-2009+A1:2012, Commercial Building Telecommunications Cabling Standard,
 3. ANSI/TIA/EIA-568-C.2-2009+A1:2010, Balanced Twisted Pair Telecommunications Cabling and Components Standard

Section Number	Title
4.	ANSI/TIA/EIA-568-C.3-2009+A1:2010,Optical Fiber Telecommunications Cabling Systems Standard
5.	ANSI/TIA/EIA-568-C.3-2009+A1:2011, Optical Fiber Cabling and Components Standard
6.	ANSI/TIA/EIA-568-B.2-1: Transmission Performance Specification for 4-Pair 100 Ω Category 6 Cabling (Standard).
7.	ANSI/TIA/EIA-569-C-2012, Commercial Building Standards for Telecommunications Pathways and Spaces
8.	ANSI/TIA/EIA-570-C-2012, Residential Telecommunications Infrastructure Standard
9.	ANSI/TIA/EIA-606-B-2012, The Administration Standard for Commercial Telecommunications
10.	ANSI/TIA/EIA-607-B-2013, Commercial Building Grounding (Earthing) and Bonding Requirements for Telecommunications
11.	NECA/BICSI 607-2011 or current revision, Standard for Bonding and Grounding Planning and Installation Methods for Commercial Buildings.
12.	ANSI/TIA/EIA-758-B-2012, Customer Owned Outside Plant Telecommunications Infrastructure Standard
13.	TIA/EIA-1005-A-2012 Telecommunications Infrastructure Standard for Industrial Premises
14.	BICSI/NECA-607 Telecommunications Bonding and Grounding, Planning and Installation Methods for Commercial Buildings
15.	TIA/EIA-942-A-2012 Telecommunications Infrastructure Standard for Data Centers
16.	TIA-TSB-190, 2011 Guidelines on Shared Pathways and Shared Sheath
17.	NFPA 780- Standard for Installation of Lightening Protection Systems, latest issue
18.	Telecommunications designers/ Contractors and installers shall have read the above documents and must be familiar with the requirements that pertain to this installation. The documents may be obtained from:
	IEEE-Institute of Electrical and Electronics Engineers, Inc., 345 East 47th Street, New York, NY, 10017-2394, 800-678-IEEE, fax: 732-981-9667, http://standards.ieee.org/

For any questions or further information on Owner's ITS cabling standards, designs and layouts, please contact Owner for clarification.

Part 2 – Products

N/A

Section Number	Title
	<p><u>Part 3 – Execution</u> Any design or installation that does not meet all applicable codes and standards shall be remediated by the Contractor at no charge to Owner.</p>
27 01 10	<p>Operation and Maintenance of Structured Cabling and Enclosures</p> <p>The operation and maintenance of all structured cabling systems are the responsibility of Owner and any and all changes or modification shall be coordinated with Owner (NAU ITS).</p>
27 01 20	<p>Operation and Maintenance of Data Communications</p> <p>The operation and maintenance of all data communications are the responsibility of Owner and any and all changes or modification shall be coordinated with Owner (NAU ITS).</p>
27 01 30	<p>Operation and Maintenance of Voice Communications</p> <p>The operation and maintenance of all voice communications are the responsibility of Owner and any and all changes or modification shall be coordinated with Owner (NAU ITS).</p>
27 05 00	Common Work Results For Communications
27 05 13	<p>Communication Services</p> <p>All voice and data communication services to be supplied by or coordinated with Owner (NAU ITS). This includes dial tone services, T1 services, DSL services, Network services.</p>
27 05 13.43	<p>Cable Services</p> <p><u>Cable Television Equipment and Signal;</u></p> <p>The system shall meet or exceed ALL technical standards set forth in FCC Rules & Regulations Part 76; http://www.ecfr.gov/cgi-bin/text-idx?c=ecfr&sid=3100d6c36aa8d24cb14d0de0e94df597&tpl=/ecfrbrowse/Title47/47cfr76_main_02.tpl</p> <p>Band width of ALL active and passive devices shall have a minimum of 54 MHz to 860 MHz (forward/downstream) and 5 MHz to 42 MHz (reverse/upstream).</p>

Section
Number

Title

All CATV/ TV locations shall consist of (2) station cable and (1) drop cable as listed below

Station Location

All Category 6 cables to TV locations shall consist of a minimum two (2) Category 6 100ohm White cable terminated in the BDF on its own Category 6 Patch Panel. If distance is an issue than the cable will terminate in the closest IDF/ TR within the distance limitation.

Drop Cable

RG-6 series with a minimum 60% braid (minimum SCTE standard); 18 AWG copper covered steel center conductor; foam dielectric material (FEP); inner shield aluminum-poly, bonded – 100% aluminum laminated tape with overlap bonded to dielectric; outer shield of 34 AWG bare aluminum braid wire; jacket of polyvinyl chloride (PVC) plenum rated material.

Feeder Cable;

0.500 P3 series copper clad aluminum center conductor: expanded polyethylene dielectric; solid aluminum sheath; outer jacketed of black high molecular weight polyethylene.

Trunk Cable;

0.750 P3 series copper clad aluminum center conductor; expanded polyethylene dielectric; solid aluminum sheath; outer jacket of black high molecular weight polyethylene.

Connectors;

Drop cable; RG-6 compression type. CROSS REFERENCE: ICM F-CONN#FS6PL2/Corning-Gilbert#GF-UR-6-PL.

Feeder cable; .500 pin type Gilbert #GRS 500CH-DU-01

Trunk cable; .750 pin type Gilbert #GRS 750CH-DU-01.

Fiber (singlemode); “APC” type SC/FC (min.-60dB return-loss).

Distribution, fiber nodes, RF Amplifiers;

All equipment shall be installed & labeled in appropriate equipment rooms as designated by project/design. All cable drops shall be home runs to the designated equipment rooms and labeled with its corresponding room number. Fiber nodes/RX's and RF amplifiers shall be premise power type (115VAC). It is recommended that these active components be of the same manufacturer/model type currently being utilized throughout the campus CATV system. CROSS REFERENCE: Scientific Atlanta mod. #90090 (fiber Rx/amplifier), Blonder Tongue

Section Number	Title
	mod. #FRDA/FRRA (wall/rack mount fiber Rx/amplifier), Blonder Tongue mod. #BIDA (RF distribution amplifier).

Back-up/spare “active” equipment shall be provided by the Contractor.

ALL active/passive components as well as any other equipment or specifications outlined in this standards sheet should be discussed with Owner personnel prior to any design, purchase and/ or implementation.

Note: As-builts shall be included in contractors quote and provided prior to Substantial Completion of project.

27 05 26	Grounding and Bonding for Communications Systems
----------	--

A Telecommunications Main Grounding Bus bar (TMGB) connected to the electrical grounding system is required in all buildings. All communication equipment spaces require a Telecommunication Grounding Bus bar (TGB) connected to the TMGB and bonded to approved building ground. All connections bonded with a minimum 6 AWG conductor. All cable tray, equipment racks, and equipment cabinets bonded to TGB. All Telecommunication protectors and associated metallic cable sheaths to be grounded to selected TGB with a minimum 6 AWG insulated conductor. All copper pairs to be protected at building entrance facility with gas tube type 350VDC protector modules.

27 05 28	Pathways for Communications Systems
----------	-------------------------------------

All communication cabling shall be routed in a designed and approved pathway system per ANSI/TIA/EIA-569-C, (Commercial Building Standard for Telecommunications Pathways and Spaces) and meet or exceed all National, State and Local codes and standards. Pathways shall run parallel to the building design. Design shall be documented in floor plans and have built in flexibility for tenant movement and expansion and designed for maintenance and relocation of cables as easy as possible. Any and all pathway sleeves shall be rigidly secured on both sides of the wall. ISP and OSP fiber optic cabling that is not in conduit shall be placed inside plastic inner-duct unless an armored cable is used for safety, identification and protection of the fiber. Pathways shall not exceed 40% initial fill volume when installed. Pathways shall not exceed 40% initial fill volume when installed. When necessary additional sleeves and pathways shall be installed to meet the standard to not exceed 40% initial fill volume. A free and clear pull-line with minimum 200lb pull rating will be available for future use will be left in all main bundles/pathways and conduits. All cable colors to be bundled separately in the ceiling and in all BDF's/ IDF's or TR's.

When cables enter the closets they will be packed neatly (i.e. cigarette packing)

Section Number	Title
	OSP pathways refer to Div. 33 80 00 for standards for pathways.
	Fire Wall penetrations shall be installed in accordance to the current Division 21 specifications. Owner has pre-approved the following manufacturers for pre-fabricated fire stop solutions to be in compliance with these standards: 3M, Hilti and STI (Specified Technologies Inc.).
27 05 28.29	<p>Hangers and Support for Communications Systems</p> <p>All cable supports shall be located on maximum of 48" on center and attached to both sides and ends of cable tray. All cable tray systems shall be comprised of the manufacturers recommended hardware for a complete system. All cable supports shall be rated for Fiber Optic, Category 6 and 6a structured cabling system. In a ceiling distribution design a minimum of 3" clearance between ceiling tile and cable or the lowest point in the support/anchoring of the communications system. All hangers and supports must be suspended from or attached to the structural ceiling or walls with hardware designed to support the tray's maximum load bearing rate. Only Velcro-type cable straps shall be used for dressing or securing Fiber Optics, Category 6 and 6a Cabling. J-Hook or straps for the support system shall be installed no greater than 48" on center and in accordance to all BICSI Design standards and best practices.</p>
27 05 28.33	<p>Conduits and Back Boxes for Communication Systems</p> <p>All conduits shall be rigid. Flexible conduit is not acceptable for any application. Design and installation of conduits shall be run in most direct route possible with no more than two 90-degree bends and should not contain any electrical condulets (LB's). Conduit should not be placed over or adjacent to boilers, incinerators, hot water lines, electrical convertors/rectifiers/panels or steam lines. Conduits 2" or smaller require a bend radius of 6 times the internal conduit diameter, more than 2"require 10 times the internal conduit diameter. All conduit ends should be reamed and fitted with insulated bushing. Specify a minimum two 1" conduits to each office type room on opposite walls and stubbed out to accessible location in the same room. All other rooms (labs, classrooms, etc.) require consultation with Owner. Conduits to terminate in a 5"x5" double gang box with a single gang device cover and routed to communication cable tray or stubbed to accessible location. Equip all conduits with a pull cord that has a minimum test rating of 200 lb. All conduits dedicated to communication structured cabling system and shall not be shared with any other services. Underground conduits that contain telecommunications cables shall terminate with Conduit End Bells inside the BDF/IDF, vault or manhole and sealed after, whether in use or not. Conduits seals shall be re-enterable. Type of seal shall be approved by Owner. No rigid foams permitted.</p>

Section Number	Title
27 05 28.36	Cable Trays for Communications Systems

Type and design of cable tray distribution system shall be pre-approved by Owner. Cable tray installation must be installed to meet NEC article-392 and all state and local codes. Cable tray shall be dedicated to telecommunication use only and not shared with electrical. A/V (Audio/ Video) and Security may reside in the same pathway as Telecommunications **ONLY** with prior approval through Owner. Physical separation shall be required when multiple applications other than telecommunications reside in the same tray. Design should be such that all requirements for a maximum 40% initial fill volume and a certified Category 6 and 6a structured cabling system will be met (i.e. bend radius, clearances and distances etc.). Minimum (2) supports per section of cable tray and attached to both sides shall be maintained throughout the entire system.

Cable tray to be sized so as not to exceed the allowable initial maximum fill volume of 40% for all services residing in the cable tray or support system. All metallic cable trays shall be grounded and clearly marked in accordance with ANSI/TIA/EIA-606-A and ANSI J-STD-607-B-2013.

27 05 28.39	Surface Raceways for Communications Systems
-------------	---

Surface raceway should only be considered as last resort and with prior coordination with Owner. Raceway design should be of a type that conforms to Category 6 and 6a certification for bend radius, interference and separation. Raceway must be capable of accepting the specified warranty solution's wiring products including jacks and faceplates. If electrical power and telecommunications services are both run in raceway separate compartments are required and must comply with applicable electrical codes. If a metallic barrier is provided, it must be bonded to ground. Raceway shall be sized so as not to exceed 40% initial fill rating.

All raceway shall be secured to surfaces via anchors of the appropriate type for the wall being attached to. Color of raceway shall match the wall being attached to.

27 05 28.40	Furniture Raceways and Pathways
-------------	---------------------------------

All furniture pathways to adhere to ANSI/TIA/EIA-569-C current standards. Maximum pathway fill shall be 40%. Minimum size pathway shall not force the cable into a bend radius less than 1" under condition of maximum fill. Any parallel pathway to electrical must have proper separation. All furniture pathways must be capable of accepting the approved warranty products brand termination hardware.

27 05 43	Underground Ducts and Raceways for Communication Systems
----------	--

Section
Number

Title

See Division 33 for site communications ducts and manholes. Under floor ducts systems shall be dedicated space for telecommunication cables and not shared with any other utility. The guideline for planning duct capacity is 1 in² of cross section for each 100 ft² of useable floor space. Junction boxes shall be placed at a maximum of 60 ft to allow access for cable placement. All distribution ducts must be physically linked to a telecommunication room directly or through no more than one feeder duct. Ducts entering the telecommunications room must terminate in either a slot or elbow.

Section
Number
27 10 00

Title
STRUCTURED CABLING

In order for Owner (ITS) to maintain ease of available stock, maintenance and administration, Belden systems will be installed.

Complete Belden ChannelMate solution for the structured cabling system to conform to all TIA/EIA Telecommunications Building Wiring Standards, latest edition of BICSI Telecommunications Method Manual and are covered by the ChannelMate System Performance Warranty shall be installed. A Belden Certified Installer will perform the telecommunications and AV structured cabling tasks.

Belden ChannelMate System Solution Warranty shall be required for all work performed on campus.

Berk-Tek Leviton may be used as a substitution of Belden when unavailable.

Structured Cabling color codes:

Application	Color
Voice	Yellow
Data	Blue
Wireless	Gray
Security,	Green
Card Reader,	Green
Attendance Reader	Green
CATV, A/V	White

Cooper B-Line Wire Management and Racking: (Black finish only unless otherwise specified)

19" Rack	SB556084XUFB
Vertical Management	SB86086D084FB (Used for the outside management in a multiple rack design)
	SB860810D084FB (Used in between racks in a multiple rack design)

(Vertical Management shall run the entire length of the rack)

(Doors, spools and hinges for a complete solution shall be included)

Horizontal Management	SB87019S1FB and SB87019S2FB
Ladder Rack	SB13AL12FB and SB13AL18FB
Elevation Kits	SB227R6FB
Radius Drops	SB13ALDO12FB and SB13ALDO18FB

Section
Number

Title

(All hardware kits for connectivity and support shall be included for a complete install)

Category 6 cabling is the minimum category cable for all communication designs and plenum in type.

For networks with higher bandwidth needs, Owner recommends a Category 6a structured cabling solution.

Star topology is required for all building layouts. Consult with Owner before following any format that is not a star topology for a building overview with recommendations.

27 11 00**Communications Equipment Room Fittings**

All buildings shall have at least one (depending on building size, footprint and design possibly more) telecommunications room per floor. Building design shall be such that no permanent link horizontal cable run exceeds 90 meters. Design should be that telecommunications rooms are as close to the core of the building as possible. Multiple story buildings shall stack the telecommunications rooms. A minimum of two 4"-conduits from each room to main Building Distribution Frame (BDF) is required. The space shall be dedicated to telecommunications equipment and not shared with electrical or any other building system. Equipment not related to the support of telecommunications closet (e.g., piping, ductwork, etc.) shall not be installed in, pass through, or enter the telecommunications room. Minimum size shall be 10'X12' with no ceiling. Wall finish shall be white in color. Lighting shall be a minimum of 500 lx measured 3ft. above finished floor. Room shall be environmentally controlled to maintain 72° F or lower 24/7. Flooring shall be static free, no carpeting. Power requirements are based on individual building design and need approval of Owner but a minimum of 2 120V quad convenience outlets are required. Each telecommunications room shall be equipped with a grounding bus bar connected to the building telecommunications main grounding busbar (TMGB). All walls shall be covered with 3/4" fire rated A-C plywood painted with (2) coats of white fire retardant paint on all (6) sides. Entrance door shall be minimum of 36" opening outward. Backbone and horizontal cable pathways shall terminate into room. Room cable management shall consist of ladder racks above all wall mount frames and all equipment racks.

Required BDF/ IDF Layout

Rack Mount 110 Blocks for CAT 3 or CAT 6 backbone cabling. Cable bundles to the patch panel shall be no greater than 24 cables.

All cable colors to be bundled separately in the ceiling and all closets. When cables enter the BDF/IDF they will be packed neatly (ie: cigarette packing).

Section Title
Number

Typical BDF/ IDF Rm. for VoIP Layout.
Cat3 OSP/ ISP Riser and Voice Panels (Yellow Cables) in the Left Rack.
Fiber/ Data Back Bone, WAPs and Data Panels (Blue Cables) in the Right Rack.
Ladder Racking within the Telco Rms shall be 18" wide
Layout is Diagrammatical only.

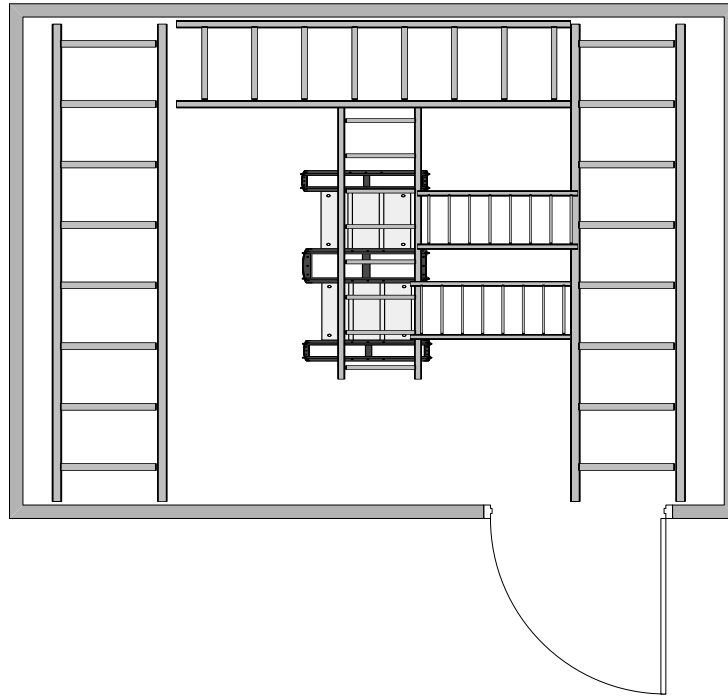

Typical BDF/ IDF Rm. for VoIP Layout.
Cat3 OSP/ ISP Riser and Voice Panels (Yellow Cables) in the Left Rack.
Fiber/ Data Back Bone, WAPs and Data Panels (Blue Cables) in the Right Rack.
Ladder Racking within the Telco Rms shall be 18" wide
Layout is Diagrammatical only.

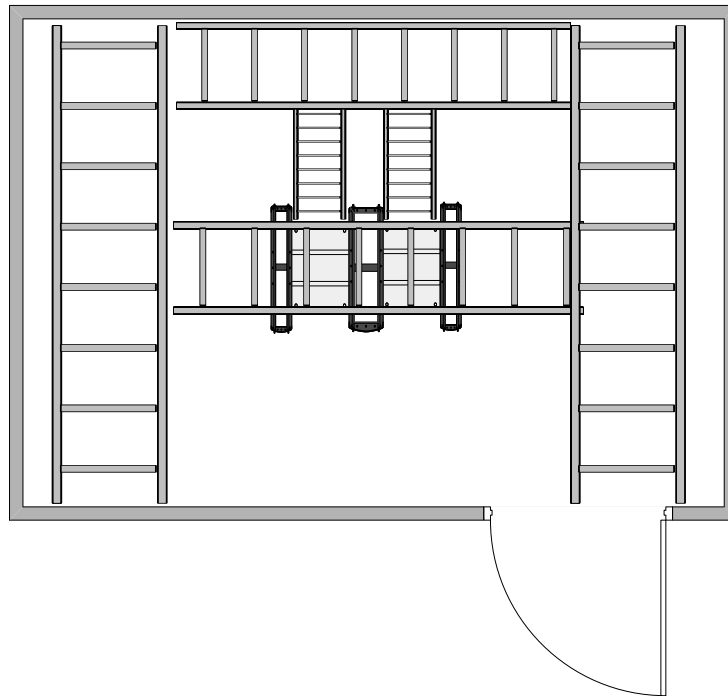

Section Number Title

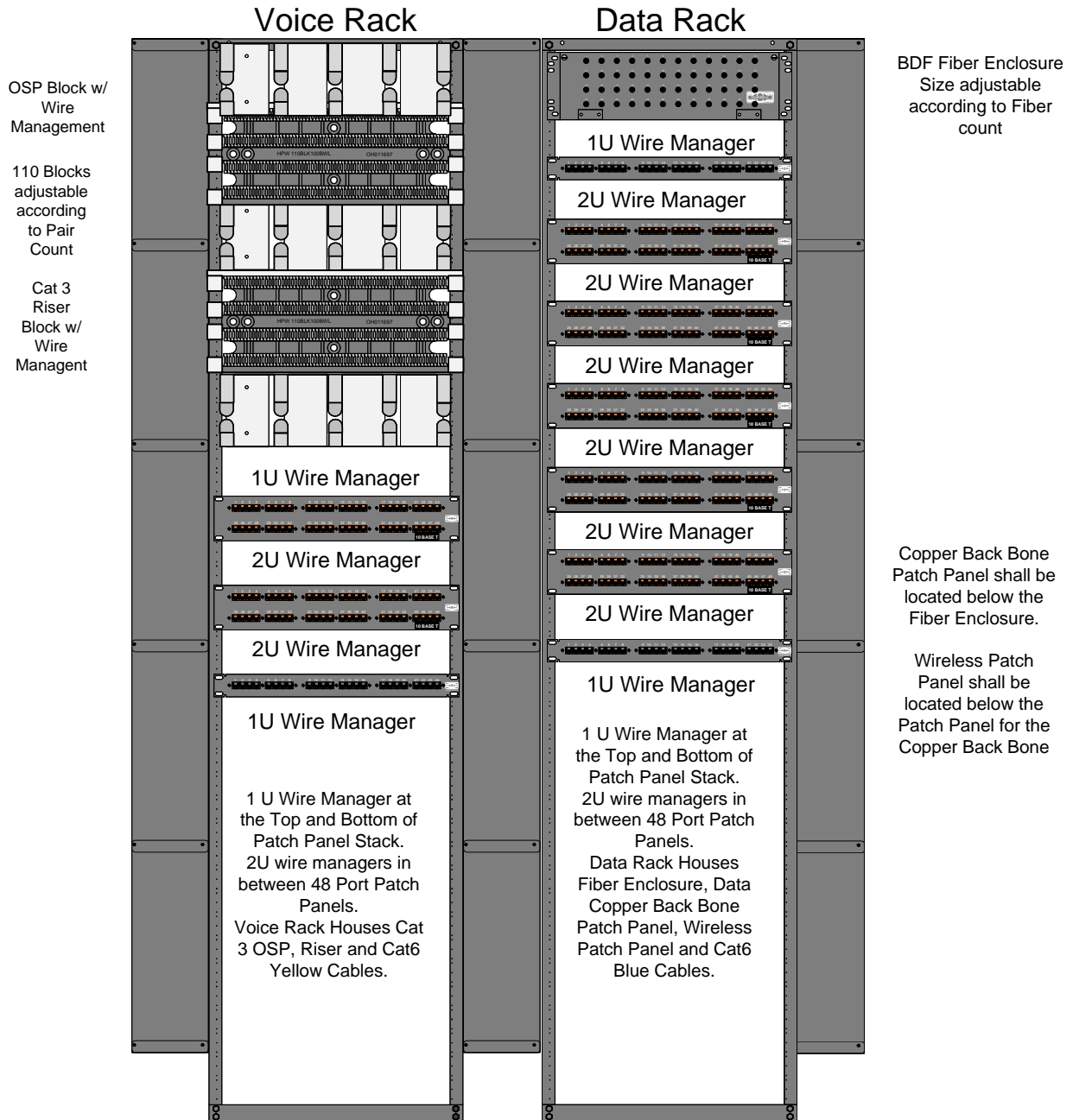

Typical BDF Rack Layout. Diagrams are for Layout Purposes only, Refer to Part Numbers related to warranty being installed
Bottom Wire Manager shall not drop below the #16 RU Marking. Space below this RU is reserved for Switches, Rack Mount Power Strips and UPS's. If Necessary install a Third rack for Network Equipment

Section Number Title

110 Blocks adjustable according to Pair Count

Cat 3 Riser Block w/ Wire Managent

Voice Rack

Data Rack

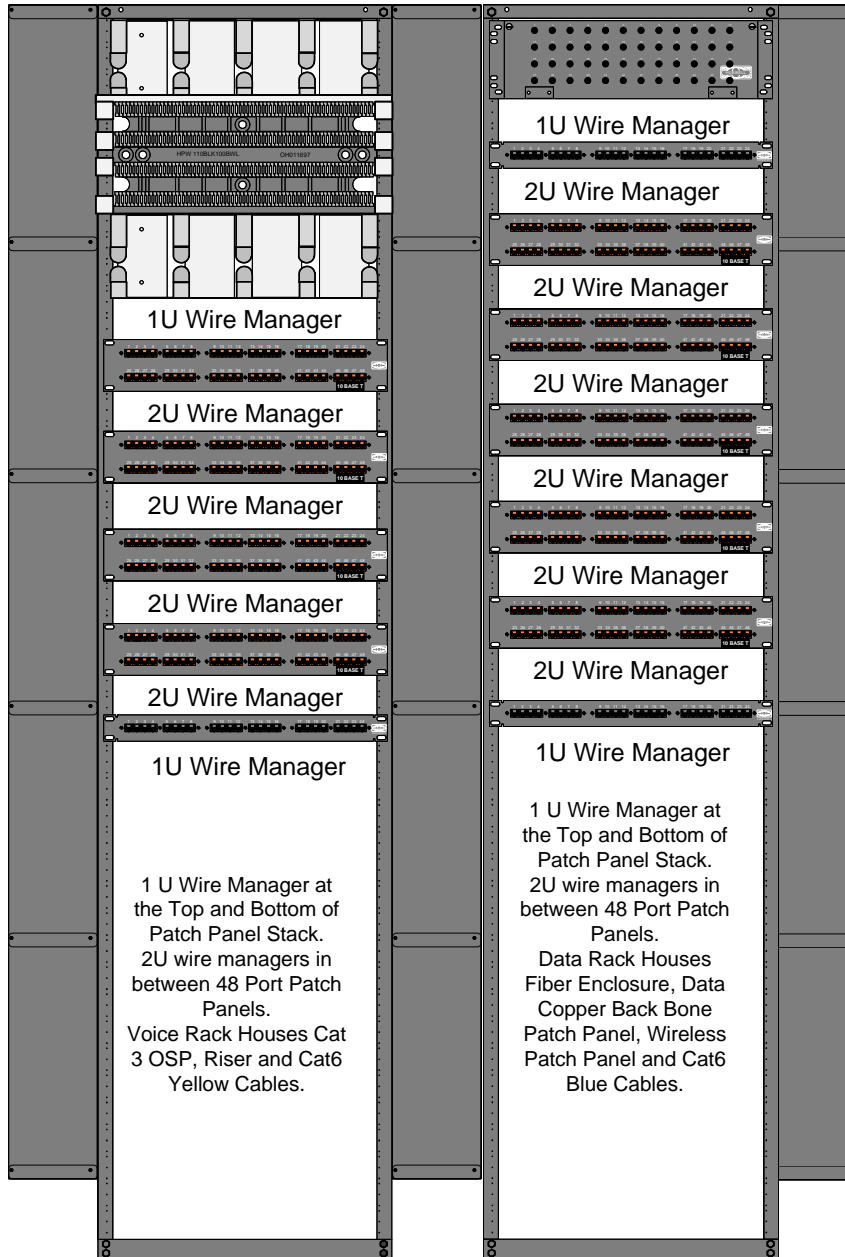

IDF Fiber Enclosure Size adjustable according to Fiber count

Copper Back Bone Patch Panel shall be located below the Fiber Enclosure.

Wireless Patch Panel shall be located below the Patch Panel for the Copper Back Bone

Typical IDF Layout. Diagrams are for Layout Purposes only, Refer to Part Numbers related to warranty being installed

Bottom Wire Manager shall not drop below the #16 RU Marking. Space below this RU is reserved for Switches, Rack Mount Power Strips and UPS's. If Necessary install a Third rack for Network Equipment

Section Number	Title
27 11 13	<p>Communications Entrance Protection</p> <p>All copper entrance cable to be terminated on a stub-in and stub-out building entrance terminal, (710 Splicing Only for Stubs In and Out) or a comparable substitute pre-approved by Owner. The Building Entrance Terminal (BET) requires protection by a gas tube type module, capable of handling surges higher than 300 volts, sneak currents and incorporates a positive temperature coefficient self-resetting current limiter as is UL497 listed.</p> <p>Circa 1900-100K series Stub In/ Out 100 pair BETs with covers recommended.</p> <p>Consult with Owner for recommendations and approval on B.E.T.'s.</p>
27 11 16	<p>Communications Cabinets, Racks, Frames, and Enclosures</p> <p>All network and telecommunication equipment will be housed in 7' 19" Black equipment racks, any other enclosure type requires pre-approval of Owner (NAU/ITS). Equipment rack shall meet ANSI/EIA-310-D standard. Rack secured and grounded per manufacturers and all applicable codes. Racks shall be positioned a minimum 4' from any wall in front of or behind it and minimum of 3" from the side of the rack to the wall. Rack equipped with horizontal cable management above and below all patch panels. Vertical cable management required on both sides of the rack and on all rack designs. Racks shall be equipped with rack mount 19" power strip 20A/120v with minimum of 8 NEMA5 -20R receptacles. Rack configuration requires pre- approval of Owner.</p>
27 11 19	<p>Communications Termination Blocks and Patch Panels</p> <p>All OSP twisted pair to be terminated on a stub-in and stub-out building entrance terminal with the stub in and out spliced with 710 modules. BET type must be pre-approved before installation.</p> <p>All Category 3 OSP cabling shall be terminated on BETs with stub in and stub out tails then transitioned to or directly terminated on Rack Mount 110 blocks. Category 6 and 6a cabling to terminate on the same category type patch panels. Any analog or dial tone services shall terminate on 110 blocks in the Telco closets. No 66 Blocks.</p>
27 11 23	<p>Communications Cable Management and Ladder Rack</p> <p>All cable management to conform to industry standards and comply with the specified warranty solution for fiber optic, Category 6 and 6a systems. All active and passive rack mount equipment to be separated by horizontal cable management. Vertical cable management required in all rack designs. Ladder rack required to all racks and for cable entrance into all telecommunication rooms (18" wide Ladder Rack in the BDF/ IDF's). All Category 3 OSP cable termination fields require transitioning to Rack Mount 110 blocks for a cross connect field with horizontal management above and below.</p>
27 11 26	<p>Communications Rack Mounted Power Protection and Power Strips</p>

Section
Number

Title

Minimum of one horizontal power strip 20A/120V with 8 NEMA5-20R receptacles.
Power cord length shall be a minimum 8' with NEMA5-20R plugs.

Section Number	Title
27 13 00	Communications Backbone Cabling
	See Division 33 82 00 for site communications distribution and outside plant requirements. All campus buildings will be fed with twisted pair copper, 8.3 micron single-mode fiber OS2, and 50 micron Laser optimized multi-mode fiber OM3. Number of conductors to be determined by Owner on a per project basis. 20' service loops shall be placed in all vaults, manholes and termination points. Minimum 48 strands of SM OS2 to each building. All fiber optic and copper communications backbone cabling shall be labeled every 25' throughout. Communication backbone cabling shall be labeled every 50' along its path excluding inside conduits.
27 13 13	Communications Copper Backbone Cabling
27 13 13.01	Intra Building Copper Backbone
	Building voice backbone cabling shall consist of Category 6 (4)pr cabling certified to Category 6 specification and be compliant for the building system performance warranty. All cable will be homerun and terminated at both ends on Rack Mount 110 blocks. All pairs tested for continuity, shorts grounds and wire map.
	Building Data backbone will consist of 8.3 micron single-mode fiber OS2, and 50 micron Laser optimized multi-mode fiber OM3 for data intra building backbone cabling. White Category 6 cables certified at Category 6 specifications and be compliant for system performance warranty specified for that job along.
27 13 13.02	Inter Building Copper Cable Backbone
	Copper cable shall be PE 39 type and meet the following requirements: <ul style="list-style-type: none"> • 24 AWG pair count determined by NAU/ITS per project • Cable shall meet the requirements of ANSI/CEA S-84-608. • Buried service wire to conform to ANSI/CEA S-86-634. • The transmission requirements of connecting hardware used in the OSP shall comply with the connecting hardware requirements of ANSI/TIA/EIA 568-A.
27 13 13.13	Communications Copper Cable Splicing
	All splicing and splice closures to conform to TIA/EIA-758 and be of the water tight and re-enterable type unless otherwise approved by Owner. All splicing shall be completed with 710 type multiple pair connectors only. No bridge-taps, and 25-pair binder groups shall not be split between termination points. All splices housed in a closure compatible with all materials used in the construction of cable, filling compounds, bonding and grounding devices, chemicals, and sealants that the closure would come in contact under normal conditions. Closure construction shall be reusable and re-enterable without factory refurbishing. All closures to be filled with filling compound. Replacement parts shall be readily available.

Section Number	Title
27 13 13.14	<p>Copper Cable Testing</p> <p>All Category 3 OSP twisted pair cable to be tested with complete wire map and 100 % pass rate for following:</p> <ul style="list-style-type: none"> • DC loop resistance • Wire map • Continuity to remote end • Shorts between two or more conductors • Crossed pairs • Reversed pairs • Split pairs • Any other miss-wiring <p>All Voice and Data Category 6 and 6a twisted pair cables will be tested with a 100% pass rate to the cable categories applicable standard for the following in accordance to Amendment 10 of the TIA/EIA-568-B.2 document:</p> <ul style="list-style-type: none"> • Insertion Loss (IL) • Near End Crosstalk (NEXT) • Power Sum Near End Crosstalk (PSNEXT) • Attenuation to Crosstalk Ratio (ACR) • Power Sum Attenuation to crosstalk Ratio (PSACR) • Far End Crosstalk (FEXT) • Equal Level Far End Crosstalk (ELFEXT) • Power Sum Equal Level Far End Crosstalk (PSELFEXT) • Return Loss (RL) • Wire Map • Propagation Delay • Delay Skew • Length
27 13 23	<p>Communications Optical Fiber Backbone Cabling</p> <p>Fiber Optic cabling system shall be Belden.</p> <p>Fiber- SM</p> <p>Maximum fusion splice loss shall be no greater than .03db. A germania-doped silica core surrounded by a concentric silica glass cladding shall comprise each optical fiber. The fiber shall be a matched clad design manufactured by the outside vapor deposition process (OVD). Each optical fiber refractive index profile shall be step index.</p> <p>Each fiber shall be proof tested by the fiber manufacturer at a minimum of 100 kpsi (0.7 GN/m²). The fiber shall be coated with a dual acrylate protective coating and the coating shall be in physical contact with the cladding surface. The single-mode</p>

Section
Number

Title

fiber shall meet EIA/TIA-492CAAB, "Detail Specification for Class IVa Dispersion-Unshifted Single-Mode Optical Fibers with Low Water Peak," and ITU-T G.652.C, "Characteristics of Single-Mode Optical Fiber Cable." Fiber shall have a mode field diameter of $9.20 \pm 0.40 \mu\text{m}$ at 1310 nm and $10.40 \pm 0.50 \mu\text{m}$ at 1550 nm. Fiber core-clad concentricity shall be $\leq 0.5 \mu\text{m}$. Fiber cladding diameter shall be $125.0 \pm 0.7 \mu\text{m}$. Fiber cladding non-circularity shall be $\leq 0.7\%$. Fiber coating diameter shall be $245 \pm 5 \mu\text{m}$.

The attenuation specification shall be a maximum value for each cabled fiber at $23 \pm 5^\circ\text{C}$ on the original shipping reel. The cabled fiber attenuation for Loose Tube and Ribbon cable constructions shall be $< 0.4 \text{ dB/km}$ at 1310 nm and $< 0.3 \text{ dB/km}$ at 1550 nm. For tight buffered constructions the cabled fiber attenuation shall be $< 1.0 \text{ dB/km}$ at 1310 nm and $< 0.75 \text{ dB/km}$ at 1550 nm. The attenuation at the water peak (1383 nm) shall not exceed the 1310 nm attenuation value. The cabled fiber shall be capable of operating in the 1360 nm to 1480 nm water peak region.

The attenuation due to 100 turns of fiber around a $50 \pm 2 \text{ mm}$ diameter mandrel shall not exceed 0.05 dB at 1310 nm and 0.10 dB at 1550 nm. The attenuation due to 100 turns of fiber around a $75 \pm 2 \text{ mm}$ diameter mandrel shall not exceed 0.10 dB at 1625 nm. There shall be no point discontinuities greater than 0.10 dB at 1310 nm and 1550 nm.

The maximum dispersion shall be $\leq 3.2 \text{ ps}/(\text{nm}\cdot\text{km})$ from 1285 nm to 1330 nm and shall be $\leq 18 \text{ ps}/(\text{nm}\cdot\text{km})$ at 1550 nm. The cabled fiber shall support Gigabit Ethernet (GbE) operation according to the 1000BASE-LX (1310 nm) specifications up to 5000 m in accordance with the GbE standard. The cabled fiber shall support laser-based 10 Gigabit Ethernet (10GbE) operation according to the 10GBASE-LX4 (1300 nm region), 10GBASE-L (1310 nm) and 10GBASE-E (1550 nm) specifications for distances of 10 km, 10 km and 40 km, respectively.

The cabled optical fiber shall support industry-standard multi-gigabit fiber channel physical interface specifications.

Fiber MM 50um Laser Optimized OM3

Each fiber in the cable must be usable and meet required specifications. Each optical fiber shall be sufficiently free of surface imperfections and inclusions to meet the optical, mechanical and environmental requirements of this specification. A germania-doped silica core surrounded by a concentric silica glass cladding shall comprise each optical fiber. The fiber shall be a matched clad design manufactured by the outside vapor deposition process (OVD). Each optical fiber shall be proof tested by the fiber manufacturer at a minimum of 100 kpsi (0.7 GN/m^2). The fiber shall be coated with a dual-layer acrylate protective coating. The coating shall be in physical contact with the cladding surface. The attenuation specification shall be a maximum value for each cabled fiber at $23 \pm 5^\circ\text{C}$ on the original shipping reel. The

Section Number	Title
	<p>multimode fiber shall meet TIA-492AAAC, "Detail Specification for 850-nm Laser-Optimized, 50-μm Core Diameter/125-μm Cladding Diameter Class Ia Graded-Index Multimode Optical Fibers."</p> <p>The core diameter shall be $50.0 \pm 2.5 \mu\text{m}$. The cladding diameter shall be $125.0 \pm 2.0 \mu\text{m}$. The cladding non-circularity shall be = 1.0%. The core-clad concentricity shall be = $1.5 \mu\text{m}$. The coating diameter shall be $245 \pm 5 \mu\text{m}$. The optical fiber refractive index profile shall be graded. The numerical aperture of the fiber shall be 0.200 ± 0.015.</p> <p>The maximum cabled fiber attenuation shall be 3.0 dB/km at 850 nm and 1.0 dB/km at 1300 nm for all cable types. The cabled optical fiber shall have a minimum effective modal bandwidth (EMB) of 2000 MHz•km at 850 nm in accordance with FOTP-220 for 10 Gigabit Ethernet. The cabled optical fiber shall have a minimum over-filled launch (OFL) bandwidth of 1500/600 MHz•km at 850/1300 nm. The cabled optical fiber shall have a minimum restricted mode launch (RML) bandwidth of 1400 MHz•km at 850 nm in accordance with FOTP-204 for Gigabit Ethernet.</p> <p>The cabled optical fiber shall support industry-standard IEEE 802.3 10GBASE-S (10 Gigabit Ethernet at 850 nm) physical layer specifications for 300 m. The cabled optical fiber shall support industry-standard IEEE 802.3 1000BASE-SX (Gigabit Ethernet at 850 nm) physical layer specifications for 1000 m and 1000BASE-LX (Gigabit Ethernet at 1300 nm) for 600 m. The cabled optical fiber shall support industry-standard multi-gigabit Fibre Channel physical interface specifications.</p> <p>There shall be no point discontinuity greater than 0.2 dB. The attenuation coefficient at 1380 nm shall not exceed the attenuation coefficient at 1300 nm by more than 3.0 dB/km. The attenuation due to 100 turns of fiber around a 75 mm diameter mandrel shall not exceed 0.5 dB at 850 nm and 1300 nm.</p>
27 13 23.01	<p>Building Optical Fiber Cable Backbone</p> <p>Single-Mode OS2 and 50 Micron Laser optimized Multi-mode OM3 fiber optic backbone required between BDF and all IDF locations. All cable to be homerun with no splices and installed in a 1" plenum or riser rated (depending on the application) suitable inner duct unless armored type is used. Strand count to be determined by Owner on a per project basis. 48 Strands of SM OS2 Minimum to each building.</p> <p>ISP Cable- MIC 2-24 fibers plenum</p> <p>Cable shall be plenum-rated, all-dielectric, with two to twenty-four $900 \pm 50 \mu\text{m}$ tight-buffered fibers. Owner has pre-approved the following product to be in compliance with these standards: TBII® Tight-Buffered Fiber shall be made of a PVC material and shall have a UV-cured acrylate coating (low-friction slip layer) between the acrylate coating of the optical fiber and the PVC buffer.</p>

Section
Number

Title

The fiber coating, low-friction slip layer and PVC buffer shall be removable with commercially available stripping tools in a single pass for termination or splicing. The individual fibers shall be color-coded for identification. The optical fiber color coding shall be in accordance with TIA/EIA-598-B, "Optical Fiber Cable Color Coding." Fibers shall be stranded together around jacketed or non-jacketed dielectric strength members via reverse oscillation and surrounded with dielectric strength members and a ripcord. Cables containing 12 to 24 fibers shall have a dual-layer stranded design. The cable jacket color shall be orange for cables containing all multimode fiber, except for cables containing 50/125 μm , 850 nm laser optimized fiber, which shall have an aqua colored outer jacket. The cable jacket color shall be yellow for cables containing all single mode fiber. Cable shall have a storage temperature range of -40° to 70°C on the original shipping reel, installation temperature range of 0° to 60°C , and an operating temperature range of 0° to 70°C . Cable manufacturer shall be ISO 9001 registered.

ISP Cable- UMIC 24-144 fibers plenum

Cable shall be all-dielectric and contain 36 to 144 $900 \pm 50 \mu\text{m}$ tight-buffered fibers. TBII® Tight-Buffered Fiber shall be made of a PVC material and shall have a UV-cured acrylate coating (low friction slip layer) between the acrylate coating of the optical fiber and the PVC buffer. The fiber coating, low friction slip layer and PVC buffer shall be removable with commercially available stripping tools in a single pass for termination or splicing. The individual fibers shall be color-coded for identification. The optical fiber color coding shall be in accordance with TIA/EIA-598-B, "Optical Fiber Cable Color Coding." Fibers shall be stranded via reverse oscillation with dielectric strength members and a ripcord in either 6-fiber or 12 fiber subunits. Cable with < 60 fibers shall contain 6-fiber subunits, otherwise cable shall contain 12-fiber subunits. Subunits shall be stranded together in a planetary configuration around a jacketed or bare glass reinforced plastic (GRP) dielectric central member. Cable shall contain a ripcord underneath outer cable jacket to facilitate jacket removal. Each subunit jacket shall be made of a PVC material and shall be identified with a unique number at periodic intervals. Subunit color containing multimode fiber shall be orange. Subunit color containing 50/125 μm , 850 nm laser optimized fiber shall be aqua. Subunit color containing single-mode fiber shall be yellow. A dual-layer subunit design shall be used for cables containing 108 to 144 fibers. The cable jacket color shall be orange for cables containing all multimode fiber, except for cables containing 50/125 μm , 850 nm laser optimized fiber, which shall have an aqua colored outer jacket. The cable jacket color shall be yellow for cables containing all single mode fiber. Hybrid cables (containing more than one type of fiber) shall have an outer jacket with the color corresponding to the greatest percentage of total fibers within the cable, except for hybrid cables containing 50/125 μm , 850 nm laser optimized fiber, which shall have an aqua colored outer jacket. Cable shall be listed OFNP/FT-6 and be fully compliant with ICEA S-83-596. Cable outer jacket shall be marked with the manufacturer's name or ETL file number, date of manufacture, fiber count, fiber type, flame rating, listing symbol,

Section Number	Title
	<p>and sequential length markings every two feet (e.g., "NAME BRAND CABLE - 01/00 – 72 SM– TB2 - OFNP (ETL) OFN FT6 (CSA) 0001 FEET"). The marking shall be in contrasting color to the cable jacket.</p> <p>Cable shall have a storage temperature range of -40°C to +70°C, installation temperature range of 0°C to +60°C, and an operating temperature range of 0°C to +70°C. Cable manufacturer shall be ISO 9001 registered.</p>
27 13 23.02	<p>Inter Building Optical Fiber Cable</p> <p>Fiber Optic cable shall meet following requirements:</p> <p>Cable shall be all-dielectric, stranded loose-tube design with dry water blocking for outdoor duct and aerial installations in fiber counts from two to 288. Each fiber shall be distinguishable by means of color-coding in accordance with TIA/EIA-598-B, "Optical Fiber Cable Color Coding." The fibers shall be colored with ultraviolet (UV) curable inks. Buffer tubes shall be made from polypropylene. Each buffer tube shall contain a water swellable yarn for water blocking protection. The water-swellable yarn shall be non-nutritive to fungus, electrically non-conductive, and homogeneous. It shall also be free from dirt or foreign matter. This yarn will preclude the need for other water blocking material; the buffer tube shall be gel free. The optical fibers shall not require cleaning before placement into a splice tray or fan out kit. The buffer tube shall be manufactured to a standard 3.0 mm in size, regardless of fiber count, to reduce the number of required installation and termination tools. Buffer tubes containing fibers shall be color coded with distinct and recognizable colors in accordance with TIA/EIA-598-B. Buffer tube colored stripes shall be inlaid in the tube by means of co extrusion when required. The nominal stripe width shall be 1 mm. Buffer tubes in a hybrid cable (cable containing more than one type of fiber) shall contain only one fiber type. Identification of fiber types in a hybrid cable shall correspond to fiber core diameter (or mode field diameter) from smallest to largest in accordance with TIA/EIA-598-B. Buffer tubes shall be stranded around the dielectric central member using the reverse oscillation stranding process. Two polyester yarn binders shall be applied contra helically with sufficient tension to secure each buffer tube layer to the dielectric central member without crushing the buffer tubes. The binders shall be non-hygroscopic, non-wicking, and dielectric with low shrinkage. Water swellable yarn(s) shall be applied longitudinally along the central member during stranding. For dual-layer cables, a second (outer) layer of buffer tubes shall be stranded over the original core to form a two-layer core. A water swellable tape shall be applied longitudinally over both the inner and outer layer. The water-swellable tape shall be non-nutritive to fungus, electrically non-conductive, and homogenous. It shall also be free from dirt and foreign matter. Cable shall be comprised of water-swellable yarns and/or tapes, dielectric strength members (as required), ripcord(s) and an MDPE jacket containing carbon black to provide ultraviolet light protection while inhibiting the growth of fungus. Cable jacket shall be marked with the manufacturer's name, month and year of manufacture, sequential meter or foot markings, a telecommunication</p>

Section Number	Title
27 13 23.13	<p>handset symbol as required by Section 350G of the National Electrical Safety Code® (NESC®), fiber count, and fiber type. The actual length of the cable shall be within -0/+1% of the length markings. The print color shall be white, with the exception that cable jackets containing one or more coextruded white stripes, which shall be printed in light blue. The height of the marking shall be approximately 2.5 mm. Cable shall contain reverse oscillation lay (ROL) markings as needed. Cable shall have a storage temperature range of -40° to 70°C, an installation temperature range of -30 to 70°C, and an operating temperature range of -40° to 70°C. Cable shall have a short-term tensile rating of 2700 N. No fiber strain shall occur over the service life of the cable when subjected to a maximum, long-term tensile rating of 890 N. Cable shall meet the functional requirements of Rural Utilities Service (RUS) 7 CFR 1755.900 and be fully compliant with ICEA S-87-640. Manufacturer shall be ISO 9001 and TL 9000 registered.</p>

27 13 23.13 Optical Fiber Splicing and Terminations and Testing

Rack mount Housings:

Housing shall be of the same specified warranty as the structured cabling provided. Housings shall be mountable in an EIA-310 compatible 465- or 592 mm rack. Housings shall be available in both 1U ,2U and 4U sizes. One EIA rack space or panel height (denoted as 1U) is defined as being 44.45 mm in height. The unit shall meet all applicable design requirements listed in ANSI/TIA/EIA-568, ANSI/TIA/EIA-942, and the polymer compounds flammability requirements of UL 94 V-0. Manufacturer shall be ISO 9001 and TL 9000 registered. Housings shall be manufactured using 16-gauge aluminum or equivalent for structural integrity and shall be finished with a black powder coat for durability. All joints shall be welded and finished in a workman-like manner. Installation fasteners shall be included and shall match the housing color. The unit shall include a cable clamping mechanism to provide cable strain-relief.

The front and rear doors shall be lockable when used with an optional key lock kit. The connector housings shall have a labeling scheme that complies with ANSI/TIA/EIA-606. The housings shall be available with factory-installed connectorized cable stubs in multiple cable and connector types. The housing shall have the ability to accommodate fusion splicing with additional hardware. The housing shall be 16 inches deep for extra cable routing.

All fiber optic terminations/splices shall be fusion spliced.

Connectors LC SM

Connector shall be compliant with industry standard ANSI/TIA/EIA-568-B.3. The connector shall comply with the TIA/EIA Fiber Optic Connector Inter-mate ability Standard (FOCIS) document, TIA/EIA-604-2. The connector installation shall not require the use of epoxies, adhesives or ovens. The connector shall be installable

Section
Number

Title

upon 900 μm buffered fiber in one minute or less and upon 2.9 mm jacketed cable in three minutes or less total time. The connector shall be installable upon single-mode optical fiber. Ferrule material shall be ceramic. Connector shall be consistently capable of insertion losses of 0.3 dB (typical) and shall be 0.75 dB (maximum) when installed in accordance with the manufacturer's recommended procedure and tested in accordance with FOTP-171. Connector reflectance shall be measured after manufacture to be less than or equal to -40/-55 dB ultra physical contact (UPC). Manufacturer shall be ISO 9001 and TL 9000 registered. The manufacturer shall have an in-depth knowledge, and more than 10-year history, of manufacturing and supporting connector technology that does not require epoxy or polishing in the field.

Connectors LC MM 50um

Connector shall be compliant with industry standard ANSI/TIA/EIA-568-B.3. The connector shall comply with TIA/EIA Fiber Optic Connector Inter-mate ability Standard (FOCIS) document, TIA/EIA-604-2. The connector installation shall not require the use of epoxies, adhesives or ovens. The connector shall be installable upon 900 μm buffered fiber in one minute or less and upon 2.9 mm jacketed cable in three minutes or less total time. The connector shall be installable upon 50/125 μm multimode optical fiber. Ferrule material shall be ceramic. The connector crimp on mechanism shall protect the bare fiber from the ingress of air or waterborne contaminants. Connector shall be consistently capable of insertion losses of 0.3 dB (typical) and shall be 0.75 dB (maximum) when installed in accordance with the manufacturer's recommended procedure and tested in accordance with FOTP-171. Connector reflectance shall be less than or equal to -20 dB. Manufacturer shall be ISO 9001 and TL 9000 registered.

Connectors LC MM 50um Laser Optimized OM3

Connector shall be compliant with industry standard ANSI/TIA/EIA-568-B.3. The connector shall comply with TIA/EIA Fiber Optic Connector Inter-mate ability Standard (FOCIS) document, TIA/EIA-604-2. The connector installation shall not require the use of epoxies, adhesives or ovens. The connector shall be installable upon 900 μm buffered fiber in one minute or less and upon 2.9 mm jacketed cable in three minutes or less total time. The connector shall be installable upon 850-nm laser-optimized 50 μm multimode optical fiber. Ferrule material shall be ceramic. The connector crimp on mechanism shall protect the bare fiber from the ingress of air or waterborne contaminants. Connector shall be consistently capable of insertion losses of 0.3 dB (typical) and shall be 0.75 dB (maximum) when installed in accordance with the manufacturer's recommended procedure and tested in accordance with FOTP-171. Connector reflectance shall be less than or equal to -20 dB. Manufacturer shall be ISO 9001 and TL 9000 registered.

Splice cases:

Section Number	Title
	<p>The fiber splice enclosures shall be available in canister (butt) and in-line styles to fit most applications. All end-caps feature two express ports for uncut feeder cables.</p> <p>Splice case shall be resistant to solvents, stress cracking and creep. The housing materials shall also be compatible with chemicals and other materials to which they might be exposed in normal applications. The optical fiber closure shall be capable of accepting any optical fiber cable commonly used in interoffice, outside plant and building entrance facilities. As an option, the ability to double the cable capacity of an installed canister splice closure by use of a kit shall be available. Such a conversion shall not disturb existing cables or splices.</p> <p>Encapsulation shall not be required to resist water penetration. The splice closure shall be re-enterable. The closure end-cap shall be capable of accepting additional cables without removal of the sheath retention or strength-member-clamping hardware on previously installed cables or disturbing existing splices. The optical fiber splice closure shall provide a clamping mechanism to prevent pistoning of the central member or strength members and to prevent cable sheath slip or pullout. The splice closure shall have appropriate hardware and installation procedures to facilitate the bonding and grounding of metal components in the closure and the armored cable sheath. The cable bonding hardware shall be able to accommodate a copper conductor equal to or larger than 6 AWG.</p> <p>Aerial splice closures shall have available the necessary hardware to attach and secure the closure to an aerial strand. The closure shall accommodate splice trays suitable for single-fiber, single fiber heat-shrink, mechanical or ribbon heat-shrink splices. The small splice closure shall accommodate up to 72 single-fiber splices or 144 ribbon fiber splices using 12-fiber ribbons. The medium-sized closure shall accommodate up to 288 single-fiber splices or 432 ribbon-fiber splices. The large closure shall accommodate up to 480 single-fiber splices or 864 ribbon-fiber splices. The installation of the splice closure shall not require specialized tools or equipment, other than those normally carried by installation crews.</p> <p>All fibers (inter and intra building) tested for continuity and tagged at both ends with building number and ID number. All fibers tested for insertion loss, both directions, at 850nm and 1350nm on multi-mode, and at 1310nm and 1550nm on single-mode bi-directionally. All results documented and provided electronically. OTDR signature trace documents on all fibers with pertinent points documented (splice, endpoints, etc.) Only test results with Owner (ITS) personnel present will be accepted.</p>

Section Number	Title
27 15 00	Communications Horizontal Cabling
27 15 01	Communications Horizontal Cabling Applications
27 15 01.16	Voice Communications Horizontal Cabling All work stations shall be fed by one (1) 4-pair 100 ohm balanced Category 6 plenum rated with yellow jacket cable with matching color jacks. No horizontal permanent link cable run shall exceed 90 meters. Cable shall be terminated at the work station on one (1) Category 6 yellow jack capable of Gigabit Ethernet (GbE). All Voice jacks should have Gigabit Ethernet (GbE) capability. All Terminations shall be 568-A. All work stations shall consist of one (1) yellow Cat6 and one (1) blue Cat6 cables with matching color jacks. All cable colors to be bundled separately in the ceiling and all closets. When cables enter the closets they will be packed neatly (i.e. cigarette packing).
27 15 01.19	Data Communications Horizontal Cabling All work stations shall be fed by one (1) 4-pair 100 ohm balanced Category 6 plenum rated with blue jacket cable with matching color jack. Manufacturer of cable must be accepted by the proposed warranty. No horizontal cable run shall exceed 90 meters. Cable shall be terminated at workstation on Category 6 jack and terminated at the BDF/IDF on Category 6 patch panel. All cables tested and certified to Category 6 standard. All data jacks should have a Gigabit Ethernet (GbE) capability. Computer labs, classrooms, and all other special applications require the input of Owner on number and location of drops. Only Velcro type cable ties shall be used with Category 6 and 6a cabling. All Terminations shall be 568-A. All work stations shall consist of one (1) yellow Cat6 and one (1) blue Cat6 cable with matching color jacks. All cable colors to be bundled separately in the ceiling and all closets. When cables enter the closets they will be packed neatly (i.e. cigarette packing).
27 15 01.20	Wireless Data Communication Horizontal Cabling Owner's wireless solution is Cisco 3602I or 3602E w/ external antennae (Cisco Aironet 2.4-GHz/5-GHz MIMO 4-Element Patch Antenna (AIR-ANT2566P4W-R)) 802.11n access points utilizing WISM 2 Controllers. Horizontal cabling shall be designed to meet minimum -67db signal strength in all areas. This is generally achieved with AP locations placement at a 35' radius. Wireless design should be completed using the planning mode of the Cisco Prime Infrastructure (PI) or other comparable software to generate the locations that meet these parameters as well as any user requirements such as increased client density loads found in classroom and large capacity spaces.

Section Number	Title
	<p>WAP locations should be located so that horizontal mounting will be allowed. All WAP locations shall consist of (2) Category 6a gray cables with matching color jacks. No permanent link run shall exceed 80 meters (242') including the 30' service loop at the device end. All installations shall be installed in accordance to current TIA TSB-162-A. Wireless Cables shall be terminated 568-A on Cat6a Patch Panels separate from the station cable Patch Panels. All wireless cabling shall terminate in the BDF unless distance is an issue. Telecommunications installing contractor is responsible for the mounting of all WAPs and station side patching on all installations.</p>
27 15 43	<p>Communications Faceplates and Connectors</p> <p>Consult with Owner for specified port openings per faceplate. Workstation locations fed by two (2) Category 6 4-pair cables. (color and material of the face plate to be determined by Owner) with two (2) Category 6 modular jacks and one blank with matching color to the face plate if necessary. (Category 6 and Category 6a cables and jacks terminated T568A).</p> <p>Owner recommended faceplate is white with modular jack colors matching the cable jacket colors. All work stations shall consist of one (1) yellow Cat6 and one (1) blue Cat6 cable with matching color jacks terminated 568-A.</p>

Section Title
Number

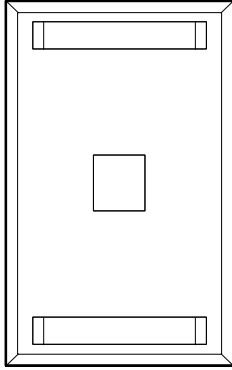

1 Port Jack Color Layout
Yellow

All workstations shall consist of:
(1) Double Gang Outlet box with Reducing Cover/ No Reducing Cover for double gang face plates

(1) Yellow Cat6 Jack

(1) Blue Cat6 Jack

All data only locations shall have the colors split (eg: 2 data only shall consist of one yellow and one blue cables and jacks
4 data only shall consist of 2 yellow and 2 blue cables and jacks)

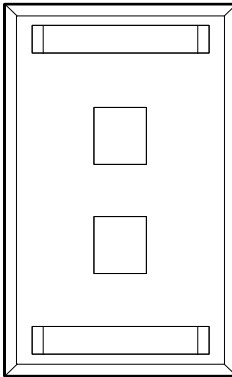

2 Port Jack Color Layout
Yellow
Blue

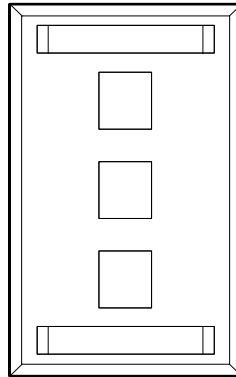

3 Port Jack Color Layout
Yellow
Blue
Blank

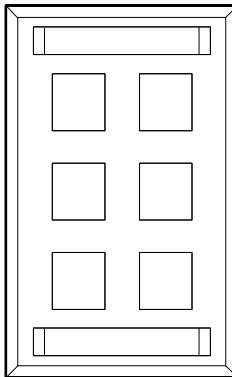

6 Port FP Jack Color Layout
Station 1 Station 2
Yellow Blue
Yellow Blue
Yellow Blue

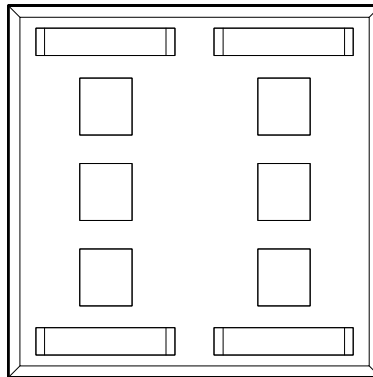

Section Number	Title
27 16 00	Communications Connecting Cords, Devices, and Adapters
27 16 13	Communications Custom Cable Assemblies All custom-built cable assemblies shall be tested and certified to appropriate category level and meet performance level of all applicable codes and standards.
27 16 16	Communications Media Converters, Adapters, and Transceivers Furnished by Owner.
27 16 19	Communications Patch Cords, Stations Cords, and Cross Connect Wire Patch cords, equipment cords, and work area cords must be manufactured by the approved warranty provider and meet the applicable performance requirements in ANSI/TIA/EIA-568-B.2. All cords associated with the data horizontal cable system must be 4-pair Category 6 or Category 6a rated, factory terminated, meet horizontal cable specifications and shall be included in the System Warranty. All patch cords sized to provide a neat appearance. Patch cord colors shall match the designated application it is being used for.

Section Number	Title
27 20 00	DATA COMMUNICATIONS
27 21 00	Data Communications Network Equipment All Data Communication Equipment furnished by Owner.

Section Number	Title
27 30 00	VOICE COMMUNICATIONS SWITCHING AND ROUTING EQUIPMENT
27 31 00	Voice Communications Switching and Routing Equipment All equipment furnished by Owner.
27 32 00	Voice Communications Telephone Sets, Facsimiles, and Modems All telephone sets and ancillary equipment furnished by Owner except elevator and emergency telephones.
27 32 23	Elevator Telephones All models shall be all-campus alert (ACA) capable and must be pre-approved by Owner (ITS). All site located emergency phones to be fed by a minimum (1) 1" conduit suited for its environment and (1) Category 6 rated cable suited for its environment with station protection and routed to the closest equipment room. Enclosure shall have electrical ground installed within 20 feet and the use of a gas discharge type lightning arrestor is required. The response time should be 1ns or less. If additional surge protection is needed, Surge Arrestor, Pt 800-1018 is required. Housing associated with elevator phones shall be grounded. Owner has pre-approved the following manufacturer to be in compliance with these standards: Ramtel.
27 32 26	Ring-Down Emergency Telephones All models shall be all-campus alert (ACA) capable and must be pre-approved by Owner (ITS). All site located emergency phones to be fed a minimum (1) 1" conduit suited for its environment and (1) Category 6 rated cable suited for its environment with station protection and routed to the closest telecommunications equipment room. Enclosure and columns shall have electrical ground installed within 20 feet and the use of a gas discharge type lightning arrestor is required. The response time should be 1ns or less. If additional surge protection is required, Surge Arrestor, Pt 800-1018 is required. Owner has pre-approved the following manufacturer to be in compliance with these standards: Ramtel.
27 33 00	Voice Communications Messaging All services provided and maintained by Owner.
27 34 00	Call Accounting All services provided and maintained by Owner.
27 35 00	Call Management All services provided and maintained by Owner.
27 40 00	AUDIO-VIDEO COMMUNICATIONS All services provided and maintained by Owner.

Section
Number

Title

All AV installations and services shall be designed and installed in accordance to Division 27. See Design Guidelines for additional information on classroom standards.

Section Number	Title
28 00 00	ELECTRONIC SAFETY AND SECURITY
28 01 00	Operation and Maintenance of Electronic Safety and Security
28 01 10	Operation and Maintenance of Electronic Access Control Systems
28 01 20	Operation and Maintenance of Electronic Surveillance
28 05 00	Common Work Results for Electronic Safety and Security
28 05 13	Conductors and Cables for Electronic Safety and Security
28 05 13.16	Access Control Communication Conductors and Cable (Non-IP Based)
28 05 26	Grounding and Bonding for Electronic Safety and Security
28 05 28	Pathways for Electronic Safety and Security
28 05 28.13	Terminations, Splices, and Connections
28 05 28.29	Hangers and Support for Electronic Access and Security
28 05 28.33	Conduits and Backboxes for Electronic Safety and Security
28 05 53	Identification for Electronic Safety and Security
28 06 00	Schedules for Electronic Safety and Security
28 06 10	Schedules for Electronic Access Control System
28 06 20	Schedules for Electronic Surveillance
28 08 00	Commissioning of Electronic Safety and Security
28 08 10	Commissioning of Electronic Safety and Security
28 08 10	Commissioning of Electronic Access Control Systems
28 08 20	Commissioning of Electronic Surveillance
28 10 00	ELECTRONIC ACCESS CONTROL AND INTRUSION DETECTION
28 13 00	Access Control
28 13 01	Access Control System Installation
28 13 13	Access Control Global Applications
28 13 16	Access Control Systems and Database Management
28 13 19	Access Control Systems Infrastructure
28 13 26	Access Control Remote Devices
28 13 43	Access Control Identification Management System
28 16 00	Intrusion Detection
28 20 00	ELECTRONIC SURVEILLANCE
28 23 00	Video Surveillance System
28 23 01	Video Surveillance System Installation
28 23 13	Video Surveillance Control and Management System

DIVISION 28 – ELECTRONIC SAFETY & SECURITY

Section Number	Title
28 23 19	Digital Video Recording Devices
28 23 23	Video Surveillance Systems Infrastructure
28 23 29	Video Surveillance Remote Devices and Sensors
28 26 00	Electronic Personal Protection System
28 30 00	ELECTRONIC DETECTION AND ALARM
28 31 00	Fire Detection and Alarm

Section Number	Title
28 00 00	ELECTRONIC SAFETY AND SECURITY
28 01 00	Operation and Maintenance of Electronic Safety and Security

PART 1 – GENERAL

The operation, oversight and maintenance of all Electronic Access Control and Intrusion Detection Systems, herein referred to as Northern Arizona University’s Physical Access Security System (NAUPASS), is a shared responsibility of the following department/offices:

- 1.) Campus Services and Activities IT
- 2.) Facility Services Building Access Services
- 3.) Facility Services Planning, Design and Construction
- 4.) Northern Arizona University Police Department

Individual departments and offices within the University may have access to discreet or combined segments; however, responsibility for access control and intrusion and intrusion detection as a complete University-wide system falls within the purview of the abovementioned departments and the guidance of the University administration. NAUPASS installations under this division shall provide controlled access to building areas, interior and exterior, real-time monitoring of doors at multiple locations simultaneously, local alarms indicating doors have been forced or held-open, and real time and archived security footage as needed.

Prior to commencement of any access system installation by Contractor, any applicable segment licenses must be requested through Owner (Planning, Design and Construction and coordinated with Campus Services and Activities IT).

All material shall comply with the most current applicable sections of the following codes for installation of access control and intrusion detection cabling:

- 1.) International Building Code (IBC)
- 2.) National Electrical Code (NEC/NFPA70/NFPA731)
- 3.) National Electrical Safety Code (NESC IEEE C2)
- 4.) Local codes, amendment and ordinances

All components, installation practices, and final commissioned systems shall maintain compliance with all applicable sections of the International Organization for Standardization (ISO)/ International Electro-technical Commission (IEC) 27002:2005: Information Security Management Code of Practice.

28 01 10	<p>Operation and Maintenance of Electronic Access Control Systems</p> <p>The electronic access control portion of NAUPASS is a modular and upgradable multi-user, multi-tasking system with granular permissions for control and access that is capable of monitoring, recording and displaying supervised alarm</p>
----------	--

Section Number	Title
	<p>inputs/outputs and reader access activity on a continuous real time basis. All access control panels must have the capability to authorize and verify access and store and manage system activity in both on-line and off-line modes. The panels must operate as standalone units if required for a limited amount of time and automatically download all offline data to the server once reconnected. All control panels must provide for continuous real time polling back to the central processor and must accept firmware updates via network communication. End of line devices will be connected to the field control panels. Any readers connected to access control panels will be polled on a continuous basis to verify connectivity. Any and all changes or modifications shall be coordinated with Owner (CSA-IT and FS Access Services) prior to commencement of activity.</p>
28 01 20	<p>Operation and Maintenance of Electronic Surveillance</p> <p>The electronic surveillance portion of NAUPASS is a modular and upgradable multi-user system with granular permissions for control and access that is capable of monitoring, recording and displaying images and video from multiple cameras and input devices in a continuous real time basis. The individual electronic surveillance units must operate as standalone units if required for a limited amount of time and automatically download all offline data to the server once reconnected. All surveillance footage storage devices must provide for continuous real time polling back to the central server and must accept updates via network communication. The operation and maintenance of electronic surveillance falls under the authority of NAU's Police Department (NAUPD). Any and all changes or modifications shall be coordinated with Owner (CSA-IT and NAUPD) prior to commencement of activity.</p>
28 05 00	<p>Common Work Results for Electronic Safety and Security</p> <p><u>MINIMUM INSTALL REQUIREMENTS</u></p> <p>References to industry and trade association standards and codes are minimum installation requirement standards.</p> <p><u>MANUFACTURED PRODUCTS</u></p> <p>Materials and equipment furnished shall be of current production by manufacturers regularly engaged in the manufacture of such items, for which replacement parts shall be available. When more than one unit of the same class of equipment is required, such units shall be the product of a single manufacturer. Components shall be compatible with each other and with the total assembly for the intended service.</p> <p><u>EQUIPMENT LOCATION</u></p> <p>Final equipment installation shall be in a location conducive and appropriate for the installation of sensitive electronic equipment and as close as practical to locations(s) shown on the drawings. If equipment is to be located in a building</p>

Section
Number

Title

MDF or IDF, room resign and rack/ component placement must be approved by Owner (ITS). If it is deemed by Owner (ITS and PM) and/ or the Design Professional (DP) that the installed equipment is not located appropriately, or is not conveniently accessible for operation and maintenance, or that the equipment is not installed as designed or notated on the drawings, the equipment shall be removed and reinstalled as directed at no additional cost. All access control reader interface modules, reader controllers, or system controllers as well as all remote digital video recorders must be located in rooms that are secured under the Lenel OnGuard Access Control System as a part of NAUPASS.

MANUFACTURED PRODUCTS

Materials and equipment furnished shall be of current production by manufacturers regularly engaged in the manufacture of such items, for which replacement parts shall be available. When more than one unit of the same class of equipment is required, such units shall be the product of a single manufacturer. Components shall be compatible with each other and with the total assembly for the intended service.

SUBMITTALS

In cases of new construction where installer will necessarily coordinate with Contractor and Design Professional, installer shall furnish the following literature and data showing all individual component type and rating and full equipment manufacturer datasheets to Owner and Contractor:

1. Product data for all equipment, hardware cabling and miscellaneous components proposed;
2. Floor plan drawings showing equipment and device locations with proposed conduit, wiring, pull box and junction box locations;
3. Camera mounting details specific to location;
4. Schematic or One-Line drawings – dependent on specific project - of all circuits from the field devices to the required connection points. The diagrams shall show wiring of equipment and all connections to be made to devices. Terminal connections in the equipment shall be numbered to correspond to the diagrams for use in making connections. Wiring diagrams shall be coordinated so that terminal numbering, circuit designation and equipment or device designations are the same on all drawings and coordinated per 28 05 53. All drawings must be submitted and approved by the Design Professional before installation starts, but such approval will not waive any specification requirements unless specifically stated

In cases of individual or standalone electronic safety and security installations, installer shall furnish Owner with the above listed literature and data showing each individual component type and rating and full manufacturer equipment

Section
Number

Title

datasheets. All submittals furnished to Owner shall indicate clearly any variances from original project design documents.

Mark submittal package with specification section number. Do not mix sections in a single submittal.

Mark general catalog sheets and drawings to indicate specific items being submitted and proper identification of equipment by name and/or number, as indicated in the contract documents.

1. Markings shall be reproducible (arrow, underlines, circled, checkmark, etc.).
2. Where sheet or drawing includes options, mark proposed option(s).
3. When manufacturer's reference numbers are different from those specified, provide explanation and cross-reference number for each item.

Work shall not proceed without Owner and DP approval of the submitted item.

No substituted materials shall be installed except by written approval from Owner.

The Owner reserves the right to make changes to descriptive information, component selection and nomenclature during shop drawing review without incurring any additional cost.

EQUIPMENT REQUIREMENTS

Where a variation in equipment or materials is requested from the original approved design drawings, construction documents, or materials quote in accordance with the construction agreement, it is the responsibility of the installer to coordinate work and guarantee compatibility with existing equipment, designed equipment, and any other impacted trades.

OUTAGES/SHUTDOWNS

No outages/shutdowns shall be permitted on existing systems except at the time and during the interval specified by Owner and site representatives. The site may require written approval.

Any outage must be scheduled when the interruption causes the least interference with normal site schedules and business routines. No extra costs will be paid to the Contractor for such outages which must occur outside of regular weekly working hours.

Contractor shall restore any circuit interrupted as a result of this work to proper operation as soon as possible.

Section Number 28 05 13	Title Conductors and Cables for Electronic Safety and Security
-------------------------------	---

Part 1 - General

This section specifies the furnishing, installation, and connection of the conductors and cables for electronic safety and security.

RELATED WORK

- a.) Sealing around penetrations to maintain the integrity of time rated construction: Division 10
- b.) General electrical requirements as related to multiple areas: Division 26
- c.) Conduits for cables and wiring: Division 26 and Division 27
- d.) Requirements for personnel safety and to provide a low impedance path for possible ground fault currents: Division 26
- e.) Power conditioning on system controller boards and door controller boards shall meet minimum requirements: Division 26.
- f.) Requirements for Electronic Safety and Security IP Based Communication Conductors and Cabling: Division 27.

ACCESS CONTROL LINE VOLTAGE AND CONTROL WIRING

- a.) Unless otherwise specified in other sections of these specifications, line voltage wiring shall be as specified by the manufacturer, except the minimum size shall be not less than No. 12 AWG.
- b.) Unless otherwise specified in other sections of these specifications, low voltage control wiring gauge shall be between number 18 and 22 AWG except as specified by the manufacturer.
- c.) Wiring shall be large enough so that the voltage drop under inrush conditions does not adversely affect operation of the supplied equipment or initiate a battery back-up power condition.

28 05 13.16	<p>Access Control Communication Conductors and Cable (Non-IP Based)</p> <ul style="list-style-type: none"> a.) Shall at minimum conform to the recommendations of the manufacturers of the communication and signal system. In the event that communication or signal wiring is related to other divisions and sections in this specification, whichever is greater shall be primary. b.) All cable shall be UL listed. c.) Cable shall be plenum rated unless specifically designated. d.) Multi-conductor cables shall have the conductors color coded.
-------------	---

28 05 26	Grounding and Bonding for Electronic Safety and Security
----------	--

PART 1 - GENERAL

All conductors used for grounding will be color coded green continuously in all visible places, cabinets, equipment, pull boxes, junction boxes, switchboards,

Section Number Title
 etc., or shall be bare copper continuously. Conductors used for isolated grounds shall be green with orange stripe or tracer.

RELATED WORK

- a.) Requirements for live level voltage equipment grounding: Division 26.
- b.) Requirements for low-voltage and communication system grounding: Division 27.

28 05 28 Pathways for Electronic Safety and Security

PART 1 - GENERAL

This section specifies the physical routes and pathways allowable for conductors and cables for electronic safety and security as well as appropriate methodology to install cable along the pathways. All wall, floor, frame, door, etc. penetrations for wire routing shall be sleeved and fire stopped as required and at least one inch in diameter except where approved by Owner. IP-based communication cabling used in electronic safety and security may share common pathways with Division 27 voice/data communication cable as long as all applicable identification protocols are followed and shared cable trays/pathways meet sizing requirements of Division 27 inclusive of all Division 27 and 28 cables.

RELATED WORK

- a.) Requirements for IP-based Electronic Safety and Security hangers and support: Division 27.
- b.) Requirements for IP-based Electronic Safety and Security conduits and back boxes: Division 27.
- c.) Requirements for IP-based Electronic Safety and Security cable trays: Division 27.
- d.) Requirements for IP-based Electronic Safety and Security surface raceways: Division 27.

28 05 28.13 Terminations, Splices, and Connections

- a.) Installer shall splice or otherwise connect cables and wires only in termination back-boxes, junction boxes, or pull boxes, and service length of wire at any connection must be at least eight inches any direction from splice or component. Wires to doors and frames must have accessible junction area / box(s) within 4 feet of door.
- b.) Boxes designated for existing voice/data pathways may not be utilized
- c.) Cover plates for boxes shall conform to Division 26.
- d.) Splices, terminations, and connections shall be mechanically and electrically secure.

28 05 28.29 Hangers and Support for Electronic Access and Security

Section
Number

Title

- a.) Cabling run in plenum spaces shall be self-supported with J-hooks either from the wall or from deck supported hanger wire.
- b.) IP-based communication cable may share J-hooks and cable trays with voice/data cable runs as long as there is an approved physical separation between cable types.

28 05 28.33 Conduits and Backboxes for Electronic Safety and Security Cabling

Conduits and backboxes for electronic safety and Security cabling through areas accessible to the public that cannot be routed through plenum space or interior wall must be run in rigid steel or other form of surface mounted conduit.

- a.) Minimum conduit size of ¾ inch, but not less than the size shown on the drawings.
- b.) All conduit ends shall be equipped with insulated bushings.
- c.) Control wire from the power supply transformer to the door actuator may not share any pathway, conduit, junction box, or backbox with data/voice or communication/signal wire.
- d.) All control wire pathways shall maintain a minimum distance of 12 inches away from any data/voice communication runs.

CABLE PULLING

- a.) Installer shall provide and utilize equipment that will prevent the cutting or abrasion of insulation during pulling of cables.
- b.) Installer shall use ropes made of nonmetallic material for pulling feeders.
- c.) Installer shall attach pulling lines for feeders by means of either woven basket grips or pulling eyes attached directly to the conductors.
- d.) Installer shall pull in multiple cables together in a single conduit.
- e.) Any compound or product used shall be suitable for the wire insulation and conduit it is used with and shall not harden or become adhesive after use.

EXISTING WIRING

Unless specifically indicated on the plans, existing wiring shall not be reused for a new installation. Only wiring that conforms to the specifications and applicable codes may be reused. If existing wiring does not meet these requirements, existing wiring may not be reused and new wires shall be installed.

28 05 53 Identification for Electronic Safety and Security

EQUIPMENT IDENTIFICATION

Any enclosures for access control interface boards or other auxiliary control units that are not located immediately adjacent to or above the door or area that they are associated with must indicate all pertinent information required for

Section
Number

Title

maintenance or repair of equipment including the connected door or area and assigned NAUPASS software identification label.

CONTROL, COMMUNICATION AND SIGNAL SYSTEM IDENTIFICATION

- a.) IP-Based communication cable must follow Division 27 color codes in addition to all other specified Division 28 identification protocols.
- b.) Installer shall place a permanent wire marker on each wire at each termination point in order to allow identification of wire source and destination.
- c.) Permanent wire marker shall correspond to notations on wiring diagrams or as-built construction documents used for installation the system
- d.) Installer shall place a label or otherwise denote the wiring schedule for all terminations of color-coded multi-conductor signal cable. Wire marking is not necessary on individual conductors; however, a schedule of conductors must be visible on the piece of equipment or mounting box.
- e.) Identifying colors on the multi-conductor wire schedules shall correspond to those on the wiring diagrams or as-built construction documents used for installation the system.
- f.) Wire markers shall retain their markings after cleaning.

28 06 00 Schedules for Electronic Safety and Security

The following network configurations will be required for all network components which will integrate/interface with NAUPASS. Each component shall have its MAC address registered through the Owner’s Dynamic Name Service (DNS) to use a fixed DHCP address appropriate to the building or facility subnet. Devices that are required to register addresses and utilize the following network conventions include but are not limited to: intelligent system controllers, intelligent reader controllers, IP surveillance cameras, and Digital Video Recorders. Individual subnets, MAC Address registration, and Fixed-DHCP IP addresses shall be coordinated with Owner’s ITS department. All devices unless otherwise called for, shall use a private address.

IP Subnet Table

Public IP Subnet	134.114.x.x
Private IP Subnet	10.x.x.x
Secure Wireless Subnet	10.18.x.x

All network components which will integrate/interface with NAUPASS and are assigned IP addresses on the NAU network according to the above table will also be required to have a network Hostname assigned that follows the following naming conventions:

Section
Number Title

LNL-{BuildingNumber}-{Device Type}{DeviceNumber}.ss.nau.edu
 ▪ (e.g.: LNL-30-DVR1.ss.nau.edu)

Reference appropriate Building Numbers for facilities on the NAU Campus at:
<http://www.nau.edu/postal/BuildingAddresses/>

Device Type Abbreviation Table

Digital Video Recorder	DVR
IP Video Camera	CAM
3300 Intelligent System Controller	3300PNL
LNL500W Wireless Intelligent System Controller	500WPNL
LNL2200 Intelligent System Controller	2200PNL

28 06 10 Schedules for Access Control
PART 1 - GENERAL

The following schedules and diagrams may serve as a guide for items common to multiple titles in Division 28 but shall serve specifically for Access Control. Additional equipment may be installed with appropriate approval and substitutions may be made as long as all substituted product models are approved by Owner (Campus Services and Activities IT, FS PDC, and FS Access Services).

Integrator is responsible for altering or upgrading any stated equipment model numbers due to manufacturer product model number changes, obsolescence or equipment design.

Integrator shall provide equipment suitable for the capacities indicated in the construction documents. Any discrepancies in quantities shall include the greater quantity in Integrator's proposal.

Quantities listed in the construction documents are to provide location information to the bidding contractors. Integrator shall be responsible for identifying and verifying all equipment quantities and actual placements of devices. Owner is not be responsible for any discrepancies in the quantities of equipment.

Section
Number

Title

PART 2 - PRODUCTS

ELECTRONIC HARDWARE

Components and power supplies to be installed in lockable NEMA rated electrical enclosure(s) 24" x 24" x 6" minimum size, and locked with CAT102 key. Enclosure shall be installed where top of cabinet is no more than 8 feet from floor and bottom is no closer than 3 feet. Power supplies shall be easily switched off and on and shall have battery backup. Owner has pre-approved the following manufacturer to be in compliance with these standards: Lenel

All security system wiring should be 18 to 22 gauge. Wire through door power transfers should be stranded 20 AWG maximum.

All electric door hardware shall be industry standard 24 VDC and inductive devices shall have a local spark arrester.

Where wooden doors exist, 24VDC electric strikes shall be used.

Where hollow metal doors exist, low current draw 24VDC electric handset or exit device shall be used. Owner has pre-approved the following products to be in compliance with these standards: Grade 1 Best 93K or Schlage ND electric cylindrical lockset (with REX) or Von Duprin 98/99 QEL or Security Door Controls SDC QUIET DUO LR100 kit.

No electrical components shall be installed on or in any mullion.

Electrical power transfer hinges are not approved. Owner has pre-approved the following power transfers to be in compliance with these standards: Door loop Keedex K-DL38A, Von Duprin EPT10, Precision EPT5.

Owner has pre-approved the following card reader to be in compliance with these standards: HID RP40E reader to fit a standard single gang device box 920PNNNEK2037Q.

Door position switch shall be flush mount ¾" diameter door switch suitable for metal or wood doors such as George Risk GRI 180-12. Door position switches will be located within three inches of latch-edge of door.

Where a passive infrared request-to-exit (PIR-REX) device with piezoelectric buzzer is recommended, Owner has pre-approved the following manufacturers to be in compliance with these standards: Bosch Security Systems DS160 or Kantech T.REX-XL. PIR-REX devices must be installed to manufacturers'

Section
Number Title

specifications less than 8 feet from floor. Otherwise, local noise will be installed behind a standard 2-gang electrical cover less than 8 feet from floor near opening. Owner has pre-approved the following surface mount wire raceway and boxes to be in compliance with these standards: Legrand Wiremold 700 Series

Automatic door operators (ADOs) will have actuators on both sides of all doors and will be hard wired. Actuators will not be located in the likely path of travel if possible and will be 44" to 48" from grade/floor. ADOs must be properly interfaced to the security system where applicable.

All of the above are true unless otherwise approved by Owner (Access Services).

**Typical System and Door Controller Panel Enclosure
With Fused Power Distribution**

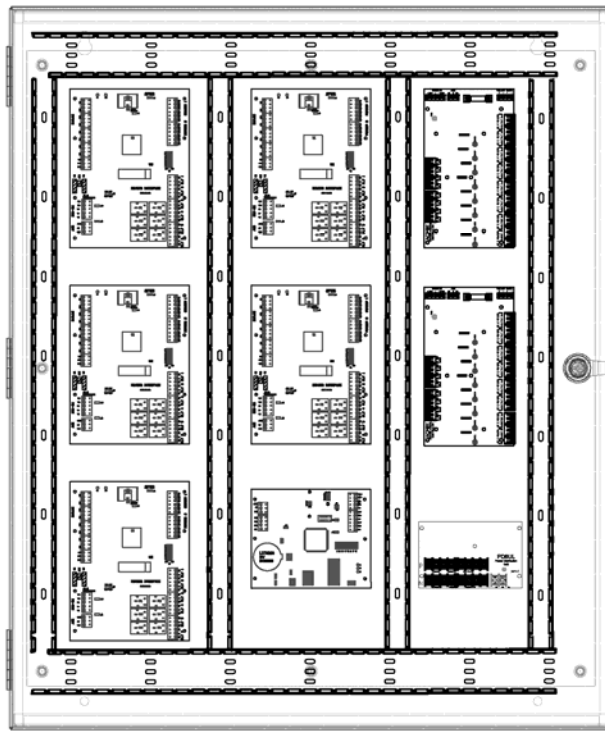

FIELD EQUIPMENT

1	Hoffman	A36N30ALP	36x30 Enclosure
1	Hoffman	A36N30MP	Back Panel
1	Hoffman	A-L12AR	Cylinder Lock Kit
1	GRI	PB2020-T	3/8" Tamper Switch
12'	Panduit	G1X2WH6	1" Panduit

Section Title
Number

12'	Panduit	C1WH6	1" Cover
6'	Panduit	G15X2WH6	1.5" Panduit
6'	Panduit	C15WH6	1.5" Cover
1	Altronix	MAXIMAL75E	12V 10A + 24V 10A Power Supply (Not Shown)
2	Altronix	ACM8CB	Access Power Controller
1	Altronix	PD8UL	Power Distribution Board
3	Yuasa (or equivalent)	NP712	12Vdc, 7Ah Battery (Not Shown)

Typical Single Door with Electrified Handset or Strike

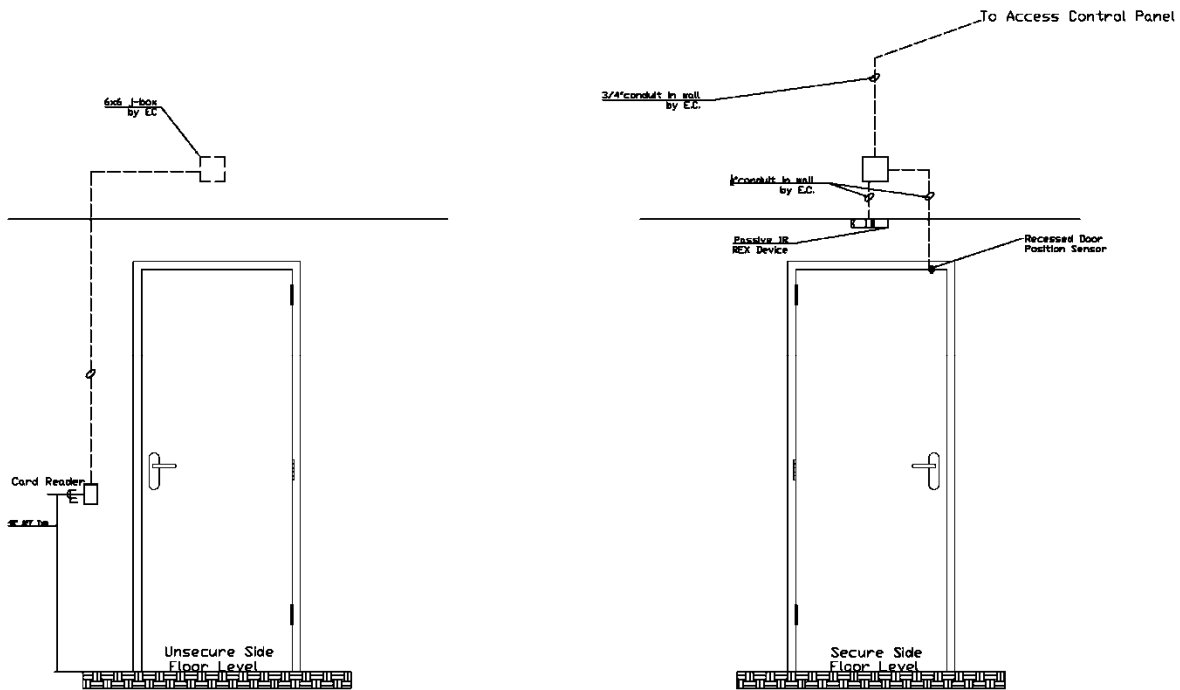

FIELD EQUIPMENT

Card Reader	HID	MultiCLASS SE RP40
Electrified handset or Strike		See Division 8
Passive IR Request to Exit Device	Bosch	DS160 (Light gray w/ sounder)
Recessed Door Position Sensor	GRI	180-12 (3/4" Gray in color)
Controller to REX connection	Belden or Equivalent	AWG 22/6 CMP 6504UE
Controller to DPS connection	Belden or Equivalent	AWG 22/4 CMP 6502UE
Controller to Card Reader connection	Belden or Equivalent	AWG 22/6 CMP 6504FE

Note:

- Automatic door closer to be provided and installed by others but integrated in to the Electronic Safety and Security System by Division 28 Integrator.

Section Title
Number

Typical Single Door with Exit Bar with built-in Request to Exit Device

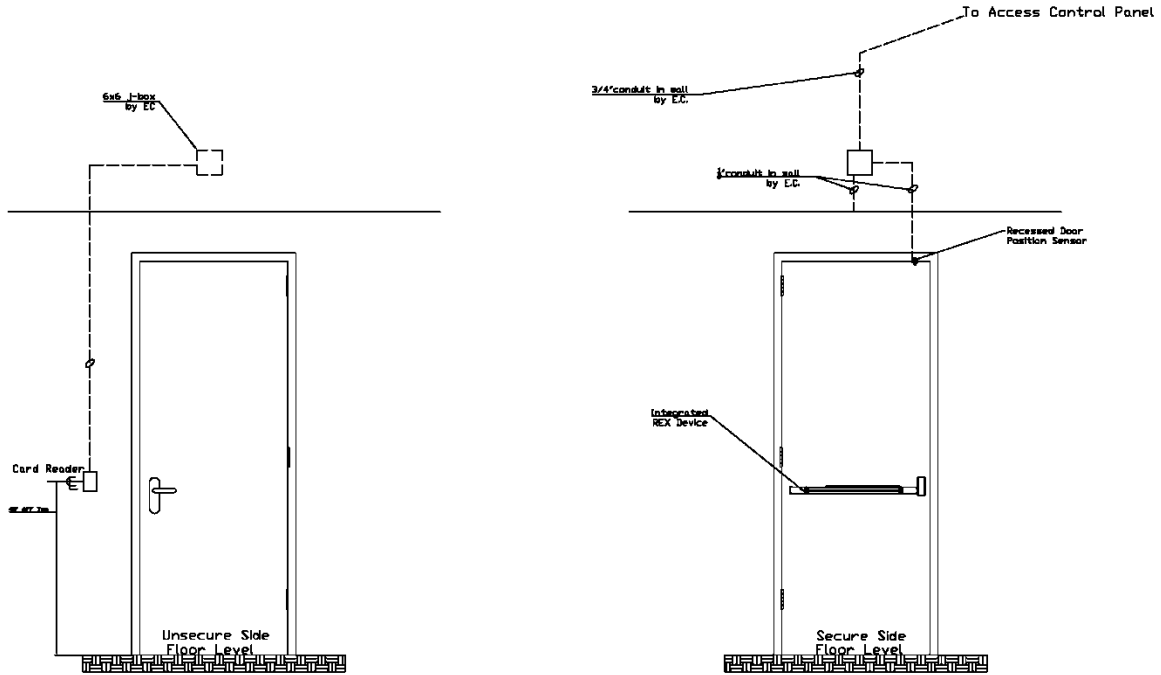

FIELD EQUIPMENT

Card Reader	HID	MultiCLASS SE RP40
Electrified handset or Strike		See Division 8
Passive IR Request to Exit Device	Bosch	DS160 (Light gray w/ sounder)
Recessed Door Position Sensor	GRI	180-12 (3/4" Gray in color)
Controller to REX connection	Belden or Equivalent	AWG 22/6 CMP 6504UE
Controller to DPS connection	Belden or Equivalent	AWG 22/4 CMP 6502UE
Controller to Card Reader connection	Belden or Equivalent	AWG 22/6 CMP 6504FE

Note:

- Automatic door closer to be provided and installed by others but integrated in to the Electronic Safety and Security System by Division 28 Integrator.

28 06 20

Schedules for Electronic Surveillance

Additional equipment may be installed with appropriate approval and substitutions may be made as long as all substituted product models are approved by appropriate NAUPASS Departments.

Integrator is responsible for altering or upgrading any stated equipment model numbers due to manufacturer product model number changes, obsolescence or equipment design.

Section
Number

Title

Integrator shall provide equipment suitable for the capacities indicated in the construction documents. Any discrepancies in quantities shall include the greater quantity in Integrator's proposal.

Quantities listed in the construction documents are to provide location information to the bidding contractors. Integrator shall be responsible for identifying and verifying all equipment quantities and actual placements of devices. Owner is not responsible for any discrepancies in the quantities of equipment.

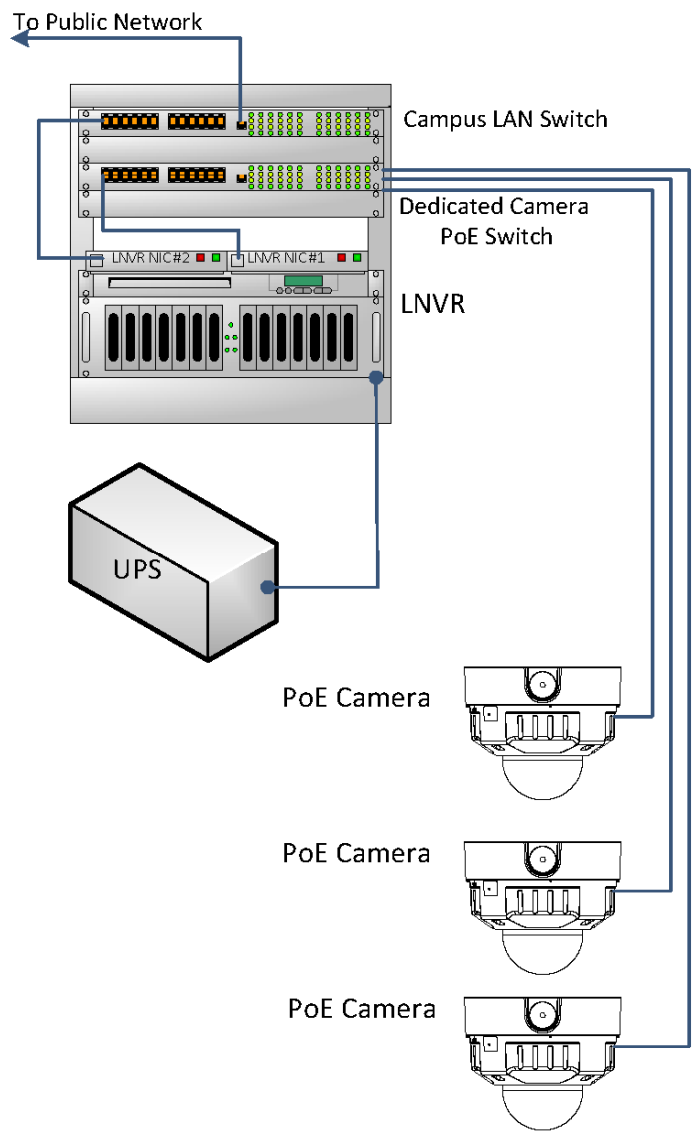

Section
Number
28 08 00

Title

Commissioning of Electronic Safety and Security

Commissioning of Electronic Safety and Security equipment requires the use of the Certificate of Substantial Completion form (FS #81). Upon full execution of the Certificate of Substantial Completion, warranty of equipment and installation shall take effect for a period of not less than two years. Commissioning of Electronic Safety and Security systems must meet stated requirements of the facility manager and conform to requirements specified in the individual applicable Division 28 sections. Any access to the System Architecture or Data Communication infrastructure requires that vendors apply for and secure Affiliate Status with the University. Additionally commissioning shall not be considered to be complete until deliverables listed in this document are transferred to the Owner and appropriate entities specified in the following section requirements:

SUBSTANTIAL COMPLETION REQUIREMENTS

- a.) Owner's current version of On Guard client software must be installed on designated Owner computer(s).
- b.) Minimum of two hours of training on use of client software shall be provided by installer.
- c.) All licenses must be verified to have been implemented and functioning properly by Owner (systems administrators from Campus Services and Activities IT).
- d.) All equipment, including cable ends must be clearly labeled per 28 05 53.
- e.) All system Door Controller and System Board Controller components installed must be properly identified in the On Guard system software according to schema established by Owner (Campus Services and Activities IT).
- f.) All readers must have indicator lights illuminated indicating online or active status and have correct indicator lights and sounds functioning consistently.
- g.) All access levels created for testing must be removed, and at least one access level must be created, tested and verified to be working to the satisfaction of the owner.
- h.) All default manufacturer and vendor provided passwords for both hardware and software components must be changed and transferred to Owner (CSA-IT).
- i.) All door hardware components will be operating correctly and according to Owner expectations.
- j.) Installer will demonstrate successful recording of door activity through alarm monitoring and through system's reporting functionality.
- k.) All components shall be inspected to ensure they have been properly installed, securely attached, and remain clean, unmarred and are fully operational to the satisfaction of Owner.

Section Number	Title
	l.) All broken, damaged or modified items such as walls, doorframes, ceiling tiles, etc., are unacceptable and shall be replaced or properly repaired to the satisfaction of Owner.

DELIVERABLES

- a.) Three (3) final marked as-built record drawings shall be provided by the installer. These shall be delivered grouped with the construction as-builts from the Contractor if applicable to the project.
- b.) Three (3) sets of individual factory issued Equipment Operations and Manuals containing all technical information on each piece of equipment.
- c.) One electronic compiled version of record drawings and O&M documentation shall be delivered to CSA-IT in addition to the printed sets of each.
- d.) A complete schedule of all system components listing:
 - 1.) Final assigned IP address
 - 2.) Final assigned Host Name
 - 3.) Hardware serial number
 - 4.) Hardware MAC Address
- e.) A complete schedule of all system components noting their installed locations and any variance in equipment from original specification must be included and an approved Technical Standards Variance Request Form should be included.
- f.) If required, all extra or spare materials shall be delivered and stored on the premises, as directed.
- g.) A test report of all system components shall be completed and included as part of the closeout submittal to Owner.
- h.) Summary document detailing contents of any Vendor provided license files necessary to accommodate additional Lenel components installed on application server. This file(s) will be tested and installed by the Owner and shall be comprehensive and list separately all existing components as well as new components as part of the project.

WARRANTY

- a.) The system warranty shall be for twenty-four (24) months from the date of Substantial Completion. Provide all equipment, material, and labor required to uphold a full system warranty at no charge to the Owner. All manufacturers' equipment warranties shall be activated in the Owner's name and shall commence on the date of Substantial Completion. In the case of modified equipment, the manufacturer's warranty is normally voided. In such cases, provide the Owner with a warranty equivalent to that of the original manufacturer.

Section Number	Title
	<ul style="list-style-type: none"> b.) There shall be no cost to the Owner for maintenance performed during the warranty period beyond the fixed cost of the contract. c.) Provide a service telephone number, staffed by a qualified technician familiar with the equipment installed. Staff this number during normal business hours. d.) Respond with an on-site technician within 6-hours of a service call (including Saturdays and Sundays) for all equipment and system failures. e.) Replace or repair, at no cost to the owner, any failed equipment hardware or software installations required to provide full system operations within 48 hours. f.) During the warranty period, advise the Owner in writing each time any routine software firmware updates become available, giving the Owner the opportunity to upgrade the software/hardware should they so desire at no additional cost.

28 08 10	<p>Commissioning of Electronic Access Control Systems</p> <p>After all terminations are completed and network components are installed by either Integrator or others, Integrator shall conduct a final inspection and pre-test all equipment and system features required for project prior to final acceptance of the Electronic Access Control System and shall perform the following tests at a time mutually agreeable to both a Contractor representative (if applicable) and an Owner representative from Facility Services PDC and/or CSA-IT. Integrator shall correct any deficiencies discovered as the result of the inspection prior to receiving final acceptance. Integrator may be required to remove covers, open wiring connections, operate equipment, and perform other reasonable work as requested by Owner.</p> <p>At each installed point of Electronic Access Control the Integrator shall:</p> <ul style="list-style-type: none"> 1) Demonstrate that the installed Card Reader is reading, converting, and transmitting card data back to the reader interface module correctly. 2) Demonstrate that the assigned interface module is communicating back to the intelligent system controller (if applicable) and passing the card information through to the Lenel OnGuard Server in Alarm Monitoring. 3) Demonstrate that the Lenel OnGuard server has appropriate segmentation, access levels, timezones, and that the test card credential initiates the proper outputs 4) Demonstrate that the reader interface board or intelligent system controller operates the appropriate output relays in response to the presented card.
----------	--

28 08 20	<p>Commissioning of Electronic Surveillance</p> <p>Integrator shall be responsible for performing the following tests prior to final acceptance of the Video Surveillance System and shall perform these tests at a time mutually agreeable to both a Contractor representative (if applicable) and an Owner representative from Facility Services PDC and/or CSA-IT:</p>
----------	--

Section
Number

Title

- 1) Verify the following for each camera:
 - a. Camera produces a clear picture and is aimed per site requirements.
 - b. Camera maintains a clear picture and automatically compensates for changing light conditions including day/night change.
 - c. Camera has wide dynamic range installed where specified and operate to prevent camera blinding
 - d. Camera provides complete and correct coverage of the area specified.
 - e. Cameras are fitted with anti-tamper/ anti-vandalism devices where specified.
 - f. Simulated tamper alarm is transmitted to the operator workstation.
 - g. Functioning of alarms input(s)/output(s) and/or connections to other systems as specified.
 - h. Camera resolution and encoding settings are configured per minimum requirements (Division 28 23 13) and/or as specified per project documents.
- 2) Verify the following for operator workstation:
 - a. Display orientation/position, camera/view identification.
 - b. Display and/or notification of alarm condition (if applicable).
 - c. Manual control of cameras (if applicable).
- 3) Verify the following for recording and playback functions:
 - a. Data storage capacity is installed on the workstation as specified.
 - b. System hardware supplied is per specification.
 - c. Correct video data is recorded by the system in response to simulated alarms.
 - d. Manual record function operates correctly.
 - e. Playback functions operate correctly including Play, Stop, Pause, Rewind, Fast Forward, Frame by frame view.
 - f. Retrieval of stored video.
 - g. Export of stored video.

Integrator shall be responsible for retaining copies of test results for inclusion in documentation at project completion.

Section Number	Title
-------------------	-------

28 10 00	ELECTRONIC ACCESS CONTROL AND INTRUSION DETECTION
-----------------	--

28 13 00	Access Control
-----------------	-----------------------

The NAUPASS Access Control component consists of items including but not limited to: cabling, network devices, Lenel System Controllers, Lenel Reader Interfaces, HID Readers, Lenel software clients, Lenel credential design and printing software, and Lenel access control servers. NAUPASS Access Control uses Lenel's OnGuard Integrated Security Solution for Door Access and Credential Management. All servers and software associated with NAUPASS are administered by Campus Services and Activities Administration.

28 13 01	Access Control System Installation
----------	------------------------------------

The integrator/ subcontractor for this scope will be responsible for procurement and installation of a complete Access Control System including: all electronic components generally considered to be directly related access control, integration of this system with the existing NAUPASS, and procurement and transfer of all applicable Lenel license files for Owner install. Some of these components will be specified under Division 8 Openings. This shall include hardware attached to the door system or any elements adjacent to the door opening that provide input or receive outputs from the door access system (wired or wireless). Installation details shall be clarified on a project by project basis with the Contractor, if applicable, and Owner.

INSTALLER REQUIREMENTS

Integrator must be an approved Lenel Value Added Reseller (VAR). Integrator must be established as, or must obtain status as, VAR of record for Northern Arizona University in order to purchase Lenel licensing on behalf of the University. Installation of materials and equipment specified under Division 28 must be completed by a Lenel Certified Technician. Any access to the System Architecture or Data Communication infrastructure of NAUPASS requires that vendor apply for and secure Affiliate Status with the Owner. For additional information regarding affiliate status, visit: <https://www.nau.edu/its/services/affiliates/>.

PROJECT MANAGEMENT

Integrator shall provide a project manager who is experienced in the administration and supervision of the security field and electrical work, both within the various types of security integration and with relation to other types of work and who is hereby authorized to act on behalf of Integrator. The project manager responsibilities will include but are not limited to providing schedules, attending project meetings, submittals, safety, quality control, and testing, training and as-built documentation. The project manager must be an employee of Integrator and working in the security field.

Section Number	Title
28 13 13	<p>Access Control Global Applications</p> <p>Access control systems are used on campus for the following applications/purposes:</p> <ol style="list-style-type: none"> a.) To restrict physical access to facilities or other resources through the use of approved electronic access control components connected to NAUPASS including physical separation between multiple departments/operating units in a single facility. b.) To monitor and/or respond to events including intrusions and irregular door statuses through detection monitored by NAUPD and individual department/system segments. c.) To provide reports and audit information for use in investigations by authorized entities d.) To manage, identity, and provide access to NAUPASS through central production and issuance of identification cards. e.) To create and implement schedules and access levels in order to manage physical access to facilities or other resources f.) To record time and attendance in academic classrooms.. g.) To assign privileges to card holders allowing access to special events, or university resources (ie: Athletic Events, After Hours, and Recreation Facilities). h.) Visual verification of identity.
28 13 16	<p>Access Control Systems and Database Management</p> <p><u>SYSTEM ADMINISTRATION</u></p> <p>Campus Services and Activities IT shall be responsible for the following:</p> <ol style="list-style-type: none"> a.) Assist in establishing necessary initial access for installers for testing purposes and/or building owner and their designated Segment Administrator(s). b.) Coordinate the expansion of the existing NAUPASS system to include installation or implementation of the following devices or resources into the system at a software or programmatic level: <ul style="list-style-type: none"> • Additional System Segments. • Alarm Monitoring Zones. • System Roles. • User Accounts. • System Devices such as: DVRs, cameras, door controllers, system boards/ controllers/intelligent system controllers etc. • Licenses: <ul style="list-style-type: none"> ▪ Door Licenses: May be required to be purchased for each additional door added to the NAUPASS system. ▪ Client Licenses: May be required to be purchased for each end user designated to interface with the NAUPASS system.

Section
Number

Title

- Software Licenses: If the usage of components not already installed on the NAUPASS system is required, coordination and consultation with the Dining and Card IT office is required before purchase of the license. DACA IT reserves the right to review, test and if necessary, reject any code, script or custom software intended to interface in any way with the NAUPASS system for ANY purpose.
- Cross Segment Access assignment must be authorized by Owner (NAUPD or Facility Services) at the director level or higher and facilitated through DACA IT.

SEGMENT ADMINISTRATION

Segment Administrator(s) shall be responsible for the following:

- a.) Creating access levels for facilities, doors, or other resources through the On Guard System.
- b.) Assigning access levels inclusive of:
 - Schedules (including Holiday Schedules) – When the door/resource is able to be accessed
 - Doors – Which resource or entrance/exit passages are included.
 - Cardholders – To whom access levels are assigned.
- c.) Removing access from persons no longer affiliated or requiring access.
- d.) Providing additional personnel access to the NAUPASS system.
- e.) Creating Roles within the NAUPASS system to assign to end users within the segment.
- f.) Creating Alarms based on specific events (IF NAUPD is to be alerted of certain events then coordination with NAUPD must be established).
- g.) Obtaining training for usage of the system from Dining and Card Admin IT, through access to user groups, documentation and other available resources.

DATABASE MANAGEMENT

Direct access to any database used with the NAUPASS system is restricted to DACA authorized personnel only. Any request for access to servers containing the NAUPASS database must be submitted in writing to the office of CSA IT, and may require additional administrative approval before such access is granted. Requests must contain contact information, and a detailed explanation of the purpose for the request.

NAUPASS Video Surveillance Systems consists of items including, but not limited to: cabling, network devices, Lenel Network Video Recorders (LNVR), client workstations, connectors, client software licenses, and documentation.

SERVERS

NAUPASS servers are maintained in Hyper V (Microsoft) Cluster. Campus

Section
Number

Title

Services and Activities IT also maintains a “test” server used for development purposes (LNLTEST). Access to any of the servers requires authorization by Campus Services and Activities IT. Any implementations of Door Access MUST utilize existing NAUPASS servers. New servers are not permitted and door access systems may not be managed or implemented independent of the established, existing infrastructure except in special circumstances where prior approval has been obtained from either the NAUPASS committee, or from the Office of the President.

Servers to be used with the NAUPASS system will:

- a.) Have a comprehensive back-up and disaster recovery plan.
- b.) Be housed in accordance with applicable standards.
- c.) Have a primary system application/database server to be housed within Co-Location facility which shall have:
 - Back up emergency power.
 - 24/7/365 access available to authorized Campus Services and Activities IT personnel.
 - FM-200 waterless fire suppression or equal protection approved by Owner (Fire Marshal)
 - Restricted and monitored physical access

Section Number 28 13 19 Title Access Control Systems Infrastructure

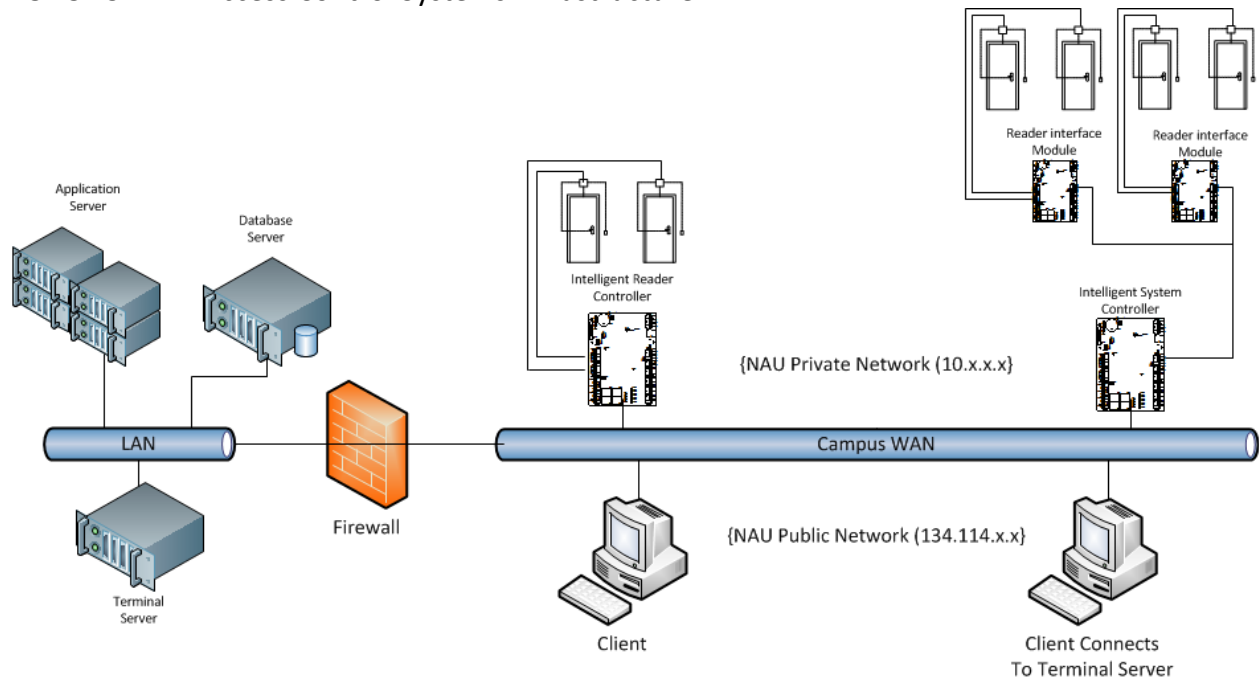

28 13 26 Access Control Remote Devices
 Owner has pre-approved the following manufacturers to be in compliance with these standards:

- Lenel 1320 Dual Reader Interface Module
- Lenel 2210 Intelligent Single Reader Controller
- Lenel 2220 Intelligent Dual Reader Controller
- Lenel 3300 Intelligent System Controller
- HID multiCLASS SE RP40
- HID multiCLASS SE RPK40

28 13 43 Access Control Identification Management System
 Cards or credentials issued by the Owner’s Jacks Card Office are acceptable credentials used for interfacing with the NAUPASS system. All other cards, fobs, RFID, electronic devices, or magnetically encoded devices are strictly prohibited.

28 16 00 Intrusion Detection
 Intrusion detection systems including burglary and/or perimeter protection systems are not currently a component of NAUPASS. Reporting and communications for individual installations must be coordinated directly with NAUPD for monitoring and response.

Section
Number

28 20 00 ELECTRONIC SURVEILLANCE

28 23 00 Video Surveillance System

NAUPASS Video Surveillance Systems consists of items including, but not limited to: cabling, network devices, Lenel Network Video Recorders (LNVR’s), client workstations, client software licenses, and documentation. NAUPASS Video Surveillance uses Lenel’s OnGuard Integrated Security Solution to interface with the electronic video monitoring system. All servers and software associated with NAUPASS are administered by Campus Services and Activities Administration. NAUPASS Video Surveillance System’s architecture consists of decentralized network digital video recorders that are managed by separate segment administrators on campus. Data communications between client computers, servers, and components shall occur on the campus data network infrastructure which is maintained by NAU Information Technology Services Network Operations Center.

28 23 01 Video Surveillance System Installation

The integrator / subcontractor for this scope will be responsible for procurement and installation of a complete video surveillance system including all electronic components generally considered to be directly related to video surveillance including: integration of this system with the existing NAUPASS and procurement and transfer of all applicable Lenel license files for University install. Installation details shall be clarified on a project by project basis with the Contractor, if applicable, and Owner.

INSTALLER REQUIREMENTS

Integrator must be an approved Lenel Value Added Reseller. Integrator must be established, or must obtain status, as VAR of record for Northern Arizona University in order to purchase Lenel licensing on behalf of the University. Installation of materials and equipment specified under Division 28 must be completed by a Lenel Certified Technician. Any access to the System Architecture or Data Communication infrastructure of NAUPASS requires that vendor apply for and secure Affiliate Status with the University. The assigned Project Manager shall at a minimum be an affiliate for this purpose along with the installer if appropriate based on size and scope. For additional information regarding affiliate status, visit: <https://www.nau.edu/its/services/affiliates/>.

PROJECT MANAGEMENT

Integrator shall provide a project manager who is experienced in the administration and supervision of the security field and electrical work, both within the various types of security integration and with relation to other types of work and who is hereby authorized to act on behalf of Integrator. The project manager responsibilities will include but are not limited to providing schedules, attending project meetings, submittals, safety, quality control, and testing,

Section Number

Title

training and as-built documentation. The project manager must be an employee of Integrator and working in the security field

28 23 13

Video Surveillance Control and Management System

Digital Video Recorders (DVR) must be compatible with established NAUPASS (Lenel) infrastructure, and allow live and recorded video to be viewed through the version of Lenel OnGuard Alarm monitoring software in use by Northern Arizona University at the time of installation.

Initial configuration of DVR should conform to the following minimum quality settings.

Minimum Initial Configuration Settings

Recording mode	Frames per second	Resolution
Live	2 fps	640 X 480
Normal	2 fps	640 X 480
Event	3.75 fps	640 X 480

28 23 19

Digital Video Recording Devices

The following equipment is a list of video surveillance digital video recording equipment that is approved for installation on campus:

- Lenel NVR7 models: DVC-LP, DVC-LP2, DVC-ST, DVC-SE, DVC-EX, DVC-HD
- Comparable physical or virtual systems which meet following minimum criteria and are approved by Owner

Minimum System Requirements:

Chassis	1, 2 or 3 RU rack mountable
Processor	Dual Core 2.0 GHZ processor or better
RAM	4 GB
Operating System	Desktop:Windows 7 SP1 Pro or better. Server: Microsoft Server 2008 R2/SP2 or better *32 bit or 64 bit is acceptable.
Hard Drive capacity	**** Varies depending on number of attached cameras. 500GB
Hard Drive Configuration	1 dedicated system drive. 1 dedicated data (video storage) drive
On board Cache	16MB

Section Number Title

Software Version	Lenel Video Suite 7.0.825 or better
------------------	-------------------------------------

- No more than 36 video surveillance remote devices per DVR without exception from Owner.
- NVR's must have uninterruptable power supply capable of providing a minimum of 60 minutes of continuous power in the event of power disruption.

28 23 23 Video Surveillance System Infrastructure

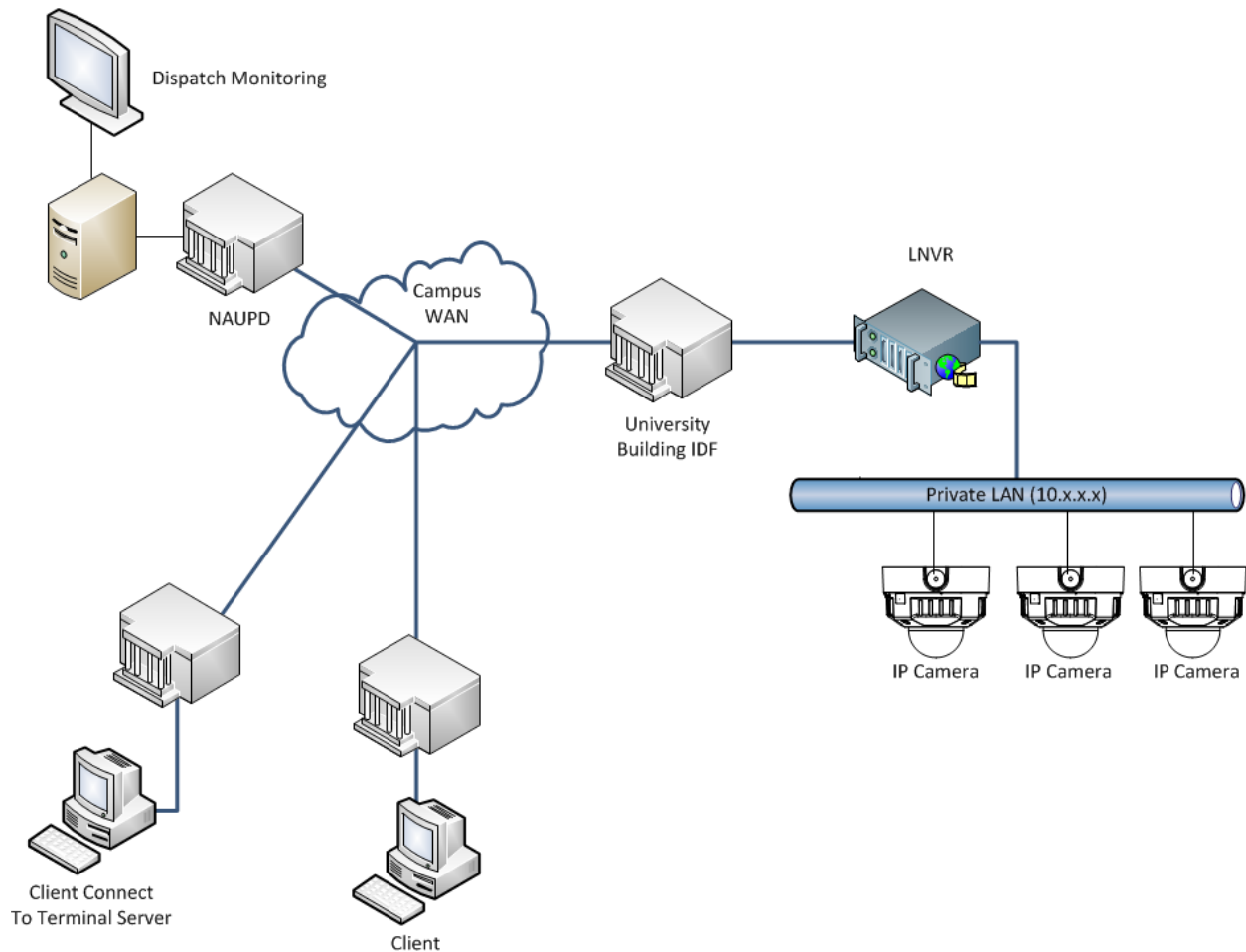

28 23 29 Video Surveillance System Remote Devices and Sensors

All video surveillance remote devices must be listed as compatible with Lenel OnGuard Software and integrated with established campus infrastructure systems. All video surveillance remote devices including cameras, motion and intrusion detection devices used to trigger video surveillance, alarms, and recording equipment must be able to be managed by the OnGuard system.

Section
Number

Title

In addition, all video surveillance cameras shall:

- Be on the current schedule of acceptable Cameras maintained by Owner
- Be digital, transmitting data utilizing Internet Protocol (IP).
- Support a minimum resolution of 720X1280.
- Have the ability to be powered by Power over Internet (PoE).
- Support motion detection
- Be Open Network Video Interface Forum (ONVIF) Compliant.

ACCEPTABLE CAMERAS

Owner has pre-approved the following manufacturers to be in compliance with these standards:

Indoor cameras:

1. Axis Q7406
2. Panasonic WV-NF302
3. Panasonic WV-SP306
4. Sony SNC-DH140
5. Sony SNC-DH180

Outdoor Cameras:

1. Axis Q1755
2. Sony SNC-DM160

28 26 00

Electronic Personal Protection System

The operation and maintenance of any Electronic Personal Protection Systems falls under the authority of NAUPD and the individual university department or administrator as designated by the appropriate Vice President. Any and all additions, changes, or modifications shall be coordinated with NAUPD and the department administration prior to commencement of activity.

Section Number	Title
28 30 00	ELECTRONIC DETECTION AND ALARM
28 31 00	Fire Detection and Alarm

Designer/Installation contractor qualifications

Installation contractor shall be a factory certified authorized distributor – Notifier.

System designer – Fire alarm system plans and specifications shall be developed in accordance with NFPA 72 by persons who are experienced in the proper design, application, installation, and testing of fire alarm systems. System installer – installation personnel shall be supervised (to include conduit, boxes and wiring installation) by persons who are qualified and experienced in the installation, inspection and testing of fire alarm systems.

Qualified personnel shall include, but not limited to, the following:

- Personnel who are factory trained and certified for the alarm system installation of the specific type and brand being installed.
- Personnel who are certified by a nationally recognized fire alarm certification organization.
- Personnel, who are registered, licensed or certified by a State or local authority.

System Requirements

Approved fire alarm equipment manufacturers and control panels:

Notifier:

NFS2 - 3030

NFS2 - 640

NFS – 320

All new fire systems shall be addressable. All fire alarm equipment, components and software shall be nonproprietary and shall be completely field programmable by Owner (Northern Arizona University Fire/Life Safety Personnel [NAU-FLS]).

All new fire alarm systems shall provide In-Building Fire Emergency Voice/Alarm Communication System (EVACS) with female voice. The evacuation messages shall be preceded and followed a minimum of two cycles of the emergency evacuation signal –three-pulse temporal pattern.

The following requirements shall be met for lay-out and design:

- The speaker layout of the system shall be designed to ensure intelligibility and audibility.

Section
Number

Title

- Intelligibility shall first be determined by ensuring that all areas in the building have the required level of audibility.
- The design shall incorporate speaker placement to provide intelligibility.
- System design shall incorporate designation of acoustical distinguishable spaces (ADS).

Contractor shall provide all access-login codes, programming software and minimum four (4) hours training to include all aspects of panel functions, operation, programming and trouble/repair procedures.

Fire Alarm Control Panel (FACP) shall provide communication capabilities:

- **NOTIFIER PANELS:** Notifier NFN Gateway and all required equipment for communication to the OnyxWorks.
- An IP DACT shall also be provided for communication to NAU PD and all points shall be programmed/labeled correctly at the time of project completion.

All academic building fire alarm systems shall include at a minimum detection in all the following areas: all corridors, hallways, mechanical, electrical, telecom equipment rooms. Additional detection may be required in other hazardous locations as identified during the NAU Fire Marshal review.

All residential buildings shall be “total detection” systems and shall provide addressable detectors with sounder bases and visual appliances in all suites/sleeping areas. Addressable in-room detector shall report as a supervisory at the main panel.

All addressable devices and equipment shall provide an external label indicating Signaling Line Circuit (SLC) loop and address.

All academic buildings shall be provided with manual pull stations installed in accordance with NFPA 72.

All residential buildings shall be provided with at least one (1) common area manual pull station.

All building manual pull stations shall be provided from all independent exits from mechanical, electrical and other service or remote exits.

The designated primary entrance shall provide FACP or a remote fire alarm annunciator with required communication equipment.

Section
Number

Title

Main FACP/remote annunciator displays shall be mounted at a height of 64 inches from the floor to the centerline of the display.

All auxiliary panels notification appliance circuit (NAC Power) shall be mounted at a height of 64 inches from the floor to the top of the enclosure.

Pull stations shall be mounted at a height of 48 inches from the floor to the centerline of the pull.

All wall mounted visual /audio devices shall be mounted at a height of 80 inches from the floor or 6 inches below the ceiling to the centerline of the device whichever is lowest.

External battery boxes shall be specifically designed and approved for the purpose of housing batteries and shall be mounted immediately below the main FACP. Battery boxes shall not be installed in sub floors.

Fire alarm detection devices shall be installed as per their listing. Spot type smoke detectors shall be spaced at the detectors UL listing – open areas, corridor, hallways not to exceed 30 feet unless approved by Owner (NAU-FLS) prior to installation.

All beam and duct detectors shall provide remote test/ indication devices.

There shall be no carry-over pre-existing sub-panels in the final system.

All exposed surface mounted fire alarm pull stations, audio-visual devices shall be mounted on back boxes specifically designed for the purpose or provide approved skirts – no exposed boxes with knock-outs (except in areas not normally occupied by the general public – mechanical, electrical rooms, etc.).

Fire Alarm circuits shall be identified at the terminal and junction locations. Identification “Key” or “Legend” shall be consistent with approved installation and as-builts drawings.

All wiring shall be installed in metal raceway – ½” or larger. Flexible Steel Conduits (Maximum 6 foot whip) shall be used only where approved by Owner for connection to equipment which is moveable; connections from a close by junction box to lay-in type device in a "T" grid ceiling. The maximum fill ratio of raceway shall be 50% of the NEC maximum fill. Any exceptions to this requirement shall be specifically granted by Owner (NAUFM).

Section
Number

Title

All fire alarm system conduit, junction boxes, and covers shall be painted red and “J” box covers shall be labeled in bold 1” black decal letters “F/A.”

Existing system shut-down shall be coordinated as described in Division 1 and with Owner’s Fire Life Safety department @ 928-523-4227.

Except for secure areas, electromagnetic door hold-open assemblies interfaced to the fire alarm system should be used on doors in fire rated openings in high-traffic areas, hallways, and entrances to large suites.

Inspections and Final Acceptance

All conduits, boxes, fittings and equipment back boxes shall be inspected by Owner (Fire Life Safety department). No work can be covered up prior to installation inspection. Inspection request shall be in accordance with Division 1.

At system acceptance the Contractor shall provide:

- All relevant manual(s), Technical/Maintenance manual(s),
- Complete As-builts indicating:
 - All system circuits routes and individual circuit identification,
 - Device and equipment locations
 - Device address
 - EOL locations.
 - Auxiliary equipment locations
- NFPA 72 Certificate of completion
- 100% System test printout.
- Two (2) digital copies of the complete system programming using USB devices.

No approval (Green tag) will be issued unless all required information and documentation is provided at the time of final acceptance.

Contractor shall provide two (2) year complete warranty on all system components, programming and installation.

Contractor shall have an in-place support facility with technical staff, spare parts inventory, and all necessary test and diagnostic equipment. Contractor shall provide 2 hour emergency response time.

END OF SECTION

Section Number	Title
32 00 00	EXTERIOR IMPROVEMENTS
32 10 00	BASES, BALLASTS, AND PAVING
32 11 00	Base Courses
32 12 00	Flexible Paving
32 12 16	Asphalt Paving
32 12 19	Asphalt Paving Wearing Courses
32 12 36	Seal Coats
32 12 73	Asphalt Paving Joint Sealants
32 13 00	Rigid Paving
32 13 13	Concrete Paving
32 13 13.01	Concrete Paving –Vehicular Applications
32 13 13.02	Concrete Paving –Pedestrian Applications
32 13 16	Decorative Concrete Paving
32 14 00	Unit Paving
32 14 13	Precast Concrete Unit Paving
32 14 30	Concrete Stepping-stone Pavers
32 14 45	Grass Pavers
32 15 00	Aggregate Surfacing
32 15 13	Cinder Surfacing
32 15 40	Crushed Stone Surfacing
32 15 40.01	Crusher Fines Surfacing
32 16 00	Curbs and Gutters
32 17 00	Paving Specialties
32 17 13	Parking Bumpers
32 17 23	Pavement Markings
32 17 23.33	Plastic Pavement Markings
32 17 26	Tactile Warning Surfaces
32 30 00	SITE IMPROVEMENTS
32 31 00	Fences and Gates
32 32 00	Site Walls
32 32 13	Cast-in-Place Concrete Retaining Walls
32 32 23	Segmental Retaining Walls
32 32 53	Stone Retaining Walls
32 33 00	Site Furnishings
32 33 13	Bicycle Racks and Skateboard Racks
32 33 23	Trash and Litter Receptacles
32 33 33	Manufactured Planters
32 33 43	Seating and Tables
32 35 00	Screening Devices

Section Number	Title
32 39 00	Manufactured Site Specialties
32 39 13	Manufactured Metal Bollards
32 80 00	IRRIGATION
32 84 00	Planting Irrigation
32 90 00	PLANTING
32 91 00	Planting Preparation
32 91 13	Soil Preparation
32 92 00	Turf and Grasses
32 92 16	Plugging
32 92 22	Hydroseeding
32 92 23	Sodding
32 93 00	Plants
32 94 00	Planting Accessories and Mulch
32 96 00	Transplanting

Section
Number

Title

32 00 00 EXTERIOR IMPROVEMENTS

*****EXTERIOR IMPROVEMENTS MUST ADHERE TO THE 2015 LANDSCAPE MASTER PLAN AS WELL AS THE DIVISION 32 TECHNICAL STANDARDS. THE LANDSCAPE MASTER PLAN CAN BE FOUND BY CLICKING ON THE LINK PROVIDED BELOW. NOTE THAT THE EXISTING DIVISION 32 TECHNICAL STANDARDS INCLUDED IN THIS DOCUMENT ARE STILL APPLICABLE DURING THE ROLL-OUT OF THE NEW MASTER PLAN. SOME OVERLAP & DISCREPANCIES MAY OCCUR BETWEEN THE TWO DOCUMENTS AND NOT ALL EXISTING STANDARDS ARE INCLUDED IN THE MASTER PLAN. AS A RESULT BOTH DOCUMENTS ARE TO BE UTILIZED HOWEVER WORK MUST CONFORM TO THE LANDSCAPE MASTER PLAN UNLESS WRITTEN EXCEPTION IS MADE BY OWNER. IT IS THE CONTRACTOR'S AND DESIGN PROFESSIONAL'S RESPONSIBILITY TO IDENTIFY IN WRITING TO OWNER ANY DISCREPANCIES IDENTIFIED BETWEEN THESE TWO DOCUMENTS THAT MAY ALTER A PROPOSAL OR BID.**

2015 LANDSCAPE MASTER PLAN LINK:

http://nau.edu/uploadedFiles/Administrative/Finance_and_Administration/Facility_Services/Documents/DP_Contract/2015%20Landscape%20Masterplan%20Final.pdf

Part 1 – General

This section covers paving, site improvements and landscaping requirements for Owner.

Testing of materials will be by qualified materials testing laboratory hired by either the Contractor or the Owner.

Repaving and striping is required if staging or yard areas for construction are in an existing parking lot or an adjacent street. Any pavement damage or significant increased wear as a result of a construction project's laydown area(s) and/or site operations are the responsibility of the Contractor, and the Contractor shall restore the site back to its original condition. The Contractor may be required to repave the entire parking lot or roadway section. The Contractor may provide an alternate asphalt/concrete treatment to remediate the damaged condition back to a like new condition for review and approval. An alternate treatment would only be considered when recommended, designed, & stamped by a civil engineer registered in the state of Arizona. Any additional assessment, engineering, or other design and construction costs associated with these types of repairs are the responsibility of the Contractor and cannot be charged back to the project budget.

The most current version of the Flagstaff/Coconino County Pedestrian and

Section
Number Title

Bicycle Design Guide (<http://www.flagstaff.az.gov/index.aspx?NID=3181>) shall be used for design and specification of paving and signage for bicycle routes and facilities.

Concrete surfaces shall be provided at motorcycle parking, ADA stalls, and in maintenance areas where oil or gas spillage could occur.

Access ramps shall be provided when the project is located at an intersection and at other intervals along a street if crosswalks are provided. Inclusion of these ramps must be evaluated by the DP with Owner’s involvement for ADA Compliance.

Part 2 – Products

In addition to testing required by the latest revisions of Maricopa Association of Governments for Public Works Construction (MAG), aggregates must be subjected to five cycles of the sodium sulfate soundness test in accordance with the requirements of AASHTO T-104. The total loss shall not exceed ten percent by weight of the aggregate as a result of the test.

Part 3 – Execution

During construction projects that affect the parking areas on campus, the Contractor shall be responsible for providing barricades and appropriate signage for all parking lot entrances.

Signs shall read:

"Parking Lot Closed From _____ to _____
Use Lot # _____"

32 10 00 BASES, BALLASTS, AND PAVING
32 11 00 Base Courses

Part 1 – General

Base course materials and preparation shall be determined by a geotechnical engineer after an investigation of the proposed project area and the existing surface (may be pavement) and subgrade conditions present.

Complete base course design includes subgrade soil preparation information and compaction standards, base course composition, depth and compaction standards. Base course placement will comply with MAG Section 310.

Part 2 – Products

Base course materials shall be tested in accordance with MAG Section 701 and shall be consistent with Section 702.

Section
Number Title

Part 3 – Execution

The aggregate base course to be 6" minimum in depth, (more as defined on a project specific basis) 100% crushed rock conforming to MAG Specification 702, Type B, compacted per ASTM D1557-78;

32 12 00 Flexible Paving

Part 1 – General

Pavements are part of the site grading and storm drainage and will be designed in conformance with the storm water design guidelines. Use of permeable (also called porous or pervious) asphalt requires special permission by the Owner.

Asphalt and pervious or permeable pavements shall be designed by a geotechnical or civil engineer registered in the state of Arizona. A life cycle cost analysis (including proper maintenance procedures) shall be provided for the different types of proposed payment by the DP.

The Contractor shall furnish the Design Professional with a job-mix formula for the asphalt concrete not less than ten (10) days in advance of actual placement of the material. The job mix formula, upon approval of the DP, shall be used to establish the standards to which field test results will be compared, and to determine compliance of the materials furnished with all physical properties of the composite mix and its individual components as shown on the approved job-mix formula. The job-mix formula, with the allowable tolerances for a single test, shall be used for monitoring compliance with the specifications.

Part 2 – Products

Products will be consistent with Section 32 12 16 Asphalt Paving.

Part 3 – Execution

Execution of flexible pavements will be consistent with Section 32 12 16 Asphalt Paving or as specified in the plans and specifications by the DP.

32 12 16 Asphalt Paving

Part 1 - General

This section is written as design guidance for any paving project and is intended to give sufficient detail to provide Design Professional the information required to prepare design development documents (60 %) for asphalt and Modified Asphaltic Concrete (MAC) paving projects throughout campus including roadways, parking lots, driveways, bike paths, pedestrian ways and sidewalks.

Section
Number Title

This section also applies to patching and repairing of the above listed pavements. Further refinement should not be made without specific input from the Owner.

All new and replacement full pavement sections shall include subgrade, base course, asphalt, and chip seal. Patches shall match existing pavement sections.

Throughout the design process (CD 30%, 60%, 90%) formal written approvals are required.

The DP shall follow the recommendations of the geotechnical engineer with regard to pavement design, including but not limited to asphalt cement type, subgrade thickness, and pavement thickness. If a geotechnical engineer has not been retained for the work, then the minimum standards contained in this section shall be used.

Damage to existing utilities shall be repaired and returned to original or better condition by the Contractor.

Cold patching may be used only as a temporary measure. Permanent patches must be hot mix.

If asphalt patch is less than 25 sq. ft., hand method of placement and screening can be used. Materials must be hot mix.

If asphalt patch is greater than 25 sq. ft. or a critical area, use lay down machine.

When working at curbs, widen excavation, form and pour curb, cut straight asphalt edge, and patch.

All asphalt cuts shall be saw cut.

Manholes and valves shall be adjusted to grade after paving. Final adjustment shall be provided with concrete paving patch to roadway grade.

No asphaltic concrete curbing or driveway aprons are allowable.

All utility trench patching shall follow the same requirements as street and parking lot asphalt design, installation, and testing. Utilize "T-Top" trench repair from MAG 200-1.

Testing Requirements:

Contractor will secure an independent testing lab for quality control purposes. The Owner shall employ an independent testing lab for quality assurance. All

Section Number Title

testing shall be documented and reports shall be provided to the Owner on an ongoing basis as soon as the results are obtained. The schedule for testing and results will be developed between the Owner and the lab but shall not be longer than 2 days from when the tests results are obtained. Failing tests are to be reported immediately to the Contractor and the Owner. Retesting required due to test failures are to be paid for by the Contractor. Testing is to be scheduled along with the work, and delays caused by testing will not be subject to change orders for more time.

Asphalt paving shall be tested according to the MAG criteria for asphalt and any additional testing required to confirm consistency to the mix design.

Geotechnical testing shall be provided during paving operations.

In general, paving shall conform to MAG Sections 321- 336 and materials Sections 709 - 717.

Due to the variation in costs between conventional asphalts and polymer modified mixes, Owner may require that alternative mix designs be developed for paving including a low initial cost material and a higher initial cost/longer life material. Designers may use the FHWA spreadsheet RealCost Life Cycle Cost Analysis for evaluating mix designs for life cycle cost. A link to this free software is: <http://www.fhwa.dot.gov/infrastructure/asstmgmt/lccasoft.cfm>

Part 2 - Products

At a minimum asphalt shall be in conformance with AASHTO Designation MP-1, Table I and shall be PG 58-26 for 19 mm asphaltic concrete and PG 58-22 for modified asphaltic concrete (MAG).

MAG Table 710-3 Marshall Mix Design Criteria will be used for both 19 mm (3/4 in) and MAC. The aggregates and mix to be incorporated into the work shall also meet the following additional requirements.

Test	Acceptable	Test Results
AC TYPE Test	19 mm	MAC
Absorbed Asphalt Range (ASTM 1559)	0 - 1%	0 - 1%
Combined Water Absorption (AASHTO T-84)	0 - 2.25%	0 - 2.25%
Marshall Stability (ASTM D1559)	1800 min	1,000 min
Flow (ASTM D1559) Units of .01 inches	8 to 18	15 min
Air Voids Content (mix)	3% to 5%	3% to 5%
Tensile Strength Ratio (TSR) (AASHTO T	0.75 min	0.75 min

Section Title
Number

283, with optional freeze cycle)		
Sodium Sulfate Soundness (AASHTO T-104)	12 % max	12 % max
Percent Carbonates (Arizona test Method 238)	30 % max	30 % max
Binder Content	5.3% to 6.0%	8.0%to 9.0%

All asphaltic concrete and modified asphaltic concrete shall contain a minimum of 1% Portland cement or dry hydrated lime by weight of total aggregate added to the aggregate in a pug mill prior to addition of the binder. The moisture content of the aggregate immediately prior to the addition of the admixture shall be a minimum of 3.0 %.

See MAG for modified asphaltic concrete specifications.

REQUIREMENTS FOR ANIONIC/CATIONIC EMULSIFIED ASPHALT

(revise to include the following for CRS-2P)

**CATIONIC RAPID-SETTING POLYMER-MODIFIED ASPHALTIC EMULSION, CRS-2P
MATERIAL SPECIFICATIONS FOR CHIP SEAL COATING**

Test Description	Test Method	Min	Max
TEST OF EMULSION			
Viscosity, SFS @ 122 F	D244	125	400
Settlement, 5 days, %	D244		5
Storage Stability 1 Day, %	A244		1
Class, Un-coated Par	A502	60	
Particle Charge Test	D244		+
Sieve Test, %	D244		0.30
Oil Distillate, % V of Emulsion	D244		3
Residue by Distillation, %	D244	66	
Tests on Residue by VACUUM RECOVERY A512			
Viscosity, ABS, Poise @ 140 F	D2171	1800	2800
Pen @ 77F, 100g/5 sec, Dmm	D5	40	90
Ductility, 77F, 5 cm/min, Cm	D113	40	
Solubility in TCE, %	D2042	97.5	
Toughness, inch-pounds	(1)	150	

Section Title
Number

Elastic Recovery by means of Ductilometer, %	T301	58	
Tenacity, inch-pounds	(1)	110	
Polymer Content (by wt. Of solids) %	CAL-401	2.5	
TEST ON RTFO RESIDUE			
Aging Ratio, ABS viscosities	D2171		2.5
POLYMER REQUIREMENTS			
Melt flow rate, dg/min 190 C	D1238		45

- 1) Benson method of toughness and tenacity: Scott tester, inch-pounds @ 77°F, 20 inches per minute pull. Tension head 7/8" diameter.
- 2) Upon standing undisturbed for a period of 24 hours, the emulsion shall show no white milky film upon the surface.
- 3) The base asphalt shall be modified prior to emulsification.
- 4) The emulsion shall be pre-certified prior to use. A one-quart sample each of the base asphalt and polymer shall be supplied to the agency 10 days in advance to the project start.

MODIFIED ASPHALTIC CONCRETE

Modified Asphalt Concrete (MAC) shall consist of a mixture of paving asphalt, modifiers and mineral aggregate which, with the addition of mineral filler and blending sand as may be required, shall be mixed at a central mixing plant in the proportions hereinafter specified to provide a homogeneous and workable mixture.

Modified Asphaltic Concrete (MAC) shall consist of furnishing asphaltic concrete with binder meeting the requirements of either:

- Rubberized Asphaltic Concrete (RAC)
- Polymer Modified Asphalt Concrete (PMA)
- Polymer Modified Rubberized Asphalt Concrete – Dry Process (PMRAC)
- SHRP graded PG64-28TR=(TR+)

At the locations shown on the plans in accordance with the following specifications. Within 10 calendar days of notice of award, the Contractor shall submit in letterform, the name of the supplier and a type of MAC to be supplied.

Section Number Title

Contractor shall submit test results from an independent testing company 1 week prior to construction. Application and testing will be in accordance with MAG 321.

MATERIAL

BINDER

The asphalt rubber binder in the mix shall comply with MAG 717 and 335 except the rubber shall be type II and the minimum rubber content for Rubberized Asphaltic Concrete (RAC) shall be 17% as a percentage of total binder. Asphalt cement for all MAC shall meet the requirements of PG 58-22 as per AASHTO MP-1 Table I. Polymer shall be Type SBS and shall be 5.5% to 7% of the total binder for PMA. Twenty percent of the modifier for PMA shall be ground tire rubber. The PMA shall be such that the materials conform to the specification requirements. Ground rubber shall be Type II with the following gradation:

Gradation - Ground Rubber (Type II)

Sieve No.	% Passing
#10	100
#16	70-100
#30	25-60
#50	0-20
#200	0-5

Binder for Rubberized Asphaltic Concrete (RAC) shall conform to the following specifications:

<u>Parameter</u>	<u>Requirement</u>
Apparent viscosity, centipoise, 350°F, Spindle 3, 20 RPM (ASTM D2196)	1500-6000 Centipoise
Penetration, 77°F, dmm, 100g, 5 sec (ASTM D-5)	25 minimum 90 maximum
Penetration, 39.2°F, dmm, 200 g, 60 sec (ASTM D-5)	15 minimum
Cone Penetration, 77°F, dmm,150g, 5 sec (ASTM D-5)	25 minimum
Resilience, 77°F, % (ASTM D-3407)	20 minimum
Softening Point, °F (ASTM D-36)	135 minimum
TFOT Residue (ASTM D1754)	75 minimum
Penetration Retention, 39.2°F, %" "	

Section Number Title

Haake type viscosity may be substituted for field control.

Binder for Polymer Modified Asphaltic Concrete shall conform to the following specifications:

<u>Specification:</u>	<u>ASTM</u>	<u>SPEC. LIMITS</u>	
ORIGINAL ASPHALT	METHOD	MIN.	MAX.
Penetration, 39.2 F (200g/60 sec), dmm	D5	25	
Penetration, 77 F (100g/5 sec), dmm	D5	40	90
Softening point, F	D36	180	
Flash point, F	D92	450	
Ductility, 39.2, F (5 cm/min), cm	D113	30	
Ductility, 77 F (5 cm/min), cm	D113	100	
Viscosity, 275 F, cst	D2170	1000	
Recovery, 39.2 F, %	D113 MOD	60	
Solubility in Trichloroethylene %	D2042	99	
AGED ASPHALT (RTFO)	METHOD	MIN.	MAX.
Retained Penetration, 77 F, %	D5	60	
Viscosity Ratio, 275 F, %	D2170		15
Softening Point, F	D36	175	
Ductility, 39.2 F (5 cm/min), cm	D113	20	

The asphalt binder modifier for the PMA shall contain a minimum of 20% recycled material.

The Polymer Modified Rubberized Asphalt Concrete – Dry Process (PMRAC-DP) and SHRP graded PG64-28TR+ shall conform to requirements of Superpave Grade PG64-28 (AASHTO MP-1 and MAG Section 335) except as follows:

<u>Test Properties</u>	<u>Test Method</u>	PMRAC-DP	
		<u>Specification</u>	<u>Specification</u>
Scrap whole tire rubber (Type II) content, %			
Minimum		17.0	8.0
Trans-polyoctenamer rubber polymer (TOR), %			
Based on the weight of the tire rubber		4.5	

DIVISION 32 – EXTERIOR IMPROVEMENTS

Section Number	Title			
	SBS Polymer content %, Minimum			2.0
	Original Testing			
	COC Flash Point, °C, Minimum	ASTM D92	232	232
	Softening Point, °C, Minimum	ASTM D36	50	50
	Elastic Recovery, 10°C, 10cm, % recovery/1hr, Minimum	ASTM D6084	55	55
	Solubility in Trichloroethylene, Minimum, %	ASTM D2042	97.5	97.5
	Dynamic Shear, 64°C, 10 rad/sec, G*/sin delta, kPa, Minimum	AASHTO TP5	1.00	1.00
	G*/sin delta, phase angle, degrees, Maximum		75	75
	RTFO Residue Testing	AASHTO TP5		
	Dynamic Shear, 64°C, 10 rad/sec, G*/sin delta, kPa, Minimum		2.20	2.20
	PAV Aging Residue Testing	AASHTO TP5		
	Dynamic Shear, 25°C, 10 rad/sec, G*/sin delta, kPa, Maximum		5000	5000
	Bending Beam Rheometer	AASHTO TP5		
	Creep stiffness, -18°C, MPa/60 sec, Maximum		300	300
	M-Value, -18°C, 60 sec, Minimum		0.300	

Aggregate shall conform to Section 710.2.2.

The aggregate gradation will be as follows:

Sieve No.	Percent Passing
5/8	100
1/2	98 +/- 2
3/8	85 +/- 7
4	35 +/- 7
8	20 +/- 5
30	10 +/- 5
200	5 +/- 2

AGGREGATES CHARACTERISTICS

Section
Number Title

Combined aggregates shall conform to 710.2.2 except the minimum sand equivalent shall be 65 and at least 85% by weight of the aggregate retained on the #8 sieve shall consist of particles with at least one rough, angular surface produced by crushing.

MINERAL FILLER AND ANTI-STRIPPING AGENT

Mineral filler and anti-stripping agent shall be as per MAG Section 710.2.3.

MIX DESIGN REQUIREMENTS

The provisions of MAG Section 710.3 MIX DESIGN REQUIREMENTS shall apply to MAC except that:

References to asphalt, liquid asphalt, bituminous cement shall be changed to "binder conforming to 714.2.1."

For estimating purposes, the percentage of binder in the MAC shall be 8% for PMA and RAC. For estimating purposes, the percentage of binder in the MAC shall be 7% for TR+ and for PMRAC-DP. The exact amount of binder in the MAC shall be subject to the Design Professional's approval after review of the Contractor's job mix formula and materials submittals. Marshal mix design criteria will be used for MAC.

PRODUCTION TOLERANCES

The provisions of MAG Section 710.4 PRODUCTION TOLERANCES shall apply to MAC except that:

References to asphalt, liquid asphalt, bituminous cement shall be changed to "binder conforming to 714.2.1."

PRODUCTION REQUIREMENTS

The provisions of MAG Section 710.5 shall apply for MAC except that:

References to asphalt, liquid asphalt, bituminous cement shall be changed to "binder conforming to 714.2.1."

Bituminous binder course shall 2" thick, conforming to MAG Specifications Section 710;

Bituminous surface course shall be 2" thick, conforming to MAG Specifications Section 710.

Sealer coat shall be applied after completion of laying of asphalt. DP to specify time frame and procedures. DP to include in asphalt section design.

Section Number	Title
32 12 19	<p>Asphalt Paving Wearing Courses</p> <p><u>Part 1 – General</u> All new asphaltic pavements shall include a wearing course.</p> <p><u>Part 2 – Products</u> Quick setting and emulsified asphalt per MAG spec type CRS-2. Aggregate gradation shall conform to MAG spec table 716-1 for moderate traffic areas and MAG spec Table 716-2 for high traffic areas. ADOT specification CM 11 will be considered as an alternate subject to availability of MAG specification material and credit price.</p> <p>Submit chip sample for testing prior to application.</p> <p><u>Part 3 – Execution</u> Loose chips shall be swept and removed within a 24-hour period and again at a later date if chips still remain.</p> <p>Contractor is responsible for protection of all manholes and valve covers. All manholes and valve covers shall be marked with non-permanent orange paint and protected with cardboard (or equally effective material) prior to chip sealing.</p>
32 12 36	<p>Seal Coats</p> <p><u>Part 1 – General</u> Bituminous surfacing shall be used only in exceptional cases. Chipseal is the preferred preservation method.</p> <p><u>Part 2 – Products</u> <u>N/A</u></p> <p><u>Part 3 – Execution</u> <u>N/A</u></p>
32 12 73	<p>Asphalt Paving Joint Sealants</p> <p><u>Part 1 – General</u> Expansion joint filler material is used with asphalt pavements per MAG Sections 321-336.</p> <p><u>Part 2 – Products</u></p>

Section Number	Title
	<p>Joint materials shall be in conformance with MAG Section 729</p> <p><u>Part 3 – Execution</u> <u>N/A</u></p>
32 13 00	<p>Rigid Paving</p> <p>This section includes concrete and pervious Portland cement based concrete pavements.</p>
32 13 13	Concrete Paving
32 13 13.01	Concrete Paving –Vehicular Applications
	<p><u>Part 1 – General</u> Concrete ramps must meet the requirements outlined in the Design Guidelines.</p> <p><u>Submittals</u> Shop Drawings: Submit sections and details where not fully dimensioned on the drawings.</p> <p>Manufacturer's Data: Submit for all products.</p> <p>Mix Design: Prior to pouring any concrete, submit concrete mixes for approval in accordance with Division 03. Separate mix designs shall be submitted for each type of concrete to be used in the project.</p> <p>Record of Work: Provide record of time and date of placement, temperature, water additions to the mix, and weather conditions.</p> <p><u>Quality Assurance</u> For placement restrictions see Division 03 Concrete.</p> <p>All materials to conform to Division 03 Concrete</p> <p>Prior to placement of concrete, independent testing lab must confirm subgrade compaction, Owner will confirm that the form placement conforms to the survey and is within the tolerances. Reinforcement shall be tied and supported in rebar chairs as approved by the DP. If welded wire mesh is used, support shall conform with plans and specs. Owner will confirm proper placement and spacing between the rebar or weld wire mesh and the forms.</p>

Section
Number Title

Minimum Thicknesses:

1. Sidewalks not subject to Vehicle Traffic: 4".
2. Sidewalks and Drives subject to Vehicle Traffic: 6".
3. Structurally Supported Slabs (Such as Over Tunnels): As required to meet potential loading conditions.
4. Loading docks: 8"

Part 2 – Products

Reinforcement shall conformance with 03 21 00 Reinforcing Steel.

All loading docks shall be paved in concrete and reinforced per DP specifications.

Provide either welded wire fabric or fibrous reinforcement in concrete. One type is required for all on-grade slabs.

Curbs, gutter and cross pans finished with burlap drag or wood float. Do not plaster surfaces.

Immediately after float finishing sidewalks and ramps, slightly roughen the concrete surface by brooming in the direction perpendicular to the main traffic route. Use fine hair fiber-bristle broom except on inclined slab surfaces provide a coarse, non-slip finish by scoring surface with a stiff-bristled broom, perpendicular to the line of traffic.

Special Finishes: Do not use special finishes such as colored concrete, exposed aggregate, etc. unless specific approval from Owner is obtained. Evaluation will be made on a job-by-job basis. Do not use metal nosings on exterior concrete stairs.

Part 3 – Execution

Deposit concrete near final position on grade with minimum segregation and without damage of subgrade. Consolidate concrete so that concrete shall fill the forms and be free from rock pockets, bee holes, and honeycombing.

Finishing

Use equipment designed to spread, consolidate, screed and float freshly placed concrete in one pass, providing well consolidated, homogeneous mixture, requiring minimum of hand finishing to meet surface tolerances.

Finished surface tolerances:

Section
Number

Title

Tested with 10' straight edge parallel to center line immediately following first floating of surface.

Advance straight edge 5'; space under straight edge shall not exceed 3/16".

Joints

Control joints shall have a minimum depth of 1/4 of the thickness of the slab in the concrete or a minimum of 3/4 inch.

Space at even intervals perpendicular to the path of travel.

The jointing pattern shall be equal to the width of the walk or drive to a maximum of 6 feet o.c. on any side or 10 feet for curb and gutter.

For small concrete replacements the jointing pattern shall match existing adjacent work.

Expansion joints with preformed joint filler in a vertical position, deviating not more than 1/4" from a straight line. Expansion joints shall be installed when abutting existing concrete or fixed structure. Expansion joint material shall be 1/2" thick and shall extend the full depth of contact surface and shall be at a maximum spacing of 60 foot o.c.

Saw Cutting and Patching

Joints shall be sawcut or added during placement with a jointing tool to eliminate random expansive cracking of slab surfaces. Sawcutting shall be performed within 24 hours of the slab

Curing

Required curing practices shall be specified by the Design Professional in the design documents. Contractor shall have curing equipment and accessories ready for use prior to placement of the concrete to ensure prompt curing once the exposed surfaces are finished.

Designers will provide for curing options for warm, dry and cold weather.

Concrete operations: Curing of the concrete should begin immediately upon finishing the surface. Finishing should not be completed until surface bleeding has stopped and the bleed water has dried immediately after finishing and water film has evaporated from surface. Do not use liquid membrane type on surfaces to receive mortar bed finishes.

Field Quality Control / Testing

Section
Number Title

General: All testing, shall be performed by an approved testing laboratory. The following tests and procedures are subject to change during construction at the discretion of the Design Professional.

Control Tests: Control test of concrete work shall be made at such times and in such manner as recommended by the Design Professional, with Owner's approval, at the expense of the Owner. Each test shall consist of 3 standard 6" test cylinders cast and cured in accordance with ASTM C31 and C172. One cylinder shall be broken at the end of 7 days after placing, one cylinder shall be broken at the end of 28 days after placing.. The remaining cylinder will be broken only when the previous test reports indicate unsatisfactory results. Tests shall be made at the time test cylinders are taken, and recorded on the reports to determine the slump, air content, unit weights, and temperature of the concrete. All tests shall be made in accordance with ASTM C39, C138, or C231.

Protection

Protect fresh uncured surfaces from rain.

Cold Weather: Maintain temperature of concrete above 50 degrees F. for minimum five days from placement.

No vehicle loads exceeding design loading. No equipment permitted on new pavement until design strength is attained.

Design Professional to specify cure of 3 to 7 days minimum unless special use / mix.

32 13 13.02 Concrete Paving – Pedestrian Applications

Part 1 – General

This section includes all general concrete paving for pedestrian travel ways or entry features, that do not have special prominence dictating special design finishes.

Part 2 – Products

N/A

Part 3 – Execution

Design Standard

A. 8' minimum design width at all sidewalks, including collector walks at residence hall buildings. Major pedestrian paths of travel ,or

Section
Number Title

major/significant building entries shall be of a width justified by traffic volume and aesthetic precedent. Standard gray, no color or pigment.

- C. Sidewalks should have 6 inches of concrete over 4 inches of base course.
- D. Magnesium floated, with a medium broom finish, perpendicular to the path of travel.
- E. Expansion joints 20' maximum in a single run of paving.
- F. Architectural scoring or joints to be at the same interval as the design width of the subject travel way. Designers option for widths greater than 8', or areas requiring special design consideration, maintaining patterns that are 3'x3' minimum and 12'x12' maximum, square or rectangular.
- G. An additional 3' of width is required for walks that are adjacent to surface parking lots, where the edge facing parking is used as a wheel stop or overhang area.
- H. Walk intersection corners shall be rounded and at all grade changes shall have appropriate curb cuts and transitions that allow full accessibility and safety.
- I. A minimum 12' radius turn-around area is required for any dead-end walk.

32 13 16 Decorative Concrete Paving

Part 1 – General

Special paving methods outlined in this section to be used as an accent in special areas, such as building entries or the Pedway, or areas of significance on campus, such as plazas and gathering spaces. Decorative pavement shall be a simple, unifying element that creates pedestrian scale, and provides ease of maintenance and repair. Colored or stamped concrete is not permitted unless approved by Owner, in instances where flexibility in design elements may be appropriate when the landscape is to be reflective of the architectural design. Generally, the landscape, including pavement, is intended to knit buildings and character zones together.

Submittals and Mock-ups

Prior to installation of decorative pavement, Contractor to provide an 8'x8' mock-up to ensure desired look is achieved and is in conformance with established campus standards. Approval by Owner (project manager and campus landscape architect) is required. Mock-up shall stay in place throughout project duration as a standard for judging completed work. Do not move or destroy mock-up.

Part 2 – Products

Allowable Decorative Paving

Section
Number

Title

Sand Finish Concrete Paving: to be used for the Pedway and special gathering areas such as plazas, courtyards, and building entries. Owner to provide Design Professional with standard design for Pedway at applicable projects. Concrete shall meet Owner standards and be 6" thick, fibermesh reinforced overlaying 4" of compacted aggregate base course. Concrete mix design must contain 60% fine aggregate and 40% large aggregate to achieve sand finish. Standard gray to be used, no color or pigment. Sand finish to be achieved using surface retarder as follows:

- A. 'Top Cast' by Grace Construction Products or approved equal
- B. Number code: grade 05
- C. Etch/aggregate size to expose: light sandblast finish
- D. Coverage: 250-350 square feet per gallon
- E. Retardant removal per manufacturer's standards, typically within 6-24 hours after application. Timing of removal dependent upon temperature to create desired finish.

Integral Color Concrete Paving: for use at Pedway only, at bike lane. Specify 'graphite' pigment, Davis Colors (mix 2 lbs of 8084 per 1 cu. ft. of cement). Owner to provide Pedway design at applicable projects.

Sealer to be applied to decorative concrete paving after 28 day curing period unless otherwise directed by Owner. Owner has pre-approved the following product to be in compliance with these standards: Weather Worker 40% J29 Sealer.

Part 3 – Execution

Medium broom finish, perpendicular to path of travel.

Expansion joints 20' maximum in a single run of paving, except to be 37.5' at Pedway.

Architectural scoring or joints to be at the same interval as the design width of sidewalks. Design Professional's option for widths greater than 8', or areas requiring special design consideration, utilizing patterns that are 3'x3' minimum and 12'x12' maximum, square or rectangular.

At Pedway, use 2' long, ½" diameter rebar dowels at 2'-6" o.c. to tie pedestrian and bicycle lane sections together.

32 14 00 Unit Paving

32 14 13 Precast Concrete Unit Paving

Part 1 - General

Section
Number Title

Pavers should be a simple, unifying element to create a pedestrian scale and provide ease of maintenance and repair. Pavers can be used as an accent material in outdoor gathering spaces with no vehicular traffic. Use in vehicular areas shall be limited and as approved by Owner.

Submittals and Mock-ups

Prior to construction of the sample pavement, Contractor to submit one set of six units each for each type and color of paver required, showing full range of colors and textures. Pavers shall be consistent with the materials palette in the Landscape Master Plan and per Part 2 - Products, below.

Materials included in the palette are the only materials allowed for use at the exterior of all new buildings and renovations.

For all new and infill concrete unit pavers adjacent to existing pavement, a 36 square foot sample pavement (mock up) shall be constructed on site near the proposed work area to evaluate the selected paver for matching. Contractor shall allow for sufficient time for the Owner and the DP to evaluate and approve the proposed pavement.

On new construction, a minimum 36 square foot sample pavement (mock up) shall be constructed to establish the standard of acceptance for all elements of the work, including but not limited to: curbing and expansion, bond pattern, tie-in with other materials and finishes, accessories, etc. The sample panel shall be approved by the Owner and the Design Professional prior to ordering materials and commencement of paver work.

Retain sample pavement (mock-up) during construction as a standard for judging completed unit paver work. Do not move or destroy mock-up until work is completed.

For roadway applications, pavement section should include a concrete subbase for pavers. Consult with geotechnical engineer if the area will have vehicular traffic.

Part 2 – Products

Paver units shall be whole and undamaged prior to installation. Units that are chipped, cracked, broken or stained are not allowed

Section
Number

Title

Provide materials obtained from only one source for each type and color of pavers.

Bedding and joint sand shall be clean, non-plastic, and free from deleterious or foreign matter. The sand shall be natural or manufactured from crushed rock. The sands shall be as hard as practically available.

Sound durable particles free from organics, clays, deleterious and foreign matter. Use an aggregate base course material per MAG Section 702.

Bed Sand shall conform to ASTM C33 and joint sand shall conform to ASTM C144 not more than 1% passing No. 200 sieve.

Pavers must be 4" x 8" x 3 1/8" (80 mm) or 4" x 18" x 3 1/8" (80 mm).

Paver Materials

Owner has pre-approved the following manufacturers to be in compliance with these standards:

- Belgard Holland Pavers, 4" x 8" x 3 1/8" (80 mm), 'Sedona Blend,' or approved equal. Sand-set, concrete subbase required.
- Belgard Plankstone, 4" x 18" x 3 1/8" (80 mm), 'Rio' (blend of charcoal and gray), or approved equal. Sand-set, concrete sub-base required.

ACCESSORIES

Upon recommendation by the geotechnical engineer, a geotextile fabric may be specified for paver installation. Use of fabric is reserved for areas with clay soil or damp conditions.

Part 3 – Execution

Contact Bluestake before conducting any excavations. See procedures in Division 1.

Excavate the pavement area to allow for the pavers and the bedding sand layer.

Prepare subgrade soil per the recommendations of the soils report. In all cases, this will include even grading of the area and compaction. The subgrade shall be free from water, clay and rocks. If recommended, provide a geotextile fabric.

Verify location, type, installation and elevations of edge restraints around the perimeter area to be paved.

Section Number	Title
	<p>Place an approximately 1-1 ¼ inch deep sand bed. Use polymeric sand in joints where sand washing out of joints will be an issue.</p> <p>Lay out work in pattern provided in the plans and specs to minimize cutting. Cut pavers as necessary to fit within the edge restraints.</p> <p>Lay the pavers with consistent spacing for joints and provide an even flat surface with no elevation deviation between pavers of greater than 1/16" will be unacceptable. Pavement tolerance of 3/16" is allowed over a distance of ten feet.</p> <p>Install per MAG detail 225 with modifications per manufacturer's recommendation.</p>
32 14 30	<p>Concrete Stepping-stone Pavers</p> <p>Generally, for limited use along seat walls as a skateboard deterrent. This design requires high level of maintenance and should be limited to special design areas.</p> <p>Preferred size: 2' square. Standard gray concrete (no color or imprint). Must be surrounded by bluegrass turf or low ground cover. Surrounding with unplanted mulch or gravel is not acceptable.</p>
32 14 45	<p>Grass Pavers</p> <p>To be used where contiguous lawn areas are desired to provide subgrade support for pedestrian or vehicular fire truck traffic. Install per manufacturer's specifications. Owner has pre-approved the following manufacturers to be in compliance with these standards: Grasspave.</p>
32 15 00	Aggregate Surfacing
32 15 13	Cinder Surfacing
32 15 40	Crushed Stone Surfacing
	<p><u>Part 1 – General</u></p> <p>Gravel roads shall be constructed with the proper cross section to allow for drainage and maintenance. Use the Coconino county lot split standard for sloping of roadway bed and shoulders for emergency and maintenance access driveways.</p>

Section Number Title

Part 2 – Products

If no geotechnical recommendations are available surfacing and subgrade for gravel roadways, use the recommended gradation from the EPA gravel roadway guidelines: <http://www.epa.gov/nps/gravelroads/>.

Requirement	Aggregate Base Course	Gravel Surfacing
Sieve	Percent Passing	Percent Passing
1"	100	
3/4"	80-100	100
1/2"	68-91	
No. 4	46-70	50-78
No. 8	34-54	37-67
No. 40	13-35	13-35
No. 200	3-12	4-15
Plasticity Index	0-6	4-12

Part 3 – Execution

Contractor to call bluestake before grading the roadway area.

Excavate within the area to allow for driveway material, shoulders, and drainage areas.

Scarify and compact the subgrade per MAG Section 301

Install the subgrade ABC per MAG Section 310.

Install the crushed stone (gravel surfacing) wearing course per MAG Section 310.

32 15 40.01 Crusher Fines Surfacing

Part 1 – General

May be used at seating areas or as secondary, informal path in forested area or through lawn or native grass areas. Use concrete border at paths. Not to be used at building entries, areas with high velocity stormwater runoff, areas that require snow plowing, or primary circulation routes.

Part 2 – Products

¼" minus 'Madison Gold' decomposed granite with fines.

Use CE-Structural Soil or approved equal as subbase material where new trees are planted in crusher fines. Planting pit to be 10' diameter minimum.

Section Number	Title
	<p>Tackifier may be used when trees (new and existing) are not planted in crusher fines area.</p> <p><u>Part 3 – Execution</u> Install 4” thick without weed fabric. Proper subgrade preparation, an underdrain system, or a minimum slope should be utilized to assist drainage.</p>
32 16 00	Curbs and Gutters
	<p>Curbs are used to define the roadway areas and for drainage control.</p> <p><u>Part 1 – General</u> For concrete curbs see Division 03 Concrete.</p> <p><u>Part 2 – Products</u> <u>N/A</u></p> <p><u>Part 3 – Execution</u> <u>N/A</u></p>
32 17 00	Paving Specialties
32 17 13	<p>Parking Bumpers</p> <p>Parking bumpers shall only be specified for pavement installations within 2’ of existing structures or fences.</p>
32 17 23	<p>Pavement Markings</p> <p>All roadway pavement markings other than lane striping are to be thermoplastic . They may not be painted.</p> <p>Painted traffic markings to be 4" wide and contain glass beads.</p> <p>All bike lane assemblies, turn arrows, stop bars, crosswalks, or similar roadway pavement markings are to be thermoplastic.</p> <p>Typical right angle parking stalls are to be installed at a minimum stall size of 9’x18’ and are to be striped on-center of these dimensions. Refer to the Design Guidelines for additional detail on ADA parking stalls.</p>

Section Number Title

Parking lot striping color schemes:

White – Used for vehicle stall lines & motorcycle parking hatched areas

Yellow – Hatches used for no parking of any type. Stenciled inside “no parking”.

Blue – Hatched Accessible aisles, ADA Stall Lines & Accessible Icons. Stenciled “no parking” inside of hatched areas.

Red – Curbs, Fire Lanes, & Hatched Areas anywhere we do not want there to be parking. Typically associated with fire truck access areas. Stenciled “no parking” inside of hatched areas.

32 17 23.33 Plastic Pavement Markings

Preformed Thermoplastic Pavement Markings

1. **USE:** A durable, high skid resistant, retroreflective pavement marking material suitable for use as interstate shields, route shields, bike path, roadway, intersection, airport, commercial or private pavement delineation and markings.
 - 1.1. The markings must be a resilient white, yellow or other color thermoplastic product, the surface of which must contain glass beads and abrasives in an alternating pattern. The markings must be resistant to the detrimental effects of motor fuels, lubricants, hydraulic fluids etc. Lines, legends and symbols are capable of being affixed to bituminous and/or Portland cement concrete pavements by the use of the normal heat of a propane torch.
 - 1.2. The markings must be capable of conforming to pavement contours, breaks and faults through the action of traffic at normal pavement temperatures. The markings shall have resealing characteristics, such that it is capable of fusing with itself and previously applied thermoplastic when heated with the torch.
 - 1.3. The markings shall not have minimum ambient and road temperature requirements for application, storage, or handling.
2. **MANUFACTURING CONTROL AND ISO CERTIFICATION:** The manufacturer must be ISO 9001:2008 certified and provide proof of current certification. The scope of the certification shall include manufacture of reflective highway markings.
3. **MATERIAL:** Must be composed of an ester modified rosin resistant to degradation by motor fuels, lubricants etc. in conjunction with aggregates, pigments, binders, abrasives, and glass beads which have been factory produced as a finished product, and meets the requirements of the current edition of the Manual on Uniform Traffic Control Devices for Streets and Highways. The thermoplastic material conforms to AASHTO designation M249-79 (98), with the exception of the relevant differences due to the material being supplied in a preformed state.

Section Number Title

3.1. Graded Glass Beads:

3.1.1. The material must contain a minimum of thirty percent (30%) intermixed graded glass beads by weight.

The intermixed beads shall be clear and transparent. Not more than twenty percent (20%) consists of irregular fused spheroids, or silica. The index of refraction shall not be less than 1.50.

3.1.2. The material must have factory applied coated surface beads and abrasives in addition to the intermixed beads at a rate of 1/2 lb. (± 20%) per 11 sq. ft. The surface beads and abrasives must be applied in an alternating arrangement across the surface of the material so that the surface is covered in what is best described as a “checkerboard” pattern of glass beads and abrasive materials. The abrasive material must have a minimum hardness of 8 (Mohs scale). These factory applied coated surface beads shall have the following specifications:

- 1) Minimum 80% rounds
- 2) Minimum SiO₂ Content of 70%;
- 3) Minimum refractive index of 1.5
- 4) Maximum iron content of 0.1%

Size Gradation		Retained, %	Passing, %
US Mesh	Um		
12	1700	0 - 2%	98 - 100%
14	1400	0 - 6%	94 - 100%
16	1180	1 - 21%	79 - 99%
18	1000	28 - 62%	38 - 72%
20	850	62 - 71%	29 - 38%
30	600	67 - 77%	23 - 33%
50	300	86 - 95%	5 - 14%
80	200	97-100%	0 - 3%

3.2. Pigments:

3.2.1. White: The material shall be manufactured with sufficient titanium dioxide pigment to meet FHWA Docket No. FHWA-99-6190 Table 5 and Table 6 as revised and corrected.

3.2.2. Red, Blue, and Yellow: The material shall be manufactured with sufficient pigment to meet FHWA Docket No. FHWA-99-6190 Table 5 and Table 6 as revised and corrected. The yellow pigments must be organic and must be heavy-metal free.

3.2.3. Other Colors: The pigments must be heavy-metal free.

Section Title
Number

- 3.3. Heating indicators: The top surface of the material (same side as the factory applied surface beads) shall have regularly spaced indents. These indents shall act as a visual cue during application that the material has reached a molten state so satisfactory adhesion and proper bead embedment has been achieved and a post-application visual cue that the installation procedures have been followed.
- 3.4. Skid Resistance: The surface of the preformed retroreflective marking materials, wherein every other shaped portion contains glass beads, or abrasives with a minimum hardness of 8 (Mohs scale), shall upon application provide a minimum skid resistance value of 60 BPN when tested according to ASTM: E 303.
- 3.5. Thickness: The material must be supplied at a minimum thickness of 90 mils (2.29 mm) or 125 mils (3.15 mm).
- 3.6. Retroreflectivity: The preformed retroreflective marking materials upon application shall exhibit adequate and uniform nighttime retroreflectivity. The marking materials shall have the following retroreflectivity as measured using a Delta LTL 2000 or LTL-X Retroreflectometer:

White preformed reflective marking materials—minimum of $275 \text{ mcd}\cdot\text{m}^{-2}\cdot\text{lx}^{-1}$

Note: Initial retroreflection and skid resistance are affected by the amount of heat applied during installation. When ambient temperatures are such that greater amounts of heat are required for proper installation, initial retroreflection and skid resistance levels may be affected.

- 3.7. Environmental Resistance: The material must be resistant to deterioration due to exposure to sunlight, water, salt or adverse weather conditions and impervious to oil and gasoline.
 - 3.8. Abrasives: The abrasives and surface beads must be applied in an alternating arrangement across the surface of the material so that the surface is covered in what is best described as a “checkerboard” pattern of glass beads and abrasive materials. The abrasive material must have a minimum hardness of 8 (Mohs scale).
4. **APPLICATION:**
- 4.1. Asphalt: The materials shall be applied using the propane torch method recommended by the manufacturer. The material must be able to be applied without minimum requirements for ambient and road temperatures and without any preheating of the pavement to a specific temperature. The material must be able to be applied without the use of a thermometer. The pavement shall be clean, dry and free of debris. Supplier must enclose application instructions with each box/package.

Section Number Title

4.2. Portland Concrete: The same application procedure shall be used as described under Section 4.1. However, a compatible primer sealer may be applied before application to assure proper adhesion.

5. **PACKAGING:** The preformed thermoplastic markings shall be placed in protective plastic film with cardboard stiffeners where necessary to prevent damage in transit. Linear material must be cut to a maximum of 3' long pieces. Legends and symbols must also be supplied in flat pieces. The cartons in which packed shall be non-returnable and shall not exceed 40" in length and 25" in width, and be labeled for ease of identification. The weight of the individual carton must not exceed seventy (70) pounds. A protective film around the box must be applied in order to protect the material from rain or premature aging.

6. **TECHNICAL SERVICES:** The Contractor shall provide technical services as required.

32 17 26 Tactile Warning Surfacing

Where ever curb ramps are installed they shall comply with the Design Guidelines for universal accessibility. These ramps shall also include a tactile warning area paved using detectable warning/cast iron truncated domes in an area determined by the ADA Design guideline requirements. Use Neenah Foundry cast iron truncated dome, or approved equal.

****END OF SECTION****

32 30 00 SITE IMPROVEMENTS

Part 1 – General

All site improvements shall be designed with sustainability in mind and shall conform to the Design Guidelines for Sustainability. Consider Low Impact Development (LID) stormwater management, snow plowing and storage,

Section Number Title

maximum accessibility, and other innovative practices for design of site improvements.

NAU’s Landscape Master Plan, Principles, Standards and Concept Designs section to be referenced for supplemental information. Site improvements shall conform to the Landscape Master Plan. Proposed design and construction drawings to be reviewed by Owner’s campus landscape architect for approval. Requirements set forth in the Technical Standards, Landscape Master Plan and Owner’s campus landscape architect’s review shall be incorporated into the construction documents prepared by the DP. Where discrepancies exist, Owner (campus landscape architect) shall be consulted and Owner shall have ultimate authority on final decisions.

Part 2 – Products

Products used for site improvements are covered in Sections 31 00 00 and 32 00 00.

Part 3 – Execution

If no direction is given in the plans and specs follow manufacturer’s recommendations or MAG applicable sections.

32 31 00 Fences and Gates

Part 1 – General

Refer to NAU Landscape Master Plan, Principles and Design Standards, Railing section, for specific information regarding allowable locations on campus, including appropriate character zone (Historic North, Central Innovation, or Mountain South) and site placement. Also refer to concept plans in Landscape Master Plan for guidance regarding preferred type and placement.

Generally, fencing, railing and handrails to be treated as a unifying campus element with consistent use of specified materials while allowing some variability in design.

Part 2 – Products

Allowable materials and locations as per below. Variations to be approved by Owner.

Temporary, non-structural barrier: may be used to discourage pedestrian access or to protect newly installed landscaping during establishment period. Standard is plastic black post and chain.

Section
Number Title

Ornamental black iron fencing design with brick masonry pillars: May be used at north and central campus to define campus edges. Replicate existing style, including cap, brick, and metal detailing. Not for use at interior campus areas.

Rustic steel with natural stone base: Can be used at south campus when separation rail is needed for pedestrian safety. Use Corten or weathering steel, pre-treated to induce rusting and then sealed to reduce staining. Use concrete cap and stone base/pillars (natural sandstone or limestone), sealed.

Stainless or galvanized steel handrail/fall protection railing: To be used throughout campus in all character zones, at stairs or ramps, or areas requiring fall protection. Specify stainless or galvanized steel (non-painted), rounded top rail with round or square vertical supports welded to top rail. With Owner approval, black or green painted railing may be specified at certain locations where existing context dictates. Fall protection railing to have 4” maximum vertical or horizontal spacing.

Weathering steel handrail/fall protection railing or fencing: to be used at south campus at stairs or ramps, or areas requiring fall protection or fencing. At pedestrian gathering areas, treat with muratic acid and peroxide to induce rusting, followed by sealant to prevent staining of concrete/rubbing off of rust. If unsealed, offset from concrete to prevent staining. When used as handrail/fall protection railing, specify rounded top rail with round or square vertical supports welded to top rail. Fall protection railing to have 4” maximum vertical or horizontal spacing. Existing railing in good condition may be painted to match weathering steel. When used as fencing, match FUTS (Flagstaff Urban Trail System) design.

Part 3 – Execution

No unique requirements. Install per manufacturers’ requirements.

32 32 00 Site Walls

Mock-up shall be constructed by Contractor to establish the standard of acceptance for all elements of the work. The sample wall shall be approved by the Owner and the Design Professional prior to installation.

Retain mock-up during construction as a standard for judging completed. Do not move or destroy mock-up until work is completed.

Refer to NAU Landscape Master Plan, Principles and Design Standards, Walls section, for specific information regarding allowable locations on campus, including appropriate character zone (Historic North, Central Innovation, or

Section
Number

Title

Mountain South) and site placement. Also refer to concept plans in Landscape Master Plan for guidance regarding preferred wall type and placement.

Stucco, CMU and basalt stone not to be used for site walls. Pre-cast block to be only as specified in Section 32 32 23.

Construction and plans for all site walls shall be approved by Owner to ensure appropriateness of materials, design, and placement.

Skateboard deterrent: Exterior planters, seat walls, and retaining walls shall be designed to deter skateboard use. Metal skatestops are not permitted. Acceptable methods to be used:

Breaks or interruptions every three feet minimum along top of wall/at wall cap, using 1" deep x 2" wide sawcuts. Cuts shall be designed to be integral to site element.

Chamfered or rough edges which are less likely to be ground down.

Strategically placed landscape beds or lawn/native grass areas.

32 32 13

Cast-in-Place Concrete Retaining Walls

Part 1 – General

Concrete work to conform to Technical Standards Division 3: Concrete.

Part 2 – Products

Exposed surfaces of cast-in-place concrete low-height (approximately three feet) freestanding and retaining walls to be sand finish, in North zone along North-South Pedway only, and throughout central and south campus. Sand finish must match Owner’s established standard for appearance and quality, to be standard gray, without color or pigment, beveled/chamfered edge preferred.

Wall cap options as follows:

North zone (along Pedway only) and Central zone: no cap, to provide clean lines and modern detailing, or utilize sand finish concrete cap (standard gray) for more classic appearance.

South zone: sand finish concrete cap (natural gray) for classic appearance, or Belgard Hardscapes ‘Tandem’ cap, ‘Danville Beige,’ to mimic look of natural limestone.

Part 3 – Execution

Section Number	Title
	Contractor to construct wall mock-up for Owner approval; mock-up is to remain throughout project duration.
32 32 23	<p>Segmental Retaining Walls</p> <p><u>Part 1 – General</u> Contractor to submit product sample to Owner (Project Manager and campus Landscape Architect) and DP prior to purchase.</p> <p><u>Part 2 - Products</u> Owner has pre-approved the following products to be in compliance with these standards:</p> <ul style="list-style-type: none"> • Low height freestanding or retaining walls to be Belgard ‘Tandem’ wall and cap, color: ‘Danville Beige,’ all three solid unit sizes: 13”, 15” and 18”; ashlar pattern units not allowed. Free-standing wall up to 30” high, gravity wall up to 36” high, maximum height with engineering is 8’ high. To be used in North and South campus character zones. May be used in Central zone with campus landscape architect approval only. Appropriate application as a seat, edge or planter wall, with strategic location required to deter skateboarding. • Mass segmental retaining walls to be used where higher retaining walls are required. Product to be Belgard ‘Mega-Tandem Wall,’ ‘Danville Beige’ with ‘Mega-Tandem’ cap. Can be used for free-standing seat walls up to 36” high, gravity retaining walls up to 10’ high without surcharge, and reinforced walls up to 15’ high. Wall terracing is preferred, with plantings, to soften visual impact. To be used in North and South character zones, or Central zone with campus landscape architect approval only. <p><u>Part 3 – Execution</u> Install per manufacturer’s direction.</p>
32 32 53	<p>Stone Retaining Walls</p> <p><u>Part 1 – General</u> In Central campus, clean lines and modern detailing shall be used. Sandstone and limestone in natural form to have tight coursing with long rectangular blocks and smooth face. In North campus, pitched, chiseled faces are desired to mimic the stonework at the campus historic buildings. In south campus, drystack limestone is preferred. Use of natural stone may be able to be coordinated with Owner (Landscaping & Outdoor Services) in some instances, using Owner’s stockpiles.</p>

Section
Number Title

Stone sample(s) to ensure desired visual appearance, including coloration and facing, along with testing data, to be submitted to Owner for approval. Required testing for sandstone, to be performed by a registered geologist, is ASTM C-170 Standard Test Method for Compressive Strength of Dimension Stone, including parallel and perpendicular loads. Provide test results to Owner for review and approval prior to selection of stone source. Limestone shall be hard enough to avoid cracking and fracturing. Testing for limestone to be at Owner's request.

Anti-graffiti product to be applied following completion of stonework. Apply silane/siloxane sealer before application of anti-graffiti product to provide protection against water absorption and penetration, prolonging life of the stone. A silane/siloxane sealer is preferred above a sealer containing only one of these ingredients. Owner has pre-approved the following product to be in compliance with these standards: Vandlguard.

Part 2 – Products

Limestone Walls

Classic Limestone Wall

- A. Character zone: North
- B. Placement: high visibility accent areas and seat walls.
- C. Wall cap: natural limestone.
- D. Rectangular blocks 6"-12" high and 12"-18" long with pitched, chiseled face.
- E. Rock and mortar color to match existing campus limestone.
- F. Source to be within 500 miles of campus

Modern Limestone Wall

- A. Character zone: Central
- B. Placement: high visibility accent areas and seat walls.
- C. Wall cap: none
- D. Drystack large cut blocks, 2'-3' in length and 12"-18" high maximum.
- E. Rock color to match existing campus limestone
- F. Source to be within 500 miles of campus

Drystack Limestone Wall

- A. Character zone: South
- B. Placement: seat walls, edge wall, and retaining walls under 3 feet high.
- C. Wall cap: none
- D. Drystack large blocks in natural form, 2'-3' in length and 12"-18" high maximum.
- E. Rock color to match existing campus limestone
- F. Source to be within 500 miles of campus

Section
Number

Title

Sandstone Walls

Classic Sandstone Wall

- A. Character zone: North
- B. Placement: high visibility accent areas and seat/edge walls.
- C. Wall cap: natural limestone/beige sandstone, manufactured concrete (Belgard 'Tandem'), or sand finish concrete cap
- D. CMU with sandstone veneer
- E. Rectangular blocks 6"-12" high and 12"-18" long with pitched, chiseled face
- F. Raked mortar joints with color pigment to match natural stone
- G. Source within 500 miles of project location
- H. Minimum 4" thick veneer with rock bedding planes parallel to ground to discourage spalling.

Modern Sandstone Wall

- A. Character zone: Central
- B. Placement: high visibility accent areas and seat/edge walls.
- C. Wall cap: none, or sand finish concrete cap
- D. CMU with sandstone veneer in ashlar pattern
- E. Rock color should match existing red sandstone on campus
- F. Raked mortar joints with color pigment to match natural stone.
- G. Source within 500 miles of campus
- H. Recommended veneer to be 4" thick with rock bedding planes parallel to ground to discourage spalling.

Part 3 – Execution

Contractor to construct wall mock-up for Owner approval, and mock-up shall remain throughout project duration.

Cast-in-place retaining walls with a stone veneer shall be sealed on the side which contacts soil to prevent efflorescence from appearing on the outside of the wall.

All stone veneer walls shall not have stonework extend below grade or surface of adjacent pavements and walks. At least two inches of the foundation shall be exposed above adjacent grade level.

32 33 00 Site Furnishings

Refer to NAU Landscape Master Plan, Principles and Design Standards, Furnishings section, for specific information regarding allowable locations on campus, including character zone (Historic North, Central Innovation, or

Section Number	Title
	<p>Mountain South) and site placement. Also refer to concept plans in Landscape Master Plan for guidance regarding preferred furnishing type and placement.</p> <p>Furnishings appropriate for each site/building shall be included in the project. Furnishings should be durable, either placed or designed to deter skateboarding, and composed of sustainable materials. Central campus furnishings, at certain areas, are encouraged to be expressive in design.</p>

32 33 13	Bicycle Racks and Skateboard Racks
----------	------------------------------------

Part 1 – General

Existing bike racks of the same model may be re-used on projects with the Owner’s (Project Manager and campus landscape Architect) approval. Existing bike racks that are re-used shall all match in color and finish within the same location.

Part 2 – Products

Bike Rack

- A. Character zone: campus-wide
- B. Placement: near building entrances, between buildings, or at social gathering spaces.
- C. Owner has pre-approved the following manufacturer to be in compliance with these standards: Madrix Model UT160, hot-dipped galvanized (no powder-coating/non-painted), one to five loops.

Skateboard Rack

- A. Character zone: campus-wide
- B. Placement: near building entrances, between buildings or at social spaces.
- C. Owner has pre-approved the following products to be in compliance with these standards: Board Loch brand products ‘Genesis 7,’ ‘Spartan 7,’ or ‘Spartan 14,’ Zinc plated finish.

Part 3 – Execution

Install per manufacturer’s direction, on a separate concrete pad from the sidewalk/path of travel.

32 33 23	Site Trash and Litter Receptacles
----------	-----------------------------------

Part 1 – General

Big Belly is the preferred, primary trash/recycling receptacle to be used on Owner’s campus. Alternate receptacle, landscape forms, can be used at

Section
Number

Title

secondary areas if approved by Owner (Project Manager and Landscape Architect).

Part 2 – Products

Owner has pre-approved the following manufacturers to be in compliance with these standards:

1. Big Belly solar-powered trash and recycling stations
 - A. Character zone: campus-wide
 - B. Placement: areas requiring receptacles, including near building entries, social spaces, and along pedestrian circulation routes.
 - C. BB5 HUB (Big Belly 5) compactor with SB5 (Smart Belly 5) companion recycler (COMPANION RECYCLER-L; left side companion, never right side), Big Belly hopper to be standard black, Smart Belly faceplate, icon in blue (never ‘flap’) faceplate. Visual Order Tools (VOTs) to be sent to Owner for sign-off/approval; without the foot controlled opener, as it will assuredly become stuck/damaged in snow clearing efforts

2. Landscape Forms 'POE'
 - A. Character zone: campus-wide
 - B. Placement: areas requiring receptacles, considered secondary spaces on campus, as an alternate to Big Belly.
 - C. Powder-coated metal, color: ‘Titanium,’ side opening without lock to permit access in winter conditions.
 - D. Litter and recycling receptacles.

Part 3 – Execution

Place on a concrete pad or other paved surface.

32 33 33

Site Manufactured Planters

Part 1 – General

Planter below is a pre-approved planter to be used. Alternate planters may be considered on a case-by-case basis if approved by Owner.

Part 2 – Products

Quick Crete Products Corp. precast concrete ‘Cascade Round’ series planter

- A. Character zone: campus-wide
- B. Placement: Pedestrian gathering areas, building entries
- C. Color: ‘Latte’, texture: ‘Craftsman’s Etch,’ standard gloss sealer, drain hole
- D. 36” outside diameter x 18” height (or other size variation as approved)

Section Number	Title
	E. Watering saucer preferred to limit staining of concrete from soil organics

Part 3 - Execution

No unique requirements

32 33 43	Site Seating and Tables
----------	-------------------------

Part 1 – General

Some existing benches may be replaced with tables and chairs to deter skateboarding and increase social activity. Benches should be placed to capitalize on mountain views and in more intimate quiet spaces.

Custom furnishings may be included with approval from Owner. In Central Campus Character zone, expressive furnishings design may be encouraged significant campus gathering areas.

Part 2 – Products

Benches:

Owner has pre-approved the following manufacturers to be in compliance with these standards:

Metal Bench

- A. Character zone: campus-wide
- B. Placement: Gathering areas with crusher fines or pavement
- C. Landscape Forms ‘Parc Vue,’ powder-coated metal, color: “Titanium,’ backed bench with arms
- D. Custom skateboard deterrent required (provided by manufacturer)

Bamboo Bench without Arms

- A. Character zone: campus-wide
- B. Placement: memorial benches and intimate seating areas
- C. Anova ‘Allure’ Bamboo 6’ Contour Bench, bamboo slat color: ‘Fawn,’ Fusion Advantage finish color: ‘Pewter’
- D. Custom skateboard deterrent desired (provided by manufacturer) unless strategically located
- E. Concrete pad or footings required for supports

Tables and Chairs:

Attached

- A. Character zone: campus-wide
- B. Placement: Pedestrian gathering areas

Section
Number Title

- C. Landscape Forms ‘Carousel,’ powder-coated metal color: ‘Titanium,’ chairs with or without backs, perforated seats and table
- D. Anova ‘Beacon Hill,’ bamboo slat color: ‘fawn,’ fusion advantage finish color: ‘pewter,’ flat or contour seats

Moveable

- A. Character zone: campus-wide
- B. Placement: Pedestrian gathering areas with increased security, so that furniture cannot be removed, i.e. fenced area
- C. Landscape Forms ‘Catena’ tabletop steelhead perforated without umbrella hole, ‘Parc Vue’ 24” single backed bench seat, powder-coated metal color ‘titanium’

Umbrellas

- A. Character zone: campus-wide
- B. Placement: optional with Landscape Forms tables and chairs
- C. Landscape Forms ‘Solstice Cygnus,’ powder-coated metal custom colors: NAU blue or gold
- D. Canvas umbrellas not allowed

Chairs

- A. Character zone: central and south campus
- B. Placement: Pedestrian gathering areas
- C. Adirondack chairs: Loll Designs Adirondack Collection 4 slat, flat, (standard or rocking), colors: charcoal, evergreen, leaf, custom NAU blue
- D. Chaise Lounge: Maglin MCL720 Series-M, powder-coated steel, south campus colors: ‘Bronze 14’ or ‘Silver 14,’ central campus colors: ‘Graphite,’ ‘Silver 14,’ or custom NAU blue

Other/Custom Furnishings:

Picnic Table

- A. Character zone: campus-wide
- B. Placement: Pedestrian gathering areas with crusher fines or concrete pad (not in grass). Strategic placement required to deter skateboarding.
- C. 6’ or 12’ length, supports to be smooth standard gray concrete, weathering steel or Corten, seats and table top to be sustainable wood product approved by Owner, i.e. Black Locust Wood or other. If weathering steel is used, it must be treated with muratic acid and peroxide to induce rusting and then sealed to prevent staining of concrete.

Section Number Title

Harvest Table

- A. Character zone: Central and South campus
- B. Placement: Pedestrian gathering areas with crusher fines or concrete pad (not in grass). Strategic placement required to deter skateboarding.
- C. 24’ length, supports to be smooth standard gray concrete, weathering steel or Corten, seats and table top to be sustainable wood product approved by Owner, i.e. Black Locust wood. Rainforest sourced wood not permitted. If weathering steel is used, it must be treated with muratic acid and peroxide to induce rusting and then sealed to prevent staining of concrete.

Solar Charging Station

- A. Character zone: campus-wide
- B. Placement: Pedestrian gathering areas with crusher fines or concrete pad (not in grass).
- C. ‘Soofa Core’ in custom NAU blue, or other as approved by Owner.

Bar Style Seating

- A. Character zone: Central campus
- B. Placement: Only where specified in Landscape Master Plan Concept Designs. Strategic placement required to deter skateboarding.
- C. Swivel seating design encouraged

Skateboard Bench

- A. Character zone: Central and South campus
- B. Placement: Areas where skateboarding can be encouraged. Place adjacent to skateable surface. Not to be used in high traffic areas.
- C. Stainless steel edge required, standard gray concrete (no color or pigment).

Double-sided Wood Deck Lounge Chair

- A. Character zone: Central and South campus
- B. Placement: Only where specified in Landscape Master Plan Concept Designs. Strategic placement required to deter skateboarding.
- C. Sustainable wood product approved by Owner i.e. Kebony, Black Locust. Rainforest sourced wood not permitted.

Chammock

- A. Character zone: Central campus
- B. Placement: Only where specified in Landscape Master Plan on concept design plans.
- C. All weather fabric that is water and mildew resistant, stainless steel or galvanized steel supports, colors: NAU custom blue or gold.

Section Number Title

Hammock

- A. Character zone: South campus
- B. Placement: Only where specified in Landscape Master Plan on concept design plans.
- C. Provide hammock hooks and tree protection.
- D. All weather fabric that is water and mildew resistant, stainless steel or galvanized steel supports, colors: NAU custom blue or gold.

Part 3 – Execution

Generally items should be anchored in concrete so as to not be removed.

32 39 00 Manufactured Site Specialties

32 39 13 Manufactured Metal Bollards

Part 1 – General

Manufactured metal bollards shall be collapsible when placed in fire access routes.

Part 2 – Products

Preferred product is MaxiForce™ Traffic Control Bollards, manufactured by Blue Ember Technologies or equivalent. Part ID is MCSW-SS3-S, Description: MaxiForce Collapsible (MC) Bollard, Standard Style (S) Rectangular Body, Wrench (W) Operated, Standard Style 3 (SS3) Head, Simple (S) Base, One Wrench Included Per Every 10 Units. Color is Bengal Silver Drylac 049/99999 powder coat. Standard Duty Aluminum Release Insert (breakaway insert) is recommended.

Part 3 – Execution

Installation shall be per manufacturer’s recommendations.

****END OF SECTION****

Section Number	Title
32 80 00	IRRIGATION
32 84 00	Planting Irrigation

Part 1 – General

All irrigation systems for new construction shall be designed as part of the landscaping plans and shall be considered in the grading, and storm water management of the site and the surrounding areas. The Design Professional shall include adequate irrigation for planting and use reclaimed water for irrigation where it is available. Planning shall work towards plant and designs that allow for irrigation to be phased out as landscaping becomes established. At maturity irrigation will be limited to climate stresses only.

The Contractor is responsible for all blue staking before and during the project.

Warning Tape: Each 2” line shall have warning tape provided directly above line, 12 inches below finished grade, except 6 inches below subgrade under pavements and slabs. **All main lines shall have tracer wires for efficient locating.** Provide detectable warning tape (“water” blue for domestic and potable water and “reclaimed” purple for reclaimed water) with metallic core encased in a protective jacket for corrosion protection for irrigation mains, conduit or other underground services outside of building line.

Reduced pressure backflow preventers shall be installed at all connections to water distribution mains. Immediately downstream of the back-flow preventer shall be a master valve and brass Rainbird EFB-CP flow sensor of appropriate size.

Drawings

Prior to construction, preliminary design plans must be submitted to Owner (Landscaping and Outdoor Services) for approval. At the completion of each project, accurate, reproduceable, as-built drawings shall be provided to Owner. AutoCad compatible files (*.dwg, *.dxf) shall be provided so the sprinkler system may be entered into the campus infrastructure data.

Part 2 – Products

Pipe and Fittings

All pipe used for main lines and auxiliary lines shall be schedule 40 PVC pipe with ratings printed on pipe.

All fittings shall be schedule 40, pressure rated, PVC fittings.

Section
Number

Title

Fittings between the auxiliary (lateral) line and any sprinkler head or hose bib shall consist of rigid PVC full circle swing joint.

Specifications for piping shall include standards that all piping shall be free from cracks, holes, and foreign materials, blisters, inside bubbles, wrinkles, and dents.

If pipe is stored outside it shall be protected from direct sunlight.

No galvanized nipples, elbows, or other fittings shall be used with PVC pipe installations.

Standard specifications for the piping materials shall include that the pipe shall be free from cracks, sunburn, discoloration, holes, foreign materials, blisters inside, bubbles, wrinkles and dents.

Controllers

The controller shall be Calsense ET2000e Irrigation Controller.

Flow Sensors shall be Calsense FM Flow Sensors.

The master valve (EFB-CP) will be located in the control box.

Controller Wires

Electronic controller cable to be solid copper wire, UL approved for direct burial, minimum gauge 14 UV for runs under 1000 L.F., 12 UF for runs over 1000 L.F. Control wires must be buried at least 18" below finish grade.

Electric control wires shall be color coded so that neutrals are white, grass areas are red, shrub areas are blue, flower beds are green and drip irrigated areas are brown.

All connections to valves and all splices shall be made with "SNAP-TITE" connectors and PT-55 sealer, or approved equal.

Valves

Valves shall have a minimum size of 1". EFB-CP Series Rainbird. Ball valves to be installed before all control valves for isolation.

Sprinkler Heads

Heads for lawn areas less than 25 feet wide shall be Hunter I 20 or approved equal.

Heads for strips and shrubs shall be Rainbird 1800 series,

Section Number Title

Heads for open areas 25 feet or wider shall be Hunter I 40 or approved equal.

Heads for large areas with few trees shall be Hunter I40 or approved equal.

Backflow Prevention

Backflow preventers shall be reduced pressure type and shall be installed at all connections to domestic water distribution mains. Owner has pre-approved the following manufacturers to be in compliance with these standards: FEBCO and WATTS. Reclaimed water mains will require pressure reducing valves (PRV).

Part 3 – Execution

Trenching: Cover Requirements:

All pipe and wire under pavement	24"
Pressurized Lines	18"
Non-pressurized lines	12"
Non-pressurized drip laterals	8"
Control Wire	18"

Lines bordering curbs and sidewalks shall be held 12" away to allow for maintenance and access to the lines.

Backfill around and over pipes shall be with sandy soil free from rocks over 1/8" in diameter. Where existing soil does not meet this requirement, sandy soil shall be imported for backfilling.

Pipe and control wiring and tubing under walks, roads and other hard surfaces shall be installed in schedule 40 sleeves that are two times the size of the pipe. Sleeves shall extend a minimum of 12" beyond the hard surface.

Heads, bubblers, and drip lines shall maintain a minimum of 2' 0" setback from walks, drives or building faces. Special care shall be utilized in design to avoid the possibility of wind driven mist from wetting paving and building surfaces.

Pipe and Fittings

All main lines shall be looped whenever possible so as to improve pressure and flow.

Glued joints shall set for 24 hours before pressure is applied to lines.

If pipe is stored outside, it shall be protected from direct sunlight.

PVC joints shall be glued according to manufacturer’s recommendations.

Section
Number Title

Control Wires

Lawn, shrub, flower beds, xeriscape and drip areas shall be valved separately and have separate stations on the time clock.

All splices shall be made in valve boxes.

All wire runs shall have expansion loops at all corners.

Valves

All valves shall be EFB-CP Series Rainbird valves. Avoid locating valves in areas where curbs and walks come together.

Main valves should be located, when possible, in a grassed area, five feet from sidewalks curbs, or other traffic areas. Ball type isolation valves installed vertically before all control valves.

Valve boxes shall be set at finished grade, before sod, with valve stems 4" below top of the box. Each valve box or group of valves shall have a quick connect on the pressure side of the valve.

Valves to be separated where possible.

All valves shall be placed in valve boxes so to allow access for servicing. 3" of gravel shall be placed under all valves (electric, gate and sectional).

Controllers

Controllers shall be mounted on the exterior of buildings or any other proximate built structures.

Heads

Placement of heads shall be influenced by prevailing wind direction, location of mounds and placement and location of trees.

Heads shall be installed so that the top of the head is flush with the finish grade **BEFORE** sod.

Provide diagrams for all head installation.

All lines shall be flushed before the heads are installed.

A non-fading, weather resistant copy of the irrigation diagram and controller name-label shall be affixed to the inside of the controller cabinet door. The

Section
Number Title

irrigation diagram shall show all valves operated by the controller, valve sizes and type of plantings irrigated.

Backflow Prevention

All backflow preventers shall be assembled with pipe fittings and risers of galvanized steel, or copper.

Valves and drains shall be placed so the entire system may be winterized.

Trenching

Immediately downstream of the back-flow preventer shall be a water meter or flow sensor of appropriate size. Flow sensors shall be installed at least 2 feet upstream and at least two feet downstream of any joints to ensure accurate readings.

1. Main lines shall be a minimum of 24 inches deep; auxiliary lines shall be 4 inches deeper than the bottom of the head being used.
2. Lines bordering curbs, sidewalks or other hard surfaces shall be held 12 inches away to allow for maintenance and access to the lines.
3. Sand shall be used in all trenches as bedding material for all PVC piping and also used as a covering for all piping. There shall be a minimum depth of 2 inches over the top of all piping.
4. Pipe, drip tubing and control wire being routed under walks, roads or other hard surfaces shall be installed in schedule 40 sleeves.

Warning Tape

Provide warning tape in the trench with irrigation lines 12 inches above the line and provide detectable warning tape with metallic core encased in a protective jacket for corrosion protection, detectable by metal detector for irrigation mains, conduit or other underground services outside of building line.

32 90 00 PLANTING

Part 1 – General

Design Professional shall coordinate hardscape design with size of plant pits and planting areas so as to provide adequate root growth area, including planning for mature trunk flares and proper subgrade material in pavement areas (i.e. CU Structural Soil), and eliminate conflicts with hardscape and utilities. Refer to Section 32 93 00 Execution regarding offset distances between trees and utilities.

Section Number Title

The Contractor shall maintain all plantings until Owner’s acceptance at Substantial Completion. Maintenance operations shall include: watering, mulching, tightening or adjusting of tree stakes, resetting plants to proper grade, fertilization and weeding. Contractor shall commission the irrigation system prior to acceptance. Replacement materials shall meet all specifications of original materials.

All plant materials shall look vibrant and healthy. Plants that look weak, sickly, or unhealthy will be refused and shall be replaced by Contractor at Contractor’s expense. Owner shall have option of inspecting plants prior to purchase. Plant material to conform to the standards set forth in the *American Standard for Nursery Stock*.

Installers shall loosen or break up root balls on all plants, trees, shrubs, etc. prior to inserting into planting holes. All root ball binding materials shall be removed before planting, including all twine, all wire, and top 2/3 of burlap minimum. No soil is to cover the top of the rootball. Contractor will be required to reset plants if too low.

Trees shall be guaranteed for 2 full years following Substantial Completion. During the warranty period, the Contractor is recommended to hand water evergreen material after irrigation system is winterized. In order to maintain health trees, it is recommended the Contractor check evergreens biweekly during the winter, to determine water needs, unless there is snow accumulation or ground is frozen. All other plant materials, including sod and native grass areas, shall be guaranteed for 1 full year following substantial completion. Replacement material to be subject to original warranty period starting on the day the replacement planting is approved by Owner. The warranty period resets with replacement material planting(s). Replacement material shall be replaced at Contractors’ expense.

Part 2 - Products

Planting pits: Provide 50% organic amendment/imported topsoil and native soil in all planting pits to improve soil structure and improve nutrient content. Pits to be two times wider and 6” deeper than root ball.

Perennial and groundcover beds: 18” depth planters mix (imported topsoil with 3cy/1000 s.f. organic amendment thoroughly tilled in.

Sod: 12” depth, consisting of lower 6” tilled native soil with 3 cy/1000 s.f. organic amendment, and upper 6” imported topsoil with 3 cy/1000 s.f. organic amendment.

Section
Number Title

Native grass areas: if no depth/amendment is specified, conduct nutrient and soils analysis to determine required imported soils and amendments.

Provide organic amendment and topsoil data, including source, material composition, and pH, to Owner (landscape architect) for approval. Material shall be composted, well-rotted, free of refuse and containing not more than 25% straw or other bedding material.

A routine nutrient and texture soils analysis, with recommendations for amendments from a soils lab, is required to determine additional additives, including fertilizers and organic soil amendments, that may be required for turf, native grass and plant establishment. Soil-Testing Laboratory Qualifications: An independent laboratory with the experience and capability to conduct the testing indicated and that specializes in types of tests to be performed. Submit to landscape architect for approval.

Tree stakes shall be three (3) inch diameter by eight (8) feet long Lodgepole Pine, free of any weakening knots or other defect, driven 3' into undisturbed soil. Stake deciduous trees 3" caliper and larger and evergreen trees 6' tall and larger with 2-3 stakes equidistantly spaced in direction of prevailing wind. Allow 6" play in wire for staking. NAU representative to remove stakes after 1 year.

Guy wire shall be new, 2 strands 12 gauge, annealed, galvanized.

Chafing guards shall be new, 16" x 3" canvas strap with brass grommets and heat finished edges. Do not use rubber hose.

Sod shall be cut, delivered and installed (remove plastic mesh from sod rolls) within a 24-hour period. Cultivate subgrade to a depth of 6" prior to placing clean topsoil and remove all construction material, stones and debris 1" and greater in diameter. Place topsoil to a depth of 6" over cultivated subgrade.

Planting Bed Mulch and Mulch at Tree Basins in Lawn Areas: Shredded Western Red Cedar. Bulk sources only; bagged material not permitted. Submit sample and source to campus landscape architect for approval prior to delivery to site. Place to a depth of 4" thick at all planting beds. Adjust thickness of mulch at perennials to 2" to avoid burying foliage. Top of mulch to be flush with adjacent finish grades. Do not install with weed fabric or plastic. Do not use at retention or detention basins, areas with high velocity runoff, high wind areas, or slopes greater than 3:1.

Gravel: ½" or 1" screened 'Rock Springs Chocolate' or 'Table Mesa Brown'

Section
Number Title

crushed rock. Place 4" thick, without weed fabric or plastic. Limited use on campus; only to be used at planting beds where flammability or high-wind is an issue, or at unplanted locations only as approved by campus landscape architect. Do not use at retention or detention basins, areas with high velocity runoff, or slopes greater than 3:1.

Rip-Rap: 3"-6" diameter 'Rock Springs Chocolate' or 'Table Mesa Brown' crushed rock. Visually screen rip-rap areas with high density planting. Limit use to areas where erosion will occur if rock is not used and stormwater cannot be slowed using other methods.

Soil Rip-Rap: 3"-6" diameter 'Rock Springs Chocolate' or 'Table Mesa Brown' crushed rock mixed with topsoil installed 12" thick. Use 65% rip-rap and 35% topsoil by volume, uniform mixture without voids. To be used in conjunction with shortgrass and tallgrass meadow blends at drainage swales and steep slopes.

Boulders: limestone, approximately 3' diameter or of ledgestone shape and size. Rock color to match existing limestone on campus. Basalt not permitted. Coordinate use of campus limestone stockpiles with Landscaping & Outdoor Services and campus landscape architect. To be buried 1/3 for natural effect and placing naturalistically to appear as outcroppings. Use only in select locations as approved by Owner (landscape architect).

Part 3 - Execution

Where plant material will be placed in soil beneath existing pavement, especially asphalt pavement, or other condition where soil sterilant or other treatment potentially harmful to plant material may have been applied, area shall be tested for the presence of any such chemicals or condition. Affected soils shall be treated and/or excavated and disposed of in accordance with local codes.

Areas to receive groundcover or perennial plants shall be excavated in their entirety to 18" below finish grade and filled with clean topsoil mix described above.

Planting pit percolation rates to be determined prior to planting in the presence of Owner (Landscaping and Outdoor Services) representative. Where applicable, percolation tests may be required to prove drainage. If pit (filled with water) does not drain in 30 minutes, inform landscape architect to determine adjusted location or correction of drainage condition.

After water settling backfill, set trees and shrubs 1" above adjacent finish grade. Top of root ball for perennials, groundcover and grass plugs to be flush with

Section
Number

Title

finish grade. Scarify planting pit sides.

Construction debris and rocks larger than 1" shall be completely removed from site and shall not be buried in mulch beds.

Where existing lawns have been damaged by construction they shall be repaired by the Contractor, via resodding or refurbishment per the Owner's discretion/direction. Resodding shall include loosening and tilling compacted soil to a min. 9" depth, and removal of contaminated soil, and debris and rock larger than 1". Rototill organic amendment (3 cy/1000 s.f.) into top 6" layer of native soil. Refurbishment shall include aerating, topdressing with ½" organic amendment, and overseeding with bluegrass/rye blend approved by NAU Landscaping and Outdoor Services. Contractor is required to provide a seed bag tag submittal for review and approval prior to installation which includes at a minimum the Purity %, Test Date, Germination Rate, and Weed Seed Content. Repaired/resodded areas must be fenced for protection from trampling at installation.

Maintenance for new or reestablished turf areas shall be as follows:

- Maintenance period shall be for 2 mowings or an agreed upon time frame depending on season of the year. New sod shall be mowed in ½" increments.
- Spray heads shall be initially set at finish grade of soil **BEFORE** sod installation. During the warranty period additional height adjustments by the Contractor at no additional cost may be required once turf is established. Irrigation shall not result in wilting, puddles or runoff.
- After 3 weeks, fertilize with a fertilizer that provides one-pound available Nitrogen per 1000 sf.
- Final acceptance will occur with a satisfactory stand of grass (solid, healthy growth, without bare spots) at the end of the maintenance period.
- Berms and swales shall be formed as continuous, smooth landforms with no obvious top or bottom to slopes or grade change from berm to swale.
- Provide positive drainage away from buildings and structures. Direct runoff water to planting areas.

32 91 00 Planting Preparation

32 91 13 Soil Preparation

Part 1 – General

Section
Number Title

Submit sands soil analysis (for pH levels) for material to be used at LID basins for Owner's (Landscaping and Outdoor Service's and landscape architect's) review and approval.

Part 2 – Products

Topsoil

Topsoil shall be friable, loam topsoil, free from construction materials, sticks, stones over 1" in diameter, roots, refuse, noxious weeds or any other material toxic to plant growth. Topsoil is subject to inspection and acceptance by Owner (landscape architect and Landscaping & Outdoor Services), accompanied by required soils analysis.

Shall have:

- Loam and soil texture (USDA classification)
 - 30% to 50% sand
 - 10% to 25% clay
 - 30% to 50% silt
- pH. - 6.0 - 7.5

All in-place soil and topsoil shall be free from nut grass, refuse, roots, noxious weeds, or any material toxic or a hindrance to plant growth.

Unless otherwise specified, all in-place and/or imported soil will be prepared and conditioned as topsoil to meet the following minimum specifications:

- pH shall not exceed 7.5 or be lower than 6.0
- Manure as a soil conditioner/amendment must be fully aged a minimum of two years.

Organic amendment

Organic soil conditioner product shall be certified as fully composted and contain no solid particle greater than ½" in length or diameter, and be free from uncomposted and non-stabilized wood bulking agents. Provide soil conditioner analysis to Owner (landscape architect and Landscaping & Outdoor Services) three (3) weeks prior to delivery to site.

Part 3 – Execution

The Contractor is required to furnish the Owner at no additional cost, a routine soils texture and nutrient analysis, with recommendations from the soils laboratory for the type of landscape to be installed (sod, native grass, perennials, trees and shrubs) for native soil, imported topsoil, and organic amendment (composted soil conditioner) which will include at a minimum:

- Nitrogen

Section
Number

Title

- Phosphorus
- Potassium
- Sodium absorption
- pH
- Percentage of sand, silt, clay, organic matter, water holding capacity

Landscape or planting areas shall not be cultivated when they are so wet as to cause excessive compaction or so dry as to cause excessive dust or the formation of large clods.

If imported soil is specified, the existing soil shall be roto-tilled to a minimum depth of 6 inches prior to placing topsoil. All clods and rocks over 1 inch in diameter, within 6 inches of the surface, shall be removed and disposed of offsite. The thickness of the topsoil shall be at least 6 inches.

****END OF SECTION****

Section Number Title

32 92 00 TURFS AND GRASSES

Part 1 – General

Lawns may only be specified where maintainable with full normal access (no inner courtyards not directly accessible from outside) for irrigation, mowing, fertilizing, and pest control operations.

Lawn areas shall be designed open and clutter free to maximize usability and simplicity, absent of boulders or other items.

Planting beds shall be separated from lawns and native grass areas by concrete edger, MAG Type ‘B’ curb, 6” wide x 12” depth, modified to be flush with finish grade, standard gray (no color or pigment).

Bluegrass blend turf shall not be used in any planting strip less than 36" wide.

Lawn soil surfaces shall be constructed 1” below walks, curbs, mow strips or other adjacent paving to allow for sod root base.

Any valve boxes installed in turf areas shall be made flush with the finish grade not turf blade height.

32 92 16 Native Grass Plugging

Part 1 - General

At high visibility areas, native grass plugs to be specified in conjunction with hydroseeding to reduce establishment period of short and tall grass meadows.

Submit seeding operations and grass plug planting schedule to Owner (campus landscape architect and Landscaping & Outdoor Services) for approval. If seeding/planting operations do not occur during July when natural monsoon moisture and warm temperatures are present, hand watering and/or a turf-type annual rye nurse crop may be required. Hand watering frequency required would be three (3) times per week for one (1) month to root in plugs and germinate seed if monsoons are not active with sufficient moisture.

Weed control in all native grass meadow areas shall be addressed by the Contractor before project acceptance at Substantial Completion. Weed control shall be accomplished by hand-pulling. Herbicide may only be used in cases of a weedy infestation, and only if approved by Owner (Landscaping & Outdoor Services and landscape architect).

Part 2 – Products

Section
Number Title

Tall Meadow Mix – grass plugs

Botanical Name	Common Name
<i>Festuca arizonica</i>	Arizona Fescue

Short Meadow Grass – grass plugs

Botanical Name	Common Name
<i>Bouteloua gracillas</i>	Blue Grama

Part 3 – Execution

Plant plugs 12” on center, triangular spacing, throughout area, in addition to hydroseed mix. Hydroseed to be applied prior to plugging.

32 92 22 Hydroseeding

Part 1 - General

Submit seeding operations schedule to Owner (campus landscape architect and Landscaping & Outdoor Services) for approval. If seeding operations do not occur during July when natural monsoon moisture and warm temperatures are present, hand watering and/or a turf-type annual rye nurse crop may be required. Hand watering frequency required would be three (3) times per week for one (1) month to root in plugs and germinate seed if monsoons are not active with sufficient moisture.

Weed control in all native grass meadow areas shall be addressed by the Contractor before project acceptance at Substantial Completion. Weed control shall be accomplished by hand-pulling. Broadleaf herbicide may only be used in cases of a weedy infestation, following first application of seeding, and only if approved by Owner (Landscaping & Outdoor Services and campus landscape architect).

Native grass areas should be full stands, 98% weed free. Bare areas to be overseeded prior to project acceptance at Substantial Completion.

Part 2 – Products

Tall Meadow Blend

Botanical Name	Common Name	% of Blend
<i>Bouteloua gracillas</i>	Blue Grama	40
<i>Blepharonuron trichloepis</i>	Pine Dropseed	10
<i>Bouteloua curtipendula</i>	Side Oats Grama	15
<i>Festuca arizonica</i>	Arizona Fescue	10
<i>Koeleria macrantha</i>	Prairie Junegrass	10

Section
Number

Title

<i>Muhlenbergia rigens</i>	Deer Grass	10
<i>Panicum virgatum</i>	Switch Grass	5

Short Meadow Blend

Botanical Name	Common Name	% of Blend
<i>Bouteloua gracillas</i>	Blue Grama	50
<i>Festuca idahoensis</i>	Idaho Blue Fescue	10
<i>Festuca ovina</i>	Sheep’s Fescue	10
<i>Muhlenbergia montana</i>	Mountain Muhly	10
<i>Poa fendleriana</i>	Mutton Grass	10
<i>Sporobolus crytandrus</i>	Sand Dropseed	10
<i>Bouteloua dactyloides</i>	Buffalo Grass	

Add Buffalograss (*Bouchloe dactyloides*) to short meadow blend for high traffic areas. When adding Buffalograss, use 30% Buffalograss at 6 lbs/acre, 30% Blue Grama and evenly distribute remaining varieties in the mix.

Riparian Grass Blend for PLD (LID) Basins (seasonal moisture)

Botanical Name	Common Name	% of Blend
<i>Bouteloua gracillas</i>	Blue Grama	40
<i>Festuca arizonica</i>	Arizona Fescue	20
<i>Muhlenbergia rigens</i>	Deer Grass	20
<i>Muhlenbergia wrightii</i>	Spiked Muhly	20
For areas with year-round moisture, add:		
<i>Carex aquatillis</i>	Water Sedge	10
<i>Carex microptera</i>	Smallwinged Sedge	10

For areas with year-round moisture, reduce Blue Grama to 30% with even proportions of remaining species.

Sow meadow mixes at 8-10 lb/acre; obtain seeding rates from seed supplier based on percentage of mix listed.

Refer to Landscape Master Plan, Principles and Design Standards, for perennials that can be added to short and tall grass blends, and riparian blend in high visibility areas. Use equal proportions of perennials added.

Part 3 – Execution

Where soil amendments are incorporated or imported topsoil is required, soil shall be thoroughly rototilled and fine graded prior to seeding operations. Where native soil is an acceptable growing medium, hand rake native seed areas to disturb soil prior to seeding operations.

Section Number	Title
-------------------	-------

Hydroseed mix to include native seed mix as specified, wood fiber mulch, plant, cellulose-based trackifier (plantago or equal), and 3-2-1 organic fertilizer at a rate of 1.5 LB nitrogen/1000 s.f. In small areas where hydroseeding is not practical, treat with ½” layer of organic matter raked into to 2” of disturbed soil, cover with 1” layer of organic mulch after seeding. Apply 3-2-1 fertilizer watered in.

A second seeding application may be necessary to ensure adequate control of weedy species between seeding applications.

32 92 23	Sodding
----------	---------

Part 1 - General

Sod is required at new turf areas; seeding bluegrass areas is not acceptable to establish new lawns.

Warranty sod for a period of one (1) year from date of acceptance. During warranty period, replace sod that has died or is in unsatisfactory condition.

Contractor is to notify Owner of any new sod plantings.

Part 2 – Products

Sod shall be Arizona-grown bluegrass rye mix blend having a healthy, vigorous root system. Blend shall contain a minimum of two (2) improved bluegrass varieties. Sod shall be tolerant of drought, sun to shade and foot traffic is preferred. Sod soil base to be similar to NAU campus soil types. Sod grown on a sandy loam soil will not be accepted. Owner has pre-approved the following source to be in compliance with these standards (due to similar soil base): Northland Sod in Chino Valley. Alternative sources are to be submitted to Owner (landscape architect) for approval. Sod with excessive weed content will be rejected.

Sod is subject to inspections and acceptance. Owner reserves the right to reject at any time prior to acceptance, any work and sod which in the Owner’s opinion fails to meet the requirements herein. Rejected sod shall be promptly removed and replaced at Contractor’s expense.

Sod shall be healthy, thick turf having undergone a program of regular fertilization, mowing and weed control; free of objectionable weeds; uniform in green color, leaf texture and density; healthy, vigorous root system; inspected and found free of disease, nematodes, pests and pest larvae.

Section
Number Title

Each piece of sod shall have a soil base that will not break, crumble, or tear during installation. Root base shall be 1” thick. Thatch not to exceed ½” compressed. Sod shall be cut in strips or slabs no more than twenty-four (24) hours prior to delivery.

Deliver inorganic or chemical fertilizer(s) to site in original unopened container bearing manufacturer’s guaranteed chemical analysis, name, trade name, trademark, warranty and conformance to state law.

New imported topsoil shall be fertile natural loam and subject to inspection and acceptance by Owner (landscape architect), accompanied by required soils analysis.

Organic soil conditioner product shall be certified as fully composted and contain no solid particle greater than ½” in length or diameter, and be free from uncomposted and non-stabilized wood bulking agents. Provide soil conditioner analysis to Owner (landscape architect and Landscaping & Outdoor Services) three (3) weeks prior to delivery to site.

Use selective herbicides, insecticides and fungicides as approved by Owner and adhere to local environmental laws.

Part 3 – Execution

Landscape contractor to verify site conditions are specified prior to beginning sodding work. Report unsatisfactory conditions in writing to General Contractor and Owner. Beginning of installation means acceptance of conditions.

The soil shall be thoroughly rototilled and fine graded to receive the grass. Contractor shall request a DP inspection on the grading, to be submitted to Owner. If there is no DP on the project, Contractor shall request an inspection from Owner.

All sod must be in place prior to September 15th and warranty must be provided for one (1) year from the date of Substantial Completion.

Sod shall be delivered on pallets with root systems protected from exposure to sun, wind, and heat in accordance with standard practice and labeled with botanical and common name of each grass species in accordance with federal seed act.

Sod to be protected from dehydration, contamination and heating at all times. Store sod moist and under shade or covered with moistened burlap. Do not drop sod rolls or slabs from carts, trucks, or pallets. Do not stack more than 24” deep.

Section
Number

Title

Install sod within twenty-four (24) hours of delivery. Remove soil base netting/mesh from rolls.

Import and place any fill material required to adjust the fine grade to meet drainage requirements or to match adjustment surface fine grades. Soil levels shall be 1" down from adjacent grades. Remove weeds, debris, and rocks larger than ½" which may hinder sodding. Dispose of debris off-site. Provide smooth, well-countered surface prior to sod installation.

Adjust irrigation heads and valve boxes to be flush with finish grade (not turf blade height).

Install sod between spring and fall: April 15th – September 15th. Do not install on frozen or saturated soil.

Soil which is laid shall be slightly moist. Lay sod with longest dimension parallel to contours and in continuous rows. Tightly butt ends and sides of sods together. Stagger rows by 2' minimum and compact vertical joints between strips or slabs so sod will be incorporated into ground surface, ensuring tight joints between pieces. Sod shrinkage is grounds for rejection.

When soil and sod are moist, hand-roll sod lightly as soon as possible after laying. Ensure positive drainage of storm and irrigation water will occur without ponding after sod installation.

Protect sodded areas against damage from pedestrian and vehicular until acceptance by Owner.

Evenly distribute soil conditioner at a rate of 3 c.y. per 1,000 S.F.

First application of fertilizer to sodded areas shall be starter fertilizer applied per manufacturer's recommendations. Water turf thoroughly following applications.

Remove annual weeds by tilling and perennial weeds by applying herbicide one (1) week before soil preparation and as needed, but no sooner than three (3) after emergence. Contractor to provide seventy-two (72) hour notice prior to application.

Rip to a minimum 6" depth after rough grading has been established. In area where extremely stiff material or rock is encountered, re-adjust depth to avoid bringing up chunks of untillable material.

Compact grade at sod areas to 80% SPD with 2% optimum moisture.

Section
Number Title

Maintenance period shall begin immediately after each area is sodded and continue until Final Completion of entire project. During this time, be responsible for watering, mowing, fertilizing, spraying, weeding, aerating and all related work as necessary to ensure that sodded area is in a vigorous growing condition. Furnishing all supervision, labor, material and equipment to maintain turf areas.

Initially water sod upon completion until the irrigation system can be operated under full control. Water sod sufficiently to moisten subsoil at least 4" deep.

Mow to maintain turf at 2 ½" height. Do not remove more than 33% of grass leaf in single mowing. Remove clippings from pavement areas.

Resod spots larger than 1 s.f. not having healthy, uniform stand of grass and resod or overseed (using like for like soil) joints which separate ½" or more.

32 93 00 Plants

Part 1 – General

Unless otherwise approved by Owner, minimum sizes for material as follows:

- Deciduous trees: 2" caliper
 - Aspen shall be single stem, no multiples
- Evergreen trees 6'-8' height
- Shrubs and ornamental grasses: 5 gallon
- Perennials 1 gallon

Refer to Landscape Master Plan for complete list and description of plant materials for each character zone. Design Professionals shall not specify or permit the substitution of materials that do not appear on the approved lists, unless approved by campus landscape architect.

Plant Non-Availability: In order to request a substitution of plant material the Contractor must submit in writing a request for plant substitution including a list of a minimum of (3) major nurseries which indicated they could not supply the specific plant material at the specified size. The Contractor shall suggest a substitution for a different size of the specified plant or different variety of species, including its size and root condition. Requests for substitution will be reviewed and a written response provided by the Design Professional and/or campus landscape architect. The Contractor shall not proceed with ordering or installing any requested substitutions until receipt of written approval is received.

Section
Number Title

Owner reserves the right to inspect and choose trees, shrubs, and other plantings in the nursery field or some other site prior to planting. Provide at least five (5) working days written request for inspection prior to the proposed date.

Owner has the option of acceptance or rejection of any plant materials deemed unacceptable upon delivery to the site.

Plant installation processes and maintenance after planting shall be reviewed by Owner. Any plants not installed according to campus standards must be removed and re-installed. Follow Owner standard planting details.

Warranty

Trees shall be guaranteed by Contractor for minimum two years after substantial completion. All other plant materials to be guaranteed for one year. At any time during the warranty period, the Contractor shall remove or replace, without cost to the Owner, all plants not in a healthy and flourishing condition as determined by the Owner or Design Professional.

Replacement plants shall be subject to the same specified requirements, including adherence to original duration of the warranty.

Include the following remedial actions as a minimum:

- Immediately remove dead plants and replace unless required to plant in the succeeding planting season.
- Replace plants that are more than 25% dead or in an unhealthy condition at end of warranty period.

Planting Plans

Planting plans shall graphically depict tree sizes canopies at 75% maturity, with no more than 30% overlap between canopies to allow sufficient space for growth and uptake of water and nutrients. Represent shrub, perennial, and ornamental grass plantings at 90% maturity (within approximately three years of planting).

Planting design shall achieve minimum 80% coverage on the ground plane after three-four year establishment period. Use staggered or triangular plant spacing (avoid linear patterns). Evergreens and winter interest plants shall comprise 30-50% of the planting palette. Seasonal interest to include year-round color and structure, with particular emphasis on fall, winter and spring seasons.

Section
Number Title

Concrete header to be used for planting bed borders where they abut turf or native grass meadow areas. In instances where concrete header is not practical (i.e. installation would damage existing tree roots), planting beds shall have a 45 degree, 6 inch deep shovel-cut edge. Do not use metal or plastic edging.

Refer to Landscape Master Plan Principles and Design Standards for special areas, i.e. parking screening, accent areas, and for North, Central, and South campus character zone principles.

Part 2 – Products

Quality Assurance

All plants shall be healthy, true to species and variety/hybrid/cultivar specified, and nursery-grown in accordance with good horticultural practices and under climatic conditions similar to those of campus. Material to meet full size of specifications (no recent shifts to larger container), and shall conform to American Standard for Nursery Stock and standard specifications for height, width, caliper and grade specified.

Trees and shrubs shall be trained in development and appearance as to be superior in form, compactness and symmetry. Trees with multiple leaders, unless specified otherwise, and shrubs with damaged or cut main stem(s), will be rejected.

Trees and shrubs with a damaged, cut or crooked leader, abrasion of bark, sunscald, frost crack, disfiguring knots, insects (including eggs and larvae) or insect damage, cankers/cankerosus lesions or fungal mats, mold, prematurely-opened buds, or cuts of limbs over 3/4” (1.9 cm) diameter that are not completely callused will be rejected.

Trees and shrubs shall have healthy, well-developed root systems, and be free from physical damage or other hindrances to healthy growth.

Balled and burlapped plants shall be dug with solid balls of a diameter not less than that recommended by the American Standards for Nursery Stock, and of sufficient depth to include both fibrous and feeding roots. Balls shall be securely wrapped with burlap, and tightly bound with rope or twine. No plant shall be bound with rope or wire in such manner as to damage bark or break branches. The root flare should be within the top 2” (5.1 cm) of the soil ball.

Balled and burlapped plants will not be accepted if the ball is dry, cracked, or broken before or during planting.

Section
Number Title

Containerized plants are to be well-established within the container, with a root system sufficiently developed to retain its shape and hold together when removed from the container. Soil within the container should be held together by the roots, in form and whole. Plants shall not be pot-bound, nor have kinked, circling, or bent roots.

Bare root plants are to have a healthy, well-branched, and adequately spreading root system characteristic of the species.

Measurement

Plants shall conform to the measurements specified within the contract documents. Specified height and spread dimensions will refer to the main body of the plant, and not from branch tip to branch tip. Plants meeting a specified measurement, but judged to lack the balance between height and spread characteristic of the species will be rejected.

Plants shall be measured when branches are in their normal position.

No plant shall be less than the minimum size specified, and no less than fifty (50) percent of the plants shall be as large as the maximum size specified.

Measure the trees and shrubs with their branches, canes, and trunks in their normal position. Take height measurements from or near the top of the root flare for field-grown stock and container grown stock. Measure main body of tree or shrub for height and spread; do not measure branches or roots tip to tip. Take caliper measurements 6 inches above the root flare for trees up to 4-inch caliper size, and 12 inches above the root flare for larger sizes.

Containerized shrubs shall be measured by height and width for conformity with the plant list.

Perennials shall be measured by pot size, not by top growth.

All other measurements, such as number of canes, ball sizes, and quality designations, shall conform to *American Standards for Nursery Stock*.

Plant List

Refer to Landscape Master Plan for complete list (species and varieties) of plant materials for each campus character zone. Genuses are listed below for perennials, ornamental grasses, shrubs, and trees.

Deciduous Trees

Section
Number

Title

Botanical Name

Acer
Amelanchier
Celtis
Crataegus
Fraxnus
Gleditsia
Gymnocladus
Populus
Prunus
Quercus
Robinia
Sorbus
Ulmus
Populus

Common Name

Maple
Serviceberry
Hackberry
Hawthorn
Ash
Honeylocust
Kentucky Coffee Tree
Aspen
Cherry
Oak
Locust
Ash
Elm
Cottonwood

Evergreen Trees

Botanical Name

Abies
Picea
Pinus
Pseudotsuga
Sequoiadendron
Juniperus

Common Name

White Fir
Spruce
Pine
Douglas Fir
Sequoia
Juniper

Deciduous Shrubs

Botanical Name

Amelanchier
Aronia
Caryopteris
Cornus
Cotoneaster
Ligustrum
Lonicera
Philadelphus
Potentilla
Prunus
Prunus
Prunus
Rhus
Ribes
Rosa
Spiraea

Common Name

Serviceberry
Chokeberry
Spirea
Dogwood
Cotoneaster
Privet
Honeysuckle
Mockorange
Cinquefoil
Sand Cherry
Almond
Cherry
Sumac
Currant
Rose
Spirea

Section
Number

Title

Symphoricarpos
Syringa
Viburnum
Amorpha
Holodiscus

Coralberry
Lilac
Viburnum
Leadplant
Mountain Spray

Evergreen Shrubs

Botanical Name

Juniperus
Mahonia
Pachystima
Picea
Pinus
Chamaebatiaria

Common Name

Juniper
Oregon Grape Holly
Mountain Lover
Spruce
Mugo Pine
Fernbush

Ornamental Grasses

Botanical Name

Andropogon
Calamagrostis
Carex
Festuca
Helictotrichon
Miscanthus
Panicum
Bouteloua
Muhlenbergia
Muhlenbergia
Blepharoneuron
Poa
Schizachyrum
Sorghastrum
Sporobolus

Common Name

Big Bluestem
Feather Reed Grass
Sedge
Fescue
Blue Avena Grass
Maiden Grass
Switch Grass
Blue Grama
Deergrass
Muhly
Dropseed
Muttongrass
Little Bluestem
Indian Grass
Alkali Sacaton

Perennials

Botanical Name

Achillea
Agastache
Aquilegia
Aster
Callirhoe
Calylophus
Centranthus
Cerastium

Common Name

Yarrow
Hyssop
Columbine
Aster
Winecups
Sundrops
Red Valerina
Snow in Summer

DIVISION 32 – EXTERIOR IMPROVEMENTS

Section Number	Title
	<i>Ceratostigma</i>
	<i>Clematis</i>
	<i>Coreopsis</i>
	<i>Delphinium</i>
	<i>Echinacea</i>
	<i>Erigeron</i>
	<i>Gaillardia</i>
	<i>Galium</i>
	<i>Geranium</i>
	<i>Hemerocallis</i>
	<i>Heuchera</i>
	<i>Iris</i>
	<i>Lavandula</i>
	<i>Leoucanthemum</i>
	<i>Lupinus</i>
	<i>Monarda</i>
	<i>Nepeta</i>
	<i>Oenothera</i>
	<i>Papaver</i>
	<i>Parthenocissus</i>
	<i>Penstemon</i>
	<i>Phlox</i>
	<i>Potentilla</i>
	<i>Ratibida</i>
	<i>Rubbeckia</i>
	<i>Salvia</i>
	<i>Saponarai</i>
	<i>Stachys</i>
	<i>Tanacetum</i>
	<i>Thalictrum</i>
	<i>Thymus</i>
	<i>Veronica</i>
	<i>Vitis</i>
	<i>Zaushneria</i>
	<i>Arctostaphylos</i>
	<i>Hedera</i>
	<i>Geum</i>
	<i>Heuchera</i>
	<i>Iberis</i>
	<i>Lonicera</i>
	<i>Mahonia</i>
	<i>Paxistima</i>
	<i>Penstemon</i>
	Plumbago
	Westen Virgin’s Bower
	Coreopsis
	Delphinium
	Coneflower
	Fleabane
	Blanket Flower
	Sweet Woodruff
	Geranium
	Daylily
	Coral Bells
	Iris
	Lavender
	Shasta Daisy
	Lupine
	Bee-Balm
	Catmint
	Primrose
	Poppy
	Virginia Creeper
	Beardtongue
	Phlox
	Cinquefoil
	Coneflower
	Blacked-Eyed Susan
	Salvia
	Rock Soapwort
	Lamb’s Ear
	Partridge Feather
	Meadow Rue
	Thyme
	Speedwell
	Canyon Grape
	Hummingbird Flower
	Kinnikinnick
	English Ivy
	Prairie Smoke
	Coral Bells
	Candy Tuft
	Honeysuckle
	Mahonia
	Mountain Lover
	Penstemon

DIVISION 32 – EXTERIOR IMPROVEMENTS

Section
Number

Title

<i>Teucreum</i>	Germander
<i>Thymus</i>	Thyme
<i>Veronica</i>	Speedwell
<i>Vinca</i>	Periwinkle
<i>Akebia</i>	Akebia
<i>Akebia</i>	Chocolate Vine
<i>Clematis</i>	Western Virgin's Bower
<i>Hedera</i>	English Ivy
<i>Lonicera</i>	Honeysuckle
<i>Parthenocissus</i>	Virginia Creeper
<i>Vitis</i>	Canyon Grape
<i>Asclepias</i>	Butterfly Weed
<i>Castilleja</i>	Paintbrush
<i>Eriogonum</i>	Buckwheat
<i>Erysimum</i>	Wallflower
<i>Fragaria</i>	Wild Strawberry
<i>Gaura</i>	Whirling Butterflies
<i>Helianthus</i>	Maximillian's Sunflower
<i>Ipomopsis</i>	Scarlet Gilia
<i>Litras</i>	Gayfeather
<i>Linanthastrum</i>	Mountain Phlox
<i>Linum</i>	Blue Flax
<i>Lithospermum</i>	Stoneseed
<i>Machaeranthera</i>	Aster
<i>Monardella</i>	Mint
<i>Oxytropis</i>	Locoweed
<i>Pseudocymopterus</i>	Mountain Parsley
<i>Saponaria</i>	Rock Soapwort
<i>Senecio</i>	Groundsel
<i>Solidago</i>	Goldenrod
<i>Thermopsis</i>	Golden Banner
<i>Veronica</i>	Speedwell
<i>Viola</i>	Violet
<i>Prairie Zinnia</i>	Paper Flower
<i>Antennaria</i>	Pussytoes
<i>Polygonum</i>	Silver Lace Vine
<i>Aurinia</i>	Allysum
<i>Origanum</i>	Oregano
<i>Santolina</i>	Lavender Cotton
<i>Scabiosa</i>	Pincushion Flower

Refer to Section 32 92 16 (Plugging) and 32 92 22 (Hydroseeding) for Tall and Short Meadow Grasses.

Section
Number Title

Part 3 – Execution

All plants and trees shall be identifiable to Owner to verify species with the plant tag. All plant tags, pricing, identifiers, and care labels to be removed by Contractor at Substantial Completion.

All trees must be installed prior to September 15 to allow one month of irrigation prior to winterization.

An on-site mockup stake layout of planting bed areas and trees shall be approved by Owner and Design Professional prior to installation.

Trees located in turf lawns (existing and proposed) shall be provided with four foot diameter mulch rings, with sod free soil beyond and around the full circle of the tree, excluding large existing trees, upon approval from Owner. Tree groupings (existing and proposed) within lawn areas may have one large mulch planting bed around them.

Preferred distance for deciduous trees from paved surfaces (walks and mowing edges) is six feet (3' minimum with approval by campus landscape architect). Evergreen trees to be planted no closer than two feet greater than the anticipated mature radius of branching from paved surfaces.

Maintain access to manholes for equipment and/or safety gear when locating new trees and other plantings. Location of new trees from the centerline of sanitary and storm sewer utilities to be as follows:

- Deciduous ornamental trees: 6' minimum
- Deciduous shade trees: 8' minimum
- Evergreen trees (full size): 10' minimum
- Dwarf variety evergreen trees: 6' minimum

Aspen trees should not be planted in lawn areas and should be five feet minimum from paved surfaces. Clump or multi-stem form aspen not permitted.

Plant material planted in rows shall be uniform in size and shape.

Trees and shrubs shall not be planted until all construction working the area has been completed, final grades established, the planting areas properly graded and prepared as specified.

Existing Plant Material

To minimize disruption and protect existing tree roots, the guidelines below shall be followed:

Section
Number Title

- Locate poles, conduit, boxes 10’ min. from tree trunk for large mature trees such as Elm.
- Locate poles, conduit, boxes 6’ min. from tree trunk for smaller mature trees such as Crabapple.
- Never cut roots within 2’ of tree trunk. Cutting of just one buttress root within 2’ of tree reduces stability strength by 25%, making tree a liability even if it survives.
- Ideal tree protection is the entire dripline (full canopy diameter). Majority of roots (80%) are in the top 2’ of soil.

Temporary Protection

Contractor to provide temporary fencing, barricades or guards during construction to protect from damage existing trees, lawn, and other plants which are designated to remain on site with green colored “cyclone” or “snow” fencing.

Protect root systems by not storing construction materials, debris, or excavated material within five (5) feet of the drip line of the tree (outer perimeter of the branches). Do not permit vehicle traffic within outer perimeter of the branches and restrict foot traffic to prevent excessive compaction of the soil over root systems.

Repair and Replacement of Existing Trees, Shrubs and Lawn

Repair trees, shrubs and lawns damaged by construction in a manner acceptable to the Owner. Make repairs promptly after damage occurs to prevent progressive deterioration of damaged trees, shrubs, and lawns.

Remove and replace dead and damaged trees, lawns, and shrubs, which are determined by the Owner to be incapable of restoration to normal growth patterns. Damaged plants, lawns or grass areas shall be replaced and treated as required to conform with specifications herein for fresh stock.

Replace existing damaged and dead plant material with same size and species. Plant, maintain, and warranty as specified under landscaping section of the specifications. Use campus standard planting details. Cover disturbed planting bed area with 4" of mulch and restore back to preconstruction conditions.

For any trees requiring replacement due to neglect by the Contractor that have a caliper greater than 4", a penalty per tree will be assessed. Penalty will be assessed at the value identified by Owner’s tree software, or, if not identified in the software, at fair market value. The penalty shall be in addition to the required replacement planting.

Section
Number

Title

32 96 00 Transplanting

Part 1 – General

Salvage of existing trees from a project shall be performed by a firm approved by Owner with at least four years of experience with this type of work. The work shall be guaranteed and conducted in a manner consistent with local practice. Owner shall designate a holding area and source of irrigation for containerized or otherwise temporarily stored trees. Owner has first right of refusal for all plantings or materials removed or transplanted from the site. Contractor is required to provide the Owner (Landscape and Outdoor Services and Project Manager) a minimum 72 hours' notice prior to any site removals or anticipated transplants and salvages.

Part 2 – Products

No specific products included.

Part 3 – Execution

Transplanting of plant materials shall be consistent with Section 32 90 00 (Planting) and the execution section of Section 32 91 00 (Planting Preparation).

****END OF SECTION****

Section Number	Title
33 00 00	UTILITIES
33 10 00	WATER UTILITIES
33 11 00	Water Utility Distribution Piping
33 11 16	Site Water Utility Distribution Piping
33 11 50	Reclaimed Water Distribution System
33 12 00	Water Utility Distribution Equipment
33 12 13	Water Service Connections
33 30 00	SANITARY SEWERAGE UTILITIES
33 31 13	Public Sanitary Utility Sewerage Piping
33 40 00	STORM DRAINAGE UTILITIES
33 41 13	Public Storm Utility Drainage Piping
33 50 00	FUEL DISTRIBUTION UTILITIES
33 51 13	Natural Gas Piping
33 60 00	HYDRONIC AND STEAM ENERGY UTILITIES
33 61 13	Chilled Water Distribution System
33 61 33	Hydronic Energy Distribution Metering
33 63 20	Steam and High Temperature Hot Water Tunnels
33 70 00	ELECTRICAL UTILITIES
33 71 00	Electrical Utility Transmission and Distribution
33 71 39	High Voltage Wiring (Above 600-Volt)
33 71 73	Electrical Utility Services
33 71 73.33	Electric Meters
33 73 00	Utility Transformers
33 80 00	COMMUNICATION UTILITIES
33 81 00	Communication Structures
33 81 26	Communications Underground Ducts, Manholes, and Handholes
33 82 00	Communications Distribution
33 82 01	Switching Center Terminations
33 82 13	Copper Communications Distribution Cabling
33 82 23	Optical Fiber Communications Distribution Cabling

Section Number	Title
33 00 00	UTILITIES

Part 1 - General

Owner (NAU Utility Services & Trade Personnel), in conjunction with the DP firm, shall establish the connection point for each required service during schematic design and before design development.

The DP shall submit hydraulic calculations for each utility system in the BOD along with each design phase submittal.

Utility shutdowns must be done in accordance with procedures in Division 1.

Inspection Process:

1. The individual Owner Trades will inspect the components that they are responsible for on the FS#15.
2. The components listed on the FS#15 for the Locating Services need to be inspected by the Owner's Locating Supervisor on every utility. Locating Services will check as-builts as part of the shading/backfill inspections.
3. Meters need to be inspected by the Owner's Trade department responsible for the utility and the Owner's EMS Coordinator prior to any insulation and energization of the system.
4. The Owner's Director of Utilities must sign the FS#15 prior to utilities being energized. At no time is a Contractor to energize a distribution line or building feed without approval from the Owner (Director of Utilities).
 - a. For distribution lines, the Contractor will need to provide the individual inspection reports (FS#15A) of numbers 1-3 in the process and as-builts for the utility. Refer to Division 1 for surveyed as-built requirements.
 - b. For building feeds, the Contractor will need to show signoff of the appropriate line in Sitework and Utilities on the FS#15, the individual inspection reports for Locating Services, Metering and interior inspections; and updated as-builts for the utility. The Contractor also must have requested an in service meter inspection.
5. An additional meter inspection is required to review the meters for accuracy after the individual utility system is energized. The Contractor will have 1 week to respond to any accuracy issued found and an additional week to make any corrections. If corrections are not made at the end of the 2-week period Owner may de-energize the utility in question until satisfactory progress is made.
 - a. If the Contractor is unable to correct the issue in the specified time, Owner may hire another contractor to fix the issue and back charge the failed Contractor.

Section
Number Title

Shading around all utility pipe shall be constructed as follows:

	Bottom	Sides	Top
Chilled Water	6"	6"	12"
Sewer	6"	6"	12"
Gas	8"	8"	8"
Domestic Water	6"	6"	12"
Electrical	6"	6"	6"
Storm Drain	6"	6"	12"

Locator Wire

Locator wire is required on all utility installations. It shall be 12 AWG solid copper wire, PVC insulated, type UF, UL listed for direct burial in ground. Wire shall be installed continuously (without interruption/splicing) on the surface of the pipe, except for locator wire for natural gas shall be in the first lift of shading. When connecting to existing tracer wire, splicing system shall consist of a copper wire crimp, PVC split case gland, and epoxy waterproof sealing compound.

Trace wire shall be required on all newly installed utilities that extend outside of the building to the point where contract boundaries end. If tying into an existing utility and that utility will not come above ground, (tying into an existing sewer line, for example), then the trace wire shall be brought to the surface and terminated in a box directly above the newly installed utility. Sanitary sewer and storm sewer manholes shall have a tracer wire j-box within the manhole ring. Box lids shall be marked "trace wire", and what utility the trace is for. If a utility comes above ground then the trace wire shall come above ground with the same utility in valve cans, manholes, junction boxes, box pads. For components that come above ground without a junction box or box pad (fire hydrants, etc.) shall have the tracer wire terminated in a box next to those components. In concrete and asphalt, the boxes shall be valve cans. In landscape areas, the boxes shall be 6" diameter or less green irrigation boxes. Installation is required to be inspected and signed off on the FS#15.

Tracer wire damaged during excavation will be repaired to the satisfaction of the Locator Supervisor and be included in the inspection signoffs.

Section
Number

Title

Utility Markers

Survey Markers

Utility survey markers will be required on all new construction projects and renovation/replacement projects that do not have existing markers placed directly above the utility line. On exterior walls where the utility enters the building the marker shall be installed 1' above finished grade with the wording parallel to the ground and not upside-down. Cast/wet set in the top of curbs on both sides of a street/pedway when within a project boundary with the wording parallel to the utility flow direction. Owner may request markers be placed in other locations on new construction, renovation or on concrete replacement projects. Owner will provide the survey markers on new marker locations.

Building, utility and concrete renovation projects may run into existing survey markers. The Contractor is required to preserve the markers, reset the existing markers or replace the marker if damaged during removal. Owner will not provide replacement survey markers.

Other Utility Markers

Valve can, manhole, and pullbox lids for utilities shall be installed with the appropriate utility name (Water, Gas, Electric, Telecom, ETC.)

Verification of marker location requires signoff on the FS#15 prior to substantial completion.

General Utility Meters

Utility meters shall be designed and specified by the Design Professional. Contractor shall furnish and install all utility meters. Utility meter commissioning shall be a joint effort between the Contractor, Design Professional, Commissioning Agent (where applicable), and the Owner. Owner will not energize any utility until the meter has been shown to be fully functioning and operational.

Design and construction documents to specify, schedule and require furnishing, installing, and commissioning of all utility meters. Documents shall include a flow meter schedule that explicitly defines:

- Utility service
- Meter type
- Meter size
- Maximum, minimum and normal Flow range
- BTU range
- Temperature and pressure

Section
Number Title

Design documents shall include meter installation details that are complete and include all necessary information, including, but not limited to, length of straight pipe required upstream and downstream, distance required from valves or fittings, any required concentric reducers and location of temperature and pressure sensors.

Utility meters shall be specified to provide a local readout- either in transmitter head or in a suitably rated box on an adjacent wall. In either case, meter readout shall be designed to be readily accessible- between 4’ and 5’6” AFF.

Utility meters shall communicate with Owner’s campus Energy Management System (EMS), which is Alerton. Specify all necessary components and communication protocols to assure meter information can be mapped to Owner’s building EMS web page.

All gas and steam flow meters shall be temperature and pressure compensating.

Part 2 – Products
N/A

Part 3 – Execution

The supply of any utility to a building shall not be activated until the specified metering is in place, functional, and has been commissioned.

During the final phase of the project and before Final Completion, Contractor shall be required to prove that all utility meters are installed properly and function as designed and specified. The utility meter commissioning shall be accomplished by the Contractor in conjunction with the Design Professional, Commissioning Agent (where applicable) and the Owner.

Calibration data, O & M manuals, details, etc., to be submitted after meters accepted.

Existing Plant Material/Temporary Protection
See Division 32 93 00, Section 3 - Execution

33 11 00 Water Utility Distribution Piping

33 11 16 Site Water Utility Distribution Piping

Part 1 - General

Section
Number

Title

This section defines the general design parameters for the water distribution system, including domestic and fire protection water distribution, service lines, fire hydrants and system appurtenances.

The Design Professional (DP) shall conduct a Fire Flow test at the project site. Tests shall be performed by the Owner and witnessed by the Owner's Fire Marshal.

Refer to Division 21 for fire requirements.

Design and construction of all water systems shall comply with the rules and regulations of the Arizona Department of Environmental Quality (ADEQ), the Arizona Administrative Code (ACC), and MAG Standards.

The Design Professional (DP) shall size the piping system based on the design flows. Coordinate with the Project Manager and Director of Utilities regarding existing flows and pressures within the system and provisions for future campus expansion and additional demands in the system.

Part 2 – Products

All materials that will come in contact with potable water shall conform to ANSI/NSF Standard 61 and the rules and regulations of the Arizona Department of Environmental Quality.

Chlorination shall be separate for all site piping and building infrastructure.

All material used in the construction of Fire Service lines shall conform to NFPA 13 and NFPA 24. All material shall conform to the requirements of Underwriter's Laboratory (UL) or Factory Mutual (FM), and listed.

Polyvinyl Chloride (PVC) Pipe 4-inch diameter to 12" diameter shall conform to AWWA C900, Class 200 (SDR 14) and cast iron outside diameter. Elastomeric gaskets shall conform to ASTM F477 providing a watertight seal when tested in accordance with ASTM D3139. Fittings used on PVC pipe shall be mechanical joint ductile iron (DI) fittings as specified below.

Ductile Iron Pipe

Ductile Iron Pipe (DIP): All pipes shall be push-on Tyton joint, mechanical joint (MJ) joint or integral restrained joint ductile iron pipe. The pipe shall be manufactured and tested in accordance with the American Water Works Association (AWWA) Standard C151, and have working pressure (pressure class) of not less than:

Section
Number

Title

accordance with AWWA C502, dry barrel fire hydrants. Hydrants shall be traffic type with break-a-way flange unit installed just above grade.

Tapping Sleeves shall conform to MAG Specification No. 630 with prior approval from the Owner (Plumbing department). Sleeves shall be ductile iron or fabricated from ¼-inch (minimum) ASTM 286 Grade C steel or ASTM A-36 steel. Sleeves shall be factory coated with corrosion resistant epoxy in accordance with AWWA C550. Flange shall be 150 LBS MSS-SP60. Bolts shall be corrosion resistant, high strength, low –alloy, per AWWA C-111. Gasket shall be Burna-N or neoprene. Sleeves shall be rated for 250 psi. Tapping sleeves shall be furnished with a 3/4 inch test plug. Plug shall be bronze NPT, coupling shall be epoxy coated.

Backflow Assemblies shall be reduced pressure backflow assemblies conforming to AWWA C511 and approved by the Foundation for Cross-Connection Control and Hydraulic Research at the University of Southern California. Assemblies shall have OS&Y resilient seated gate valves and shall be epoxy coated per AWWA C550. Assemblies shall be installed in buildings unless approved by Owner’s Plumbing Supervisor. If exposed to the elements then it must be protected from freezing. Owner has pre-approved the following backflow assemblies to be in compliance with these standards: reduced model Wilkons XL 975.

Couplings used on ductile iron and PVC C900 pipe shall be ductile iron, solid sleeves with mechanical joints, complying with AWWA C110 and C111 and as specified for ductile iron fittings. Couplings shall be fully restrained.

Air Relief Valves shall be vacuum and air relief valves shall be of the size shown on the plans. Corporations shall be full opening with O-ring seal and bronze ball and conform to AWWA C800. Taps into ductile iron pipe may be made by direct tapping of the pipe or with a service saddle. Taps into PVC pipe shall be made with a service saddle. Service saddles shall conform to AWWA C800, and be constructed of bronze or epoxy coated ductile iron. Saddles shall have a single or double strap. The outlet of the valve shall be equipped with a gooseneck and stainless steel screen as indicated on the drawings. Copper tubing shall be Type K, ASTM B88.

All valves underground or in vaults shall be gate valves.

Joint Restraint Devices

All joints, fittings, and valves within the system shall be fully restrained.

Ductile iron fittings mechanical style joints - EBAA Iron Sales, Inc. “Mega Lug” joint restraint or approved equal. The specific model utilized shall be compatible with the type of pipe (DIP or PVC) connected to the fitting.

Section
Number

Title

PVC pipe push-on style joints – EBAA Iron Sales Series 1600, or approved equal.

Ductile iron push-on style joints – EBAA Iron Sales Series 1700, or approved equal.

Ductile iron pipe and PVC integral joint restraint type - U.S. Pipe “TR Flex” restrained joint pipe and fittings. Pacific States Thrust-Lock.

Integral joint restraint type - U.S. Pipe “TR Flex” restrained joint pipe and fittings, Pacific States “Thrust Lock” joint system, Griffin Pipe “Snap Lok” joint system, or approved equal.

Thrust blocks shall be used in conjunction with joint restraint devices and constructed according to MAG standards.

The use of gaskets with integral restraint grippers shall not be permitted.

Valve Boxes and cover shall consist of a cast iron box and cover and PVC riser. The valve box and cover casting shall be manufactured in conformance with ASTM A48, Class 30B. Cover shall be labeled “Water”, and paint box blue. Valve can risers shall have a debris cap with a color handle applicable to the designated utility.

Valve stem risers shall comply with Maricopa Association of Governments Uniform Standard Specifications and Details for Public Works Construction Standard Specification No. 610 and as detailed on the plans.

Polyethylene Encasement (DI Pipe) shall conform to AWWA C105. The color of the polyethylene encasement shall be black or blue.

Part 3 – Execution

General

Fire service lines shall be installed in accordance with NFPA 13 and NFPA 24.

Minimum depth of cover, measured from top of pipe, shall be as follows:

Water Mains: 42-inches

Fire Service Mains: 42-inches (12-inches below frost depth).

In order to energize water to a building the Contractor must have U3, U5 and U6 on the FS#15 signed, and an approved FS#15A for B1-B3 and C6 for the water system.

Section
Number

Title

Pipe and Fittings

Do not make the connections to the existing system until such time that the system has been cleaned; flushed, disinfected, and all hydrostatic testing has been completed and accepted.

All work associated with modifications to the water system, fire service lines, and building service lines shall be carried in an expeditious manner to minimize the time frame during which the water supply to the campus facilities and building automatic fire sprinkler system is impacted. No water main or service line shall be taken out of service until all piping, fittings, and appurtenances, required to complete the system modifications and return the system to operating condition, are available on the project site.

PVC pipe shall be installed in accordance with the requirements of AWWA C605, the manufacturer's recommendations and Maricopa Association of Governments Uniform Standard Specifications and Details for Public Works Construction Standard Specification No. 610, and as specified herein.

Ductile-Iron Pipe

Install in accordance with the recommended procedures set forth in AWWA C600 and Maricopa Association of Governments Uniform Standard Specifications and Details for Public Works Construction Standard Specification No. 610, and as specified herein.

The maximum allowable joint deflection will be as given in AWWA C600, AWWA C605. If the alignment required deflection in excess of the above limitations, special bends or a sufficient number of shorter lengths of pipe shall be utilized to provide angular deflections within the limits set forth.

Install all joint restraint devices in accordance with the manufacturer's instructions and prior to pressure testing of the system. Do not bend or deflect the pipe.

All piping shall be fully restrained.

Install all valves in accordance with the manufacturer's instructions. When the top of the operating nut is 4 feet or greater below finish grade, install a valve nut extension.

Install air relief valves at high points.

Cleaning and Flushing

Section
Number

Title

It shall be the responsibility of the Contractor to keep the lines clean of all foreign materials during construction. Flush lines per ADEQ Rules and regulations.

The system shall be flushed at a minimum of 2.5 FPS for a minimum of 60 seconds per 100 feet of pipe. Water used for flushing shall be potable water.

Should dirt, debris, and/or foreign material be allowed to accumulate in the lines, the Contractor shall be responsible to remove all such material from the line by flushing the lines or other approved methods. In the event that such measures are required, the Contractor shall provide a written proposal to the Owner stating the methods to be utilized. In review of the proposal, the Owner will consider the potential for adverse impacts on the Campus.

Disinfection

Disinfect all lines per ADEQ rules and regulations. Disinfect all lines per ADEQ Engineering Bulletin No. 8.

The Contractor shall submit a disinfecting plan to the Owner's review. The plan shall detail the method for disinfecting the system and identify the certified laboratory that will sample and perform the microbiological testing. The Contractor shall be responsible for the cost of all laboratory testing.

Separation between Potable Water Mains and Sewers/Reclaimed Water Mains

Per ADEQ rules and regulations.

Hydrostatic testing shall conform to AWWA C600 / C605 at a test pressure of 200 PSI, modified as follows.

Allowable Leakage Determination: During the 2 hour, 200 PSI pressure test, the makeup water to maintain the test pressure within 5 psi of the test pressure and re-pressurize the system to the starting pressure shall be measured. Leakage is defined as the quantity of water to be supplied into the newly laid pipe, or approved section thereof, necessary to maintain the specified leakage test pressure after the pipe has been filled with water and the air expelled. No piping installation will be accepted until the leakage is less than the number of gallons per hour as determined by the formula:

$$L = 0.00013 * N * D * (P \text{ raised to } 1/2 \text{ power})$$

In which L equals the allowable leakage in gallons per hour; N is the number of joints in the length of pipeline tested; D is the nominal diameter of the pipe in inches; and P is the average test pressure during the leakage test, in psi gauge. Should any test of pipe disclose leakage greater than that specified in the

Section
Number Title

foregoing table, the defective joints shall be located and repaired until the leakage is within the specified allowance, without additional cost to the Owner.

The Contractor shall provide certified test pressure gauges, calibrated within 8 months of the test. The gauges shall be a minimum of 4-inches in diameter, with a 1-psi scale.

After installation of the tapping sleeve and valve and prior to making the tap, the sleeve shall be tested at 200 psi for 2 hours. There shall be no pressure drop during the test period.

System Connections

Unless specifically approved by the Owner in writing, connections to the existing system shall be made only after all pipes have been disinfected and all hydrostatic testing have been approved by the Owner.

Where utility access hatches/vaults/manholes are installed within 2 feet of sidewalks, they shall be 1 inch below top of finished sidewalk to accommodate snow removal without damage to boxes or lids.

Where utility access hatches/vaults/manholes are installed in sidewalks, patios, roadways, or any other structure where snow removal shall occur, the top of the access hatches shall be a minimum of ¼” and a maximum of ½” below finished surface of concrete to accommodate for snow removal without damage to boxes or lids.

33 11 50 Reclaimed Water Distribution System

Part 1 – General

This Section includes the following for direct buried reclaimed water distribution systems, including mains, service lines, pipe, fittings, valves, and joint Restraint.

The Design Professional (DP) shall size the piping system based on the design flows. The maximum velocity in the system shall be 5 feet per second. Coordinate with the Project Manager the existing flows and pressures within the system and provisions for future campus expansions. Submit calculations to the Project Manager.

Valves, install valves on three sides of all tees and four sides of all crosses. Maximum spacing between valves shall not exceed 300 feet.

Part 2 – Products

Section
Number

Title

Refer to Domestic Water standards for products but use Reclaimed designations for installation.

Part 3 – Execution

Minimum depth of cover, measured from top of pipe, shall be as follows:

Reclaimed water mains: 42-inches

Reclaimed water service lines: 36-inches

In order to energize water to a building the Contractor must have U3, U7 and U8 on the FS#15 signed and an approved FS#15A for B1-B3 and C6 for the reclaimed water system.

Pipe and Fittings

PVC pipe shall be installed in accordance with the requirements of AWWA C605, the manufacturer's recommendations and Maricopa Association of Governments Uniform Standard Specifications and Details for Public Works Construction Standard Specification No. 610, and as specified herein.

Ductile-Iron Pipe: Install in accordance with the recommended procedures set forth in AWWA C600 and Maricopa Association of Governments Uniform Standard Specifications and Details for Public Works Construction Standard Specification No. 610, and as specified herein.

The maximum allowable joint deflection will be as given in AWWA C600, AWWA C605. If the alignment required deflection in excess of the above limitations, special bends or a sufficient number of shorter lengths of pipe shall be utilized to provide angular deflections within the limits set forth. Do not bend or deflect the pipe.

Install all joint restraint devices in accordance with the manufacturer's instructions and prior to pressure testing of the system.

All piping shall be fully restrained.

Install all valves in accordance with the manufacturer's instructions. When the top of the operating nut is 4 feet or greater below finish grade, install a valve nut extension as detailed on the drawings.

Install air relief valves at high points.

Install locator wire to the top of the all water line. The Contractor shall minimize the number of splices in the wire. All splices shall be made with a watertight gland.

Section
Number Title

Concrete Encasement

The Contractor shall coordinate with the Owner if the existing main can be depressurized during concrete encasement work. The Contractor shall adjust their schedule to correspond with the approved shut down period. In the event that the existing system cannot be depressurized, the Contractor shall construct the encasement in segments that allows the system to remain in service. Prior to placing the concrete the existing joints in the existing system shall be exposed and inspected under system pressure. Any leaks or damage to the existing pipe shall be repaired prior to placing concrete.

The Contractor shall install all required temporary supports required to support the existing piping while excavating around the pipe. If the existing pipe is deflected or damaged during construction, the Contractor shall replace all deflected and damaged piping.

Filling System, the pipe shall be filled with potable water or from the existing reclaimed water system.

It shall be the responsibility of the Contractor to keep the lines clean of all foreign materials during construction. All lines shall free of debris and soil materials. Should soil, sand, debris, and/or foreign material be allowed to accumulate in the lines, the Contractor shall be responsible to remove all such material from the line by flushing the lines or other approved methods. In the event that such measures are required, the Contractor shall provide a written proposal to the Owner stating the methods to be utilized. In review of the proposal, the Owner will consider the potential for adverse impacts on the Campus.

Separation between Reclaimed Water Mains and Potable Water Mains

The minimum separation between potable water mains and reclaimed water mains shall be six (6) feet vertically, with the water main above the reclaimed water line, and six (6) feet horizontally, unless extra protection is provided. In no case shall the reclaimed water main be placed within one (1) foot vertical or horizontal of a water main.

Extra protection shall be mechanical joint ductile iron pipe, restrained joint push on ductile iron pipe, or concrete encasement of the pipe within a minimum of 6-inches of concrete on all sides of the pipe.

Where reclaimed water lines crosses above or less than six (6) feet below a water line, or within 6-feet horizontally of a water main, the reclaimed water line shall be constructed of mechanical joint ductile iron pipe for a distance of ten (10) feet on either side of the water main crossing, or both the water and the reclaimed water main shall be concrete encased.

Section
Number Title

The horizontal and the vertical dimensions shall be measured from outside of pipe to outside of pipe.

Comply with ADEQ’s Rules and regulations.

Hydrostatic testing shall conform to AWWA C600 / C605 at a test pressure of 200 PSI, modified as follows:

Allowable Leakage Determination: During the 2 hour, 200 PSI pressure test, the makeup water to maintain the test pressure within 5 psi of the test pressure and re-pressurize the system to the starting pressure shall be measured. Leakage is defined as the quantity of water to be supplied into the newly laid pipe, or approved section thereof, necessary to maintain the specified leakage test pressure after the pipe has been filled with water and the air expelled. No piping installation will be accepted until the leakage is less than the number of gallons per hour as determined by the formula:

$$L = 0.00013 * N * D * (P \text{ raised to } 1/2 \text{ power})$$

In which L equals the allowable leakage in gallons per hour; N is the number of joints in the length of pipeline tested; D is the nominal diameter of the pipe in inches; and P is the average test pressure during the leakage test, in psi gauge. Should any test of pipe disclose leakage greater than that specified in the foregoing table, the defective joints shall be located and repaired until the leakage is within the specified allowance, without additional cost to the Owner. The Contractor shall provide certified test pressure gauges, calibrated within 8 months of the test. The gauges shall be a minimum of 4-inches in diameter, with a 1-psi scale.

After installation of the tapping sleeve and valve and prior to making the tap, the sleeve shall be tested at 200 psi for 2 hours. There shall be no pressure drop during the test period.

System Connections

Unless specifically approved by the Owner in writing, connections to the existing system shall be made only after all pipes have been disinfected and all hydrostatic testing have been approved by the Owner.

33 12 00 Water Utility Distribution Equipment
33 12 13 Water Service Connections
Part 1 – General
Domestic and Reclaim Water Meter

Section
Number Title

Positive displacement meter with pulse counter and totalizing head.

Specify compound meter where necessary to manage high (maximum – minimum) turn down. Owner has pre-approved the following manufacturer to be in compliance with these standards: Onicon meter.

Part 2 – Products

N/A

Part 3 - Execution

Meter EMS Displays: Displays within the EMS for meters shall include the following when applicable:

- Domestic Water: Flow in GPM, totalized in gallons. Peak flow rate with the date and time that point was reached.
- Reclaimed Water: Flow in GPM, totalized in gallons. Peak flow rate with the date and time that point was reached.
- All maximum and minimum values shall have a button to reset when those values were tracked from. Multiple meters may be required to record maximum and minimum flows. Trends on flow rate and totalized energy must be setup within the EMS prior to substantial completion.

****END OF SECTION****

Section Number	Title
33 30 00	SANITARY SEWERAGE UTILITIES
33 31 13	Public Sanitary Utility Sewerage Piping

Part 1 – General

This section defines the general design parameters for the sanitary sewer collection system, including pipe and fittings, service lines, manholes and system appurtenances.

General Design Considerations:

Minimum velocity when flowing full, and a Manning n=0.013.

Normal reaches 2.5 feet per second.

Terminal reaches 3.0 feet per second.

Maximum wet weather flow shall not exceed 0.75 percent of the pipe diameter.

Minimum Pipe Diameter:

Mains 8-inch.

Terminal reaches less than 200 feet 6 inch.

Service lines 4 inch.

Manholes:

Install manholes at horizontal deflection points, grade changes, all sewer main line junctions, and at all building service lines 6-inch or larger.

Install water tight covers on manholes that may be subject to surface stormwater flows.

Install bull horn clean out no more than 5' from building.

The maximum spacing between manholes shall not exceed 350 feet.

Do not use curvilinear sewers.

The Design Professional (DP) shall size the piping system based on the wet weather peak design flows. Coordinate with the Project Manager regarding existing flows within the system and provisions for future upstream campus expansions. Submit flow and hydraulic calculations to the Project Manager.

The Design Professional (DP) shall design a Flow Management Plan (FMP) when the construction restricts the flow in the existing system. The FMP shall detail all

Section
Number

Title

temporary bypass pumping facilities required to maintain continued sewer service to the upstream users.

Pipe lining and other in-situ rehabilitation shall be coordinated with the Project Manager.

Design of all sanitary sewer system shall comply with the rules and regulations of the Arizona Department of Environmental Quality (ADEQ) and the Arizona Administrative Code (ACC).

Part 2 – Products

All sanitary sewer piping, manholes and fittings shall conform to the Maricopa Association of Governments Uniform Standard Specifications and Details for Public Works Construction and the rules and regulations of the Arizona Department of Environmental Quality.

Polyvinyl Chloride (PVC) Pipe, ASTM D-3035, SDR-35 minimum, pipe and fittings shall have integral bell gasketed joint, gaskets shall conform to ASTM F-477.

Ductile Iron Pipe

Push-on Tyton joint, mechanical joint, epoxy lined. Rubber gasket joints shall be in accordance with AWWA C111. Epoxy lining shall be a Hybrid novolac epoxy lining system a minimum of 40 Mil thick.

Manholes shall be precast concrete riser sections conforming to ASTM 478, with cast in place concrete base. Minimum manhole diameter shall be 5-feet. Frames and covers shall be cast iron with a minimum diameter of 24-inches. Frame and covers shall be labeled “Sanitary Sewer”. All manholes shall have steel reinforced polypropylene steps.

Couplings shall be epoxy coated steel barreled, compression styled couplings, sized for the OD of the pipe.

Polyethylene encasement for ductile iron pipe shall conform to AWWA C105. Color shall be black or green.

Part 3 – Execution

General Installation, install system in accordance with the Maricopa Association of Governments Uniform Standard Specifications and Details for Public Works Construction and the rules and regulations of the Arizona Department of Environmental Quality (ADEQ).

Section
Number

Title

When connecting directly into a City of Flagstaff sewer line, the Contractor is responsible for obtaining City of Flagstaff permit. Confirm with Owner on what is a City of Flagstaff or an Owner utility line (if not identified on the plans).

Minimum depth of cover, measured from top of pipe, shall be as follows;

Sewer Mains: 48-inches.

Service Lines: 36-inches

General Installation

Install manholes at horizontal deflection points, grade changes, all sewer main line junctions, and at all building service lines 6-inch or larger.

Where utility access hatches/vaults/manholes are installed within 2 feet of sidewalks, they shall be 1 inch below top of finished sidewalk to accommodate for snow removal without damage to boxes or lids.

Where utility access hatches/vaults/manholes are installed in sidewalks, patios, roadways, or any other structure where snow removal shall occur, the top of the access hatches shall be a minimum of ¼” and a maximum of ½” below finished surface of concrete to accommodate for snow removal without damage to boxes or lids.

Do not use curvilinear storm sewers.

During all periods when flow is restricted within the existing sanitary sewer system, the Contractor shall erect all provisions of the Flow Management Plan (FMP) and provide 24-hour per day maintenance for the pumping and force main equipment. All pumping equipment shall have redundant capacity. All pumping equipment used shall be set in a containment area acceptable to the Owner.

Report all Sanitary Sewer Overflows (SSO’s) immediately to the Owner. The Contractor shall be responsible for containing and cleaning up all SSO’s.

The Contractor shall not allow the release of silt, soil or other debris into the existing sewer system. If material is released into the existing system, the Contractor shall be solely responsible for cleaning the existing system.

Testing

Section
Number

Title

Test lines and manholes per the Maricopa Association of Governments Uniform Standard Specifications and Details for Public Works Construction and per ADEQ Rules and regulations. Testing shall include, but not limited to the following:
Vacuum testing of manholes, and structures per ASTM C1244.

Low pressure air testing of pipe lines per MAG Standard Specification 615.
Deflection testing of all mains per ASTM D-3034.
Lamp testing of mains.

The Owner requires closed circuit television (CCTV) inspections of the sewer by the Contractor upon substantial completion. The DVD shall be required as part of the closeout package.

Separation Between Sanitary Sewers and Water Mains

The minimum separation between potable water mains and sanitary sewers shall be two (2) feet vertically, with the water main above the sanitary sewer, and six (6) feet horizontally, unless extra protection is provided. In no case shall the sewer main be placed within one (1) foot vertical or horizontal of a water main.

Extra protection shall be mechanical joint ductile iron pipe, restrained joint push on ductile iron pipe, or concrete encasement of the pipe within a minimum of 6-inches of concrete on all sides of the pipe.

Where water lines crosses above or less than two (2) feet above a sewer main line, or within 6-feet horizontally of a water main, the sanitary sewer or the water mains shall be constructed of mechanical joint ductile iron pipe for a distance of ten (10) feet on either side of the water main crossing, or both the water and the sewer main shall be concrete encased.

The horizontal and the vertical dimensions shall be measured from outside of pipe to outside of pipe.

Per ADEQ Rules and regulations.

****END OF SECTION****

Section Number	Title
33 40 00	STORM DRAINAGE UTILITIES
33 41 13	Public Storm Utility Drainage Piping

Part 1 – General

There are areas of Owner's campus that are in the FEMA flood plain and flood way zones. Refer to a current FEMA map for locations. Any work within these areas must be reviewed and approved by the FEMA flood plain manager.

General Design Considerations

Minimum velocity when flowing full, and a Manning $n=0.013$.

Mains 2.0 feet per second

Terminal reaches 2.5 feet per second

Minimum pipe diameter.

Mains 18-inch diameter.

Laterals less than 40 feet 12 inch diameter.

Storm Drains shall be designed to convey the 10 year storm event.

Hydrologic and hydraulic calculations shall be based on City of Flagstaff MHDUD (Manual for hydraulic Design for Urban Drainage)

The hydraulic grade line shall be computed at all junctions. At all inlet junctions the hydraulic grade line shall be within the limits set forth in the MHDUD (City of Flagstaff Manual for hydraulic Design for Urban Drainage).

The design flow and the hydraulic grade line shall be shown on the storm drain profile for each reach of the system.

Storm drainage piping, manholes catch basins, and junction structures shall be design for AASHTO HS20 wheel loads, and the design dead loads.

Part 2 – Products

General, all piping, manholes, catch basins and fittings shall conform to the Maricopa Association of Governments Uniform Standard Specifications and Details for Public Works .

Polyvinyl Chloride (PVC) Pipe and Fittings, ASTM D-3035, SDR-35 minimum, pipe and fittings shall have integral bell gasketed joint, gaskets shall conform to ASTM F-477.

High Density Polyethylene (HDPE) and Fittings, profile-reinforced and corrugated (Type S or Type D) pipe manufactured per ASTM F-894, AASHTO M-252 or AASHTO M-294 for gravity flow, low pressure storm drain systems. Pipe and fittings shall have gasketed joints.

Section
Number

Title

Reinforced Concrete Pipe (RCP) and Fittings, ASTM C76, Class III, or ASTM C655, D-load as indicated on the Drawings. Rubber gaskets shall conform to ASTM 765.

Corrugated Metal Pipe (CMP), AASHTO M-36, galvanized. Steel thickness shall be indicated on the drawings. Band clamps shall be dimpled. O-rings shall comply with ASTM C 361, Section 5.9 and shall be placed on the first corrugation of the pipe end and compressed by the band clamp.

Spiral Rib Corrugated Steel Pipe (CSP), Pipe shall be ALUMINIZED steel, Type 2, helically wound, with 3/4 by 3/4 by 7-1/2 inch rectangular ribs projecting outwards from the pipe wall and continuous lock seams. The ALUMINIZED steel shall conform to ASTM 929 or AASHTO M274. The pipe shall be manufactured in accordance with ASTM A760 or AASHTO M36. Pipe connected with band clamps shall be manufactured with a minimum of two annular re-rolled corrugations for the purpose of joining pipe together. Steel thickness shall be indicated on the drawings. Joints shall be bell and spigot with fluted gaskets, or band clamps with O-rings gaskets. The bell and spigot and band clamps shall be manufactured of ALUMINIZED Type 2 steel. Band clamps shall comply with AASHTO M-36, manufactured of material two gages thinner than the pipe. Band clamps shall be dimpled. O-rings shall comply with ASTM C 361, Section 5.9 and shall be placed on the first corrugation of the pipe end and compressed by the band clamp.

Ductile Iron Pipe (DIP) and Fittings, Ductile Iron Pipe (DIP): All pipes shall be push-on Tyton joint, mechanical joint, epoxy, lined. Rubber gasket joints shall comply with AWWA C111.

Manholes shall be cast in place concrete or precast concrete riser sections conforming to ASTM 478, with cast in place concrete base. Minimum manhole diameter shall be 4-feet for pipes 18-inches and smaller, 5 feet diameter for pipe between 18 and 36 inch diameter, and the pipe diameter plus 18-inches for pipe larger than 36 inches. Frames and covers shall be cast iron with a minimum.

Catch Basins and Inlets, cast in place concrete, conforming to the Maricopa Association of Governments Uniform Standard Specifications and Details for Public Works Construction. Grates shall be welded steel, galvanized. Grates in pedestrian walkways shall conform to ADA requirements.

Precast junction structures shall be manufactured in accordance with ASTM C-478. Structures shall be sized as indicated on the Drawings. The design of the precast structure shall be include the design penetrations in the structure. Frames and covers shall be cast iron with a minimum diameter of 24-inches.

Section
Number

Title

Transition couplings shall be special manufacture of piping material or shall be a concrete collars conforming to MAG Standard Detail No. 505. Concrete shall be Class A, 3,000 PSI, reinforcement shall be Grade 40. Transition couplings on pipe 12-inches diameter or smaller may be mission style couplings.

Part 3 – Execution

General

Install per the Maricopa Association of Governments Uniform Standard Specifications and Details for Public Works Construction and as specified below.

Install manholes at all changes of slope or pipe deflections.

Do not use curvilinear storm sewers.

During all periods when flow is restricted within the existing storm drainage system, the Contractor shall provide all required temporary conveyance measures to ensure that flooding or hazardous conditions do not occur upstream or downstream of the project.

The Contractor shall not allow the release of silt, soil or other debris into the existing storm drainage system. If material is released into the existing system, the Contractor shall be solely responsible for cleaning the existing drainage system.

Minimum depth of cover, measured from top of pipe, shall be as follows:

Storm sewer mains: 36-inches.

Storm sewer laterals: 24-inches.

Testing

Test all manholes, and structures per ASTM C1244.

Test all piping in accordance with MAG Standard Specification No. 615.

Separation between storm sewers and potable water mains shall be 12 inches minimum.

****END OF SECTION****

Section
Number

Title

33 50 00 FUEL DISTRIBUTION UTILITIES

33 51 13

Natural Gas Piping

Specifications included below apply to internal and external gas piping.

Part 1 – General

NAU is considered an Owner Operator and all Arizona Corporation Commission (ACC) rules and regulations shall apply.

The gas distribution systems and gas service lines shall be constructed of welded steel pipe or High density polyethylene (HDPE). Plastic and copper pipe shall not be used in the gas piping system.

Design and construction shall be in accordance with the Code of Federal Regulations (CFR): Title 49, Chapter 1, Part 192, Transportation of Natural and Other Gas by Pipeline – Minimum Safety Standards, and codes referenced herein.

Cathodic protection shall be designed and constructed for all underground gas piping. The design shall be in accordance with National Association of Corrosion Engineers (NACE) International standards. All calculations, design and testing shall be performed by or supervised by the Corrosion Specialist or Engineer.

Part 2 – Products

Underground Piping

Black Steel, seamless or ERW, ASTM A53, Grade B, Schedule 40 (minimum), factory coated and protected with cathodic protection, U.S. domestic made pipe.

Shop-applied pipe coating shall be one of the following types:

Shop-applied pipe coating: Fusion Bonded Epoxy (FBE) meeting the requirements of AWWA C213. Coating thickness shall be a minimum of 14 mil base coat and 15 mil top coat. Repair of the coating shall be per the coating manufacturer's written instructions.

Adhesive-Thermoplastic Resin Coating: Fed. Spec. L-C-530, Type I.

Adhesive-thermosetting Resin Coating: Fed. Spec. L-C-530, Type II.

Field-applied plastic tape material for use on pipe joints and for repairing damaged areas of shop-applied coatings shall conform to Federal Spec. L-T-1512,

Section
Number

Title

Type I, 250 μm (10 mils) nominal thickness for pipe joints, and Type II, 500 μm (20 mils) nominal thickness for coating repairs.

All gas lines into building need to have insulating unions installed to isolate building pipe from underground piping.

Fittings

Steel Pipe Fitting:

Butt weld fittings shall be wrought steel, ANSI B16.9.

Socket weld fittings shall be forged steel, 2,000 PSI Class, ANSI B16.11.

Threaded fittings shall be malleable iron, ANSI 16.3 or forged steel, ANSI B16.11.

Flanges shall be steel, Class 150, ANSI B16.5.

Joints

Socket or butt welded for steel pipe, ANSI B31.8. Threaded joints not permitted except at above grade. Flanged joints at valve connections.

Control Valves

Valves 2-inches and larger shall be lubricated plug valves, semi steel, carbon steel, or cast iron, flanged connections conforming to API 6D.

Valves 1.5-inches and smaller shall be lubricated plug valves, semi steel or cast iron, screwed or but welded connections conforming to API 6D.

Direct buried valves shall have a 2-inch operating nut.

Tapping valves shall be cylindrical lubricated plug valves with 100 percent full pipe area, round port.

Valves shall be rate for a minimum working pressure 125 PSI and be tested and certified by the manufacturer.

Taps

Fully welded weld-o-let or welded fittings.

Valve Can

Valve can covers shall consist of cast iron box and riser. All valve can covers shall include a debris cap. The valve box and cover casting shall be manufactured in conformance with ASTM A48, Class 30B. Covers shall be labeled "GAS".

Section
Number

Title

Meters

Owner has pre-approved the following product for gas meters to be in compliance with these standards: ONICON F-5000 Series Thermal Mass Flow Meters.

Meters shall comply with ANSI B109.2. Meters shall be pipe or pedestal mounted. Meters shall be provided with over-pressure protection as specified in ASME B31.8, tamper-proof protection, frost protection. Meters shall be suitable for accurately measuring and handling gas at pressures, temperatures, and design maximum and minimum flow rates.

Meters shall have direct reading indexes (cubic feet) and safe pulse output for remote reading. Output from meter shall be compatible with, and connected to, the Building Management System (BMS) system.

Pressure Regulators

Pressure regulators for individual service lines shall be capable of reducing distribution line pressure to pressures required for users. Ferrous bodies. Pressure relief shall be set at a lower pressure than would cause unsafe operation of any connected user. Gas valve shall be installed immediately upstream of each pressure regulator and regulator shall have a single port with orifice diameter no greater than that recommended by manufacturer for the maximum gas pressure at the regulator inlet. Regulator vent valve shall be of resilient materials designed to withstand flow conditions when pressed against valve port. Regulator shall be capable of limiting build-up of pressure under no-flow conditions to 50 percent or less of the discharge pressure maintained under flow conditions. Contractor shall be responsible for the flow and lockup test.

Anodes

Anodes shall be high potential magnesium alloy, factory packed in cloth bag or box containing prepared packing backfill mixture, and lead wires. Backfill materials shall be hydrated gypsum, bentonite, and sodium sulfate. Approximate magnesium alloy weight, 20 pounds, centered in packing, total weight approximately 45 pounds.

Test Stations

Test stations shall be weatherproof, located at grade, or aboveground. Enclosed terminals for anode leads, test leads, and leads attached to protected system. Connection points for test instruments. The housing unit shall be of standard design, manufactured for use as a cathodic protection test station, complete

Section
Number

Title

with locking cover, terminal board, shunts, and brass hardware. The terminal board shall be removable for easy access to wires and constructed of high impact resistant plastic. Provide means to anchor housing below grade. Test station covers shall consist of manufactured integral yellow color.

Cable Connections

Cable Connectors between cables and pipes, casings or structures shall be exothermic fusion welding process using copper oxide, aluminum and vanadium welding material in graphite molds. Connections between cables and between cables and leads shall be corrosion-resistant split bolts. Insulation of cable to cable connections shall be epoxy resin splice kits with two part resin, mold, sealing mastic.

Where underground valve boxes or utility access boxes are installed with 2 feet of sidewalks, they shall be 1 inch below top of finished sidewalk to accommodate snow removal with damage to boxes or lids.

Where underground valve boxes or utility access boxes are installed in sidewalks, patios, concrete steps, or any other structure where snow removal shall occur, the top of the boxes shall be a minimum of ¼" and a maximum of ½" below finished surface of concrete to accommodate for snow removal without damage to boxes or lids.

Part 3 – Execution

Prior to the start of construction, the Contractor shall hold a pre-construction meeting with the Owner (Project Manager, Plumbing and Natural Gas Department) and the Design Professional. The meeting shall be attended by the gas system installers and shall review the installation and testing requirements for the installation of the gas system.

In order to energize Natural Gas to a building the Contractor must have G8 on the FS#15 signed, and an approved FS#15A for B1-B3 and C6 for the water system.

Special Submittal and Approvals

The Contractor shall submit all data on all materials, welding procedures, welding certifications, shutdown procedures and construction procedures as a package. This submittal will be reviewed by Owner and the DP. Upon approval by Owner and the DP, the submittal shall be sent by the Owner (Master Meter Operator) to the Arizona Corporation Commission (ACC). The review by the ACC

Section
Number Title

shall take a minimum of 30 days. No work shall be started until approval is obtained from the ACC.

The welder's certification, shall be API-1104, and shall be current under the procedure proposed within the six months of the gas system construction.

The Contractor shall request through the Owner, all inspections required by the ACC. The schedule of the inspection is at the discretion of the ACC inspector. The ACC representative shall witness and/or performed visual inspection, including all pressure tests, pipe installation, bedding and shading operations, coating of pipes, installation and testing of cathodic protection systems, tracer wires and meter sets. No work shall be covered until the ACC has been notified, performed their inspection, and the Owner approves covering the work.

Trenching

All underground pipes shall be bedded and shaded with clean cinder sand and install at a depth to provide the minimum cover above the pipe. Shading shall be paced around the pipe, avoiding damage to the pipe coating. Install tracer wire along the top of the pipe and install marking tape at a minimum of 12-inches and a maximum of 18-inch below grade. The minimum depth of cover, measured from top of pipe, shall be as follows;

Gas Mains: 30-inches.
Service Lines: 24-inches.

Piping

Gas distribution system and equipment shall be installed in accordance with the manufacturer’s recommendations and applicable sections of ANSI B31.8 and CFR Title 49, Part 192 - Minimum Federal Safety Standards.

All welding shall be done by welders certified for the type and size of the required welds on natural gas systems. All welding shall conform to CFR Title 49, Part 192.225. Certification of welders shall comply with CFR Title 49, Part 192.227. Welding shall be per the approved welding procedures.

The Contractor shall hire an Independent Testing Agency to inspect and test welds in accordance with CFR Title 19, Part 192.241, and pay all costs of the inspection and testing.

Separation between gas lines and other utilities and structures shall be in accordance with the ACC Rules and regulations. In no case shall the separation be less than 12-inches minimum from utilities lines or structures.

Section
Number

Title

The gas lines shall be as short and as straight as practicable between the point of connections to the existing gas main and shall not be bent or curved laterally unless necessary to avoid obstructions and permitted by the Owner. Gas lines shall be laid with as few as joints as practicable using standard lengths of pipe.

Make service connections at the top of the main, whenever the depth of the main is sufficient to allow top connections. When service connections cannot be made at the top of the main, they shall be made on the side of the main as close to the top as possible. Service connections shall not be made lower than the horizontal midpoint of the gas main.

Taps on the Existing system shall be welded construction, with flanged, full port, round opening, tapping valves. Tap and valve shall be pressure tested prior to cutting the existing pipe.

Schedule and coordinate with the Owner's Gas Shop and the City of Flagstaff Fire Department when working on live gas lines.

Purging of Gas Lines

It shall be the responsibility of the Contractor to purge lines in accordance with the rules and regulations of the ACC. Lines shall be purged with nitrogen. Lines shall be purged in such a way as to prevent the flow of natural gas into building, structure or to other ignition sources. All purges shall be coordinated with and supervised by the Owner's Gas Department.

Cathodic Protection

Install system per the National Association of Corrosion Engineers (NACE) International standards.

Anodes shall be place anodes into augured holes by grasping the cloth gathered at top of packaged anode. Replace ruptured anode packages with undamaged ones. Under no circumstances lower anode into hole by lead wire alone. Presoak packaged anodes in water for at least 15 minutes prior to installation. Tamp screened soil around anode to insure contact between anode and native earth. Provide adequate slack in the lead wire to preclude tearing lead wire loose during backfilling and compacting procedures. Locate anodes so that minimum distance of 36 inches is maintained between anode and gas line to which it is to be attached.

Connect lead wire to piping by using the thermite welding process.

Section
Number

Title

Provide one test station for each eight (8) anodes or 500 feet of piping to permit testing for performance of the cathodic protection system. Use a minimum of No. 12 stranded copper wire and termite welding process.

Testing of the cathodic protection system shall be per the National Association of Corrosion Engineers (NACE) International standards. Tests shall include testing of anodes prior to connecting anode lead wire to the piping and final testing of the cathodic protection system, including measuring pipe-to-soil potentials over the entire system. Make potential measurements with potentiometer voltmeter (minimum internal resistance of 50,000 ohms per volt) and a copper/copper sulfate reference electrode placed at the finished grade level and directly over the pipe. Adequate number of measurements shall be taken over the extent of piping to insure that a minimum potential value of negative 0.85 (-0.85) volts exist over all new gas piping. Upon completion of testing, a report setting forth potential values acquired by location shall be submitted to the Owner.

Pipeline Testing

The Contractor shall test all gas lines in accordance with NFPA 54, ANSI B31.8, and CFR 192.509 and 192.511.

All gas lines shall be tested at 90-PSI, or one and one half (1.5) times the system's design operating pressure, for a minimum period of one (1) hour with no pressure drop.

Holiday testing shall be performed by the Owner's Gas Department until coating deficiencies are corrected.

Sleeves

Pipelines crossing under structures shall be sleeved. Pipe shall be continuous through sleeves. Vent all sleeves to atmosphere and seal between sleeve and the pipe with modular mechanical type seal.

Split sleeves may be installed where existing lines pass under new construction.

Painting

All exposed exterior gas piping shall be painted with acrylic enamel. Color is to be specified by DP and approved by the Owner's PM.

System Abandonment

All abandoned gas line shall be purged and removed by the Contractor. When approved by the Owner (Director of Utilities), abandoned lines may be

Section
Number

Title

abandoned in place. All lines abandoned in place shall be purged, filed with water or nitrogen and capped.

All abandonments and removals shall be noted and dated on the record (as-built) drawings. The Contractor shall submit a written statement to the Owner confirming the date the system was purged, and that purging operations were completed in accordance with all governing regulations.

****END OF SECTION****

Section
Number Title

33 60 00 HYDRONIC AND STEAM ENERGY UTILITIES

33 61 13 Chilled Water Distribution System

Part 1 – General

The Design Professional shall size the piping system based on the design flows and a maximum velocity of 4.5 feet per second. Coordinate with the Project Manager regarding existing flows and pressures within the distribution system and allowances for future expansions of the system.

Valves, install valves on three sides of all tees and four sides of all crosses. Maximum spacing between valves shall not exceed 300 feet.

Part 2 – Products

Polyvinyl Chloride (PVC) Pipe

Polyvinyl Chloride (PVC) Pipe: PVC pipe 4-inch diameter to 12” diameter shall conform to AWWA C900, Class 200 (SDR 14), PVC pipe 12-inch diameter and larger shall conform to AWWA C905, Class 210 (SDR 18), cast iron outside diameter. Elastomeric gaskets shall conform to ASTM F477 providing a water tight seal when tested in accordance with ASTM D3139.

Fittings used on PVC pipe shall be mechanical joint ductile iron (DI) fittings as specified below.

Ductile Iron Pipe (DIP)

Ductile Iron Pipe (DIP): All pipes shall be push-on Tyton joint, mechanical joint (MJ) joint or integral restrained joint ductile iron pipe. The pipe shall be manufactured and tested in accordance with the American Water Works Association (AWWA) Standard C151, and have working pressure (pressure class) of not less than:

4”-12” diameter	Pressure Class 350
16” diameter	Pressure Class 250

Rubber gasket joints shall satisfy requirements of AWWA C111.

Flanged ductile iron pipe shall be manufactured in accordance with AWWA C115, with Class 150 flanges. The minimum thickness class for ductile iron pipe to be

Section Number	Title
-------------------	-------

threaded shall be thickness Class 53. Threads for threaded flanged pipe shall be taper pipe threads in accordance with ANSI B2.1, with thread diameters adjusted to conform to ductile iron pipe standard outside diameters.

All ductile iron pipes shall have a standard thickness cement-mortar lining followed by a seal coat of asphaltic material in accordance with AWWA C104.

The exterior surfaces of all ductile iron pipe and fittings shall be coated with a bituminous material in accordance with AWWA C151 before shipment.

Ductile Iron Fittings

Fittings and specials shall conform to AWWA C110, AWWA C153, and AWWA C111. Fittings and specials shall be cement-mortar lined in accordance with AWWA C104. Linings shall be standard thickness and seal coated with a bituminous material.

The exterior surfaces of all ductile iron fittings shall be coated with a bituminous material in accordance with AWWA C110.

Control Valves

Gate valves (4" to 12") shall be resilient seated gate valves meeting the requirements of AWWA C509, and Maricopa Association of Governments Uniform Standard Specifications and Details for Public Works Construction Standard Specification No. 630. The valves shall be rated bubble tight at 200 PSI. The exterior and interior shall be coated with a thermo-setting or fusion bonded epoxy coating meeting the requirements of AWWA C550. The dry coating thickness shall not be less than 12 mils. Valves shall have mechanical style connections, except flanged joints may be used on the side of the valve that connects directly to a tee or tapping sleeve. Direct buried valves shall have a 2-inch operating nut.

The direction to open the valve shall be to the left (counter clockwise). Valves shall have a minimum of two (2) turns per inch of diameter.

Valves shall be rate for a minimum working pressure 250 PSI and be tested and certified by the manufacturer as being bubble tight at 200 PSI.

Joint Restraint Devices

All joints, fittings, and valves within the system shall be fully restrained.

Section
Number

Title

Joint restraint devices shall comply with Maricopa Association of Governments Uniform Standard Specifications and Details for Public Works Construction Standard Specification No. 750. Acceptable joint restraint devices include the following, or approved equal:

- Ductile iron fittings mechanical style joints - EBAA Iron Sales, Inc. "Mega Lug" joint restraint. The specific model utilized shall be compatible with the type of pipe (DIP or PVC) connected to the fitting.
- PVC pipe push-on style joints – EBAA Iron Sales Series 1600 or approved equal.
- Ductile iron push-on style joints – EBAA Iron Sales Series 1700 or approved equal.
- Ductile iron pipe Integral joint restraint type - U.S. Pipe "TR Flex" restrained joint pipe and fittings, Pacific States "Thrust Lock" joint system, Griffin Pipe "Snap Lok" joint system, or approved equal.
- The use of gaskets with integral restraint grippers shall not be permitted.

Valve Boxes

Valve box and cover shall consist of a cast iron box and cover and PVC riser. The valve box and cover casting shall be manufactured in conformance with ASTM A48, Class 30B. Cover shall be labeled "CHW" or with no logo.

Where underground valve boxes or utility access boxes are installed within 2 feet of sidewalks, they shall be 1 inch below top of finished sidewalk to accommodate for snow removal without damage to boxes or lids.

Where underground valve boxes or utility access boxes are installed in sidewalks, patios, roadways or any other structure where snow removal shall occur, the top of the boxes shall be a minimum of ¼" and a maximum of ½" below finished surface of concrete to accommodate snow removal without damage to boxes or lids.

Valve stem risers shall comply with Maricopa Association of Governments Uniform Standard Specifications and Details for Public Works Construction Standard Specification No. 610 and as detailed on the plans.

Air Relief Valve Vaults

All cast-in-place concrete shall conform to Maricopa Association of Governments Uniform Standard Specifications and Details for Public Works Construction Standard Specification Section 725, Class "S" (3,000 PSI).

Section Number	Title
-------------------	-------

Reinforcement shall conform to MAG Standard Specification 727, Grade 40.

Pre-cast manhole section shall have an inside diameter indicated on the plans and conform to the requirements of ASTM C478.

The frame and cover shall be 30-inch diameter; traffic rated (HS20), and has a bolted watertight lid.

Air Relief Valves (Manual)

Vacuum and air relief valves shall be of the size shown on the plans. Corporations shall be full opening with O-ring seal and bronze ball and conform to AWWA C800. Taps into ductile iron pipe may be made by direct tapping of the pipe or with a service saddle. Taps into PVC pipe shall be made with a service saddle. Service saddles shall conform to AWWA C800, and be constructed of bronze or epoxy coated ductile iron. Saddles shall have a single or double strap. The outlet of the valve shall be equipped with a gooseneck and stainless steel screen as indicated on the drawings. Copper tubing shall be Type K, ASTM B88.

Polyethylene Encasement (Dip Pipe)

Polyethylene encasement shall conform to AWWA C105. The color of the polyethylene encasement shall be purple.

Mechanical Couplings

Couplings used on ductile iron and PVC C900 pipe shall be ductile iron, solid sleeves with mechanical joints, complying with AWWA C110 and C111 and as specified for ductile iron fittings. Couplings shall be fully restrained.

Tapping Sleeves

All tapping sleeves shall conform to MAG Specification No. 630. Sleeves shall be ductile iron or fabricated from ¼-inch (minimum) ASTM 286 Grade C steel or ASTM A-36 steel. Sleeves shall be factory coated with corrosion resistant epoxy in accordance with AWWA C550. Flange shall be 150 LBS MSS-SP60. Bolts shall be corrosion resistant, high strength, low alloy, per AWWA C-111. Gasket shall be Burna-N or neoprene. Sleeves shall be rated for 250 psi.

Part 3 – Execution

General

Section
Number

Title

PVC pipe shall be installed in accordance with the requirements of AWWA C605, the manufacturer's recommendations and Maricopa Association of Governments Uniform Standard Specifications and Details for Public Works Construction Standard Specification No. 610, and as specified herein.

Minimum depth of cover, measured from top of pipe, 36-inches.

There shall be 12 inches of red cinders above any direct bury chilled water lines.

In order to energize chilled water to a building the Contractor must have U14 and U15 on the FS#15 signed, and an approved FS#15A for B1-B3 and C6 for the water system.

Ductile-Iron Pipe

Install in accordance with the recommended procedures set forth in AWWA C600 and Maricopa Association of Governments Uniform Standard Specifications and Details for Public Works Construction Standard Specification No. 610, and as specified herein.

The maximum allowable joint deflection will be as given in AWWA C600. If the alignment required deflection in excess of the above limitations, a sufficient number of fittings shall be utilized to provide angular deflections within the limits set forth. Do not bend or deflect the pipe.

Install all joint restraint devices in accordance with the manufacturer's instructions and prior to pressure testing of the system.

All joints, fittings, and valves within the system shall be fully restrained.

Install all valves in accordance with the manufacturer's instructions. When the top of the operating nut is 4 feet or greater below finish grade, install a valve nut extension as detailed on the drawings.

Install air relief valves at high points. Tap ductile iron or PVC pipe at the high point and install a corporation stop or service saddle and corporation stop. Install copper blow-off line at an upward slope to the air relief valve. Install isolation stop in a location that it is accessible from within the vault.

Attach locator wire to the top of the all chilled water line. The Contractor shall minimize the number of splices in the wire. All splices shall be made with a watertight gland.

Section
Number

Title

Separation Between Chilled Water Lines and Potable Water Lines

The minimum separation between chilled water mains and potable water mains shall be two (2) feet vertically, with the water main above the chilled water main, and six (6) feet horizontally, unless extra protection is provided. In no case shall the chilled water main be placed within one (1) foot vertical or horizontal of a potable water main.

Extra protection shall be mechanical joint ductile iron pipe, restrained joint push-on ductile iron pipe, or concrete encasement of the pipe within a minimum of 6-inches of concrete on all sides of the pipe of the pipe.

Where chilled water mains crosses above or less than two (2) feet below a water main, or within 6-feet horizontally of a water main, the chilled water main shall be constructed of mechanical joint ductile iron pipe for a distance of ten (10) feet on either side of the water main crossing, or when approved by the Owner, both the chilled water and the water main shall be concrete encased.

The horizontal and the vertical dimensions shall be measured from outside of pipe to outside of pipe.

Concrete Encasement

The Contractor shall coordinate with the Owner if the existing main can be depressurized during concrete encasement work. The Contractor shall adjust their schedule to correspond with the approved shut down period. In the event that the existing system cannot be depressurized, the Contractor shall construct the encasement in segments that allows the system to remain in service.

Prior to placing the concrete the existing joints in the existing system shall be exposed and inspected under system pressure. Any leaks or damage to the existing pipe shall be repaired prior to placing concrete.

The Contractor shall install all required temporary supports required to support the existing piping while excavating around the pipe. If the existing pipe is deflected or damaged during construction, all damage piping shall be replaced by the Contractor.

Interior Inspection

Section
Number

Title

Inspect the interior of pipe, fittings and valves prior to installation. Damage pipe, fittings and valves shall not be installed or repaired to the satisfaction of the Owner prior to installation.

Inspection, Examination and Testing

Inspection and examination will be in accordance with ASME B31.9 except as follows:

- This section is applicable for C900 or equivalent only. All other piping is to follow section 33 63 13 requirements.
- All welds and connections are subject to visual inspection for compliance with specifications. Contractors shall be responsible for all labor, material and travel expenses involved in the re-inspection and re-testing of any welds deemed unacceptable. In addition, the Contractor shall be responsible for the costs involved in any and all additional testing required or recommended by ASME/ANSI Standards B31.9 and B31.3 due to the discover of poor, unacceptable or rejected connections.

Leak Testing

- Contractor shall be responsible for all equipment and material necessary to perform leak testing.
- The test equipment shall be examined before pressure is applied to ensure that is tightly connected. All low-pressure filling lines and all other items not subject to the test pressure shall be disconnected or isolated by valves or other suitable means. All test gauges shall be examined to ensure calibrations are current.
- Pneumatic testing may only be used if approved in writing by Owner (Central Plant Supervisor) prior to inspection request.
- Pressures shall be continuously maintained for a minimum time of 2 ½ hours and held for such time as may be necessary to conduct the examinations for leakage. The 2 ½ hour test will not eliminate the requirement to conduct a visual examination of the entire piping system being tested.
- Any initial service leak tests may be allowed according to ASME 31.9 but must be approved in writing by the Owner (Central Plant Supervisor).
- When performing an initial service test, the piping system shall be gradually brought up to normal operating pressure and continuously held for a minimum time of 10 minutes. Examination for leakage shall be made of all joints and connections. The piping system exclusive of

Section
Number Title

possible localized instances at pump or valve packing shall show no visual evidence of weeping or leaking.

Filling System

The pipe shall be filled with potable water, not from the chilled water system.

Hydrostatic Testing

Hydrostatic testing shall conform to AWWA C600 / C605 at a test pressure of 200 PSI, modified as follows:

Allowable Leakage Determination

During the 2 hour, 200 PSI pressure test, the makeup water to maintain the test pressure within 5 psi of the test pressure and re-pressurize the system to the starting pressure shall be measured. Leakage is defined as the quantity of water to be supplied into the newly laid pipe, or approved section thereof, necessary to maintain the specified leakage test pressure after the pipe has been filled with water and the air expelled. No piping installation will be accepted until the leakage is less than the number of gallons per hour as determined by the formula:

$$L = 0.00013 * N * D * (P \text{ raised to } 1/2 \text{ power})$$

In which L equals the allowable leakage in gallons per hour; N is the number of joints in the length of pipeline tested; D is the nominal diameter of the pipe in inches; and P is the average test pressure during the leakage test, in psi gauge. Should any test of pipe disclose leakage greater than that specified in the foregoing table, the defective joints shall be located and repaired until the leakage is within the specified allowance, without additional cost to the Owner.

The Contractor shall provide certified test pressure gauges, calibrated within 8 months of the test. The gauges shall be a minimum of 4-inches in diameter, with a 1 psi scale.

After installation of the sleeve and valve and prior to making the tap, the sleeve shall be tested at 200 psi for 2 hours. There shall be no pressure drop during the test period.

Cleaning and Flushing

C900 or equivalent only, if black iron is to be used, follow the same procedures as Steam, Condensate, and HTHW Distribution Pipe in section 33 63 13.

Section
Number

Title

Contractor shall provide all equipment and material necessary to perform cleaning and passivation of the piping system, sampling of treatment water, and testing of water during treatment.

Test gauges shall be located in a manner that provides easy access and a clear view to the inspector.

Flushing Process:

Remove any filters in the system

Flush pipe for a minimum of 6 hours or until discharge shows no sign of contaminants using a clean bucket to examine discharge (bucket test).

Following the flush, the Contractor will depressurize line and if line is not to be used to convey water or it will be more than 2 weeks before system is brought online, drain as much water as possible. If line is to be brought online within 2 weeks and will convey water, then line may be left filled (Owner may specify a pressure to leave the line at).

System Connections

Unless specifically approved by the Owner in writing, connections to the existing system shall be made only after all pipes have been cleaned and all hydrostatic testing have been approved by the Owner.

33 61 33

Hydronic Energy Distribution Metering

Chilled and Heating Water Meters

All items necessary to allow the chilled water flow sensors to function as energy meters shall be specified and shown on the drawings and included in installation details.

Output of energy meter shall be in BTU's and totalized in MBTU's.

These necessary items shall include, but are not limited to, temperature sensors, BTU totalizing computer, connection requirements to the campus EMS system, programming requirements and software.

Delta temperature transmitters shall be platinum 1000 OHM RTD, where 1000 ohms equals 32^o F.

Section
Number

Title

Delta temperature sensors shall be matched pairs of calibrated sensors with an accuracy of 0.12° F.

Flow transducers shall be selected for the expected flow range encountered at present design conditions, pipe size and material. Particular attention shall be made to design minimum flow conditions.

For all installations an energy totalizing computer will be required.

Products

Owner has pre-approved the following to be in compliance with these standards: Insertible Magnetic Flow Meter- Onicon F3500 with Onicon Series 10 Totalizer.

Steam Meters

All items necessary to allow the steam flow sensors to be fully functional shall be specified and shown on the drawings and included in installation details.

These necessary items shall include, but are not limited to, flow (in lb/hr) totalizing computer, connection requirements to the campus EMS, programming requirements and software.

Temperature transmitters shall be platinum 1000 OHM RTD, where 1000 ohms equals 320 °F.

Flow transducers shall be selected for the expected flow range encountered at present design conditions, pipe size and material. Particular attention shall be made to minimum flow conditions.

For all installations an energy totalizing computer will be required.

Products

Owner has pre-approved the following to be in compliance with these standards: Insertion type vortex meter Onicon F2500 with Onicon Series 2500 totalizer

Part 3 - Execution

Meter EMS Displays: Displays within the EMS for meters shall include the following when applicable:

- HTHW: flow in GPM, energy flow in BTU/hr, totalized energy in BTU's, maximum and minimum instantaneous GPM and BTU/hr with the date and

Section
Number Title

time that point was reached.

- Steam: Flow BTU/hr, totalized energy in BTU’s, pressure in psi, maximum and minimum BTU/hr with the date and time that point was reached.
- Chilled Water: Flow in GPM, energy flow in BTU/hr, totalized energy in BTU’s, maximum and minimum GPM, BTU/hr and peak load in tons with the date and time that point was reached.
- All maximum and minimum values shall have a button to reset when those values were tracked from. Multiple meters may be required to record maximum and minimum flows. Trends on flow rate and totalized energy must be setup within the EMS prior to substantial completion.

33 63 13 Steam and HTHW Distribution System

Part 1 – General

This section includes the general requirements for Steam and High Temperature Hot Water Distribution Systems (HTHW) up to a buildings heat exchanger. High pressure steam and condensate pipe, fittings, valves, insulation and accessories shall be in accordance with Division 23. High temperature hot water pipe, fittings, valves insulation and accessories with Division 23.

In order to energize steam or HTHW to a building the Contractor must have U11, U12 and U13 on the FS#15 signed, and an approved FS#15A for B1-B3 and C6 for the water system.

Part 3 – Execution

Inspection Examination and Testing

Inspection and Examination will be in accordance with ASME B31.9 except as follows:

All welds are subject to visual inspection and a minimum 10% by x-ray, for compliance with specifications. The Owner will, at the Owner’s option, provide a 3rd party testing company for the purposes of performing said x-ray testing. Initial visual and x-ray inspections will be provided by the Owner. Contractor shall be responsible for all labor, material and travel expenses involved in the re-inspection and re-testing of any welds deemed unacceptable. If more than 50% of x-ray inspected welds fail than all welds will be x-ray inspected at the Contractor’s cost. In addition, Contractor shall be responsible for the costs involved in any and all additional testing required or recommended by ASME/ANSI Standards B31.9 and B31.3 due to the discovery of poor, unacceptable, or rejected welds.

Section
Number

Title

Boiler external piping (all pipe upstream of the second isolation valve prior to connecting to the steam main_ shall be hydrostatically tested in accordance with the ASME Boiler and Pressure Vessel Code. The test shall be conducted in the presence of a National Board of Boiler Inspectors certified inspector.

Leak Testing

Contractor shall be responsible for all equipment and material necessary to perform leak testing.

The test equipment shall be examined before pressure is applied to ensure that it is tightly connected. All low-pressure filling lines and all other items not subject to the test pressure shall be disconnected or isolated by valves or other suitable means. All test gauges will be examined to ensure calibrations are current.

Pneumatic testing may only be used if approved in writing by Owner's Central Plant Supervisor prior to inspection request.

Pressures shall be continuously maintained for a minimum of 2 ½ hours and held for such time as may be necessary to conduct the examinations for leakage. The 2 ½ hour test will not eliminate the requirement to conduct a visual examination of the entire piping system being tested.

Any initial service leak tests may be allowed according to ASME 31.9 but must be approved in writing by the Owner's Central Plant Supervisor.

When performing an initial service test, the piping system shall be gradually brought up to normal operating pressure and continuously held for a minimum time of 10 minutes. Examination for leakage shall be made of all joints and connections. The piping system exclusive of possible localized instances at pump or valve packing shall show no visual evidence of weeping or leaking.

Cleaning and Flushing

Contractor shall provide all equipment and material to perform cleaning and passivation of the piping system, sampling of treatment water, and testing of water during treatment. Water samples will be taken to the Central Plants for testing. The chemicals listed are based on material provided by the Owner's Chemical Treatment Representative. Contractors may contact Owner's Chemical

Treatment Representative to purchase chemicals at the Owner rate.

Section
Number

Title

Test gauges shall be located in a manner that provides easy access and a clear view to the inspector.

Flushing Process

Remove any filters in the system.

Flush pipe for a minimum of 6 hours or until discharge shows no sign of contaminants using a clean bucket to examine discharge (bucket test).

Drain system.

Refill with fresh water adding 1% of Ferroquest FQ7101 based on the volume of water in the system. (ex. 100 gallons of FQ7101 would retreat 10,000 gallons of system water).

Note: The conductivity will be ~2000 micromhos higher than the starting conductivity.

Take an initial water sample and check conductivity and pH. Record and retain sample.

As the pH increases during the cleaning, maintain the pH at 6.2 – 6.8 with Ferroquest FQ7102. One gallon/1000 gallons of system volume will drop the pH approximately 0.2 pH units.

Check water sample 3 times per day for pH add Ferroquest FQ7102 as needed to maintain the pH in correct range. Record pH and retain samples.

Circulate the cleaning solutions for 3 days. Maintain water temperature between 100° F and 120° F. Do not exceed 140° F. Prior approval from Owner is required if the temperatures cannot be maintained.

Take water sample before draining and retain.

Samples will be provided to the Owner's Central Plant Supervisor and then sent for lab analysis. Results to be provided to Owner's Project Manager and Contractor shall be responsible for cleaning.

Section
Number

Title

Flush the pipe and perform a bucket test. Flushing will be required until the conductivity is near that of the city water sample. Sample throughout the flushing and record conductivity and retain samples. Owner's Central Plant staff will be responsible to determine when flushing is complete by review of flushing record and sample.

Following the flush, Contractor shall depressurize line and if line is not to be used to convey water or it will be more than 2 weeks before system is brought online, drain as much water as possible. If line is to be brought online within 2 weeks and will convey water, than line may be left filled (Owner may specify a pressure to leave the line at).

33 63 20

Steam and High Temperature Hot Water Tunnels

Part 1 – General

This Section includes the general requirements for utility tunnels and vaults utilized for the campus steam and high temperature hot water distribution systems.

Tunnel and vaults may be precast concrete, cast in place concrete, large diameter pipe conduits, or composite pipe and concrete encasement.

Structural loading, tunnels shall be designed to be capable for supporting the following loads:

Live Loads shall be in accordance with one of the following American Association of State Highway and Transportation Officials (AASHTO) standards:

AASHTO "Standard Specifications for Highway Bridges". Structures under pedestrian areas, landscape areas, drives and parking lots shall be designed for HS20 truck loading (32 KIP axle load). Tunnels under principal roadways shall designed for the critical controlling loading condition of HS20 or the alternative military/interstate loading (two 24 KIP axle loads, 4 feet apart), in either single or passing mode.

AASHTO "LRFD (Load and Resistance Factor Design) Bridge Design Specifications". Structures under pedestrian areas, landscape areas, drives and parking lots shall be designed for HL93 truck loading (32 KIP axle load). Tunnels under principal roadways shall be designed for the critical controlling loading

Section
Number

Title

condition of HL93 truck loading or the design tandem load (two 25 KIP axle loads, 4 feet apart). "Lane loads" may be omitted from the loading calculations.

Impact Factor, per AASHTO standards.

Dead loads shall use a minimum soil density of 120 pounds per cubic feet.

Hydrostatic pressure, the design shall consider that excavation in rock or other low permeable soils may result in the backfill around the tunnel being a flow path for infiltrated stormwater. The design shall consider both the existing soil condition as well as all modifications that may result from the construction.

Pipe and equipment load shall be based on design piping configuration. Walking tunnels shall also include a 50 percent allowance for future piping and equipment.

Anchor and thrust restraint loads shall be based on the piping design. In walking tunnels there shall be anchor provisions at each deflection point of the tunnel and at vaults.

Tunnel Configuration

Type A tunnels shall be designed to accommodate the piping systems and provide maintenance access through the tunnel system as indicated in Figure 1 and Figure 2.

Piping systems may be orientated along one or both sides of the tunnel.

Maintenance access area shall be a continuous clear area, a minimum of 2'-6" wide by 6'-0" tall. Circular configurations shall have a concrete infill to provide a level walking surface.

Type B tunnels may be designed to only accommodate the piping systems, refer to Figure 3.

The lid or roof of the tunnel shall be removable to accommodate maintenance access. Do not attach pipes, hangers, or supports to the lid or roof.

Section
Number Title

Mechanical equipment such as expansion joints, ball joints, etc within Type B tunnels shall be located under a hatch that provides maintenance access without the removal of the tunnel lid or roof.

Steam tunnels longer than 150 feet in length, and all steam tunnels that will ultimately provide steam distribution to more than two (2) buildings shall be Type A.

Steam tunnels less than 150 feet in length and will ultimately provide steam distribution to two (2) or less buildings, may be Type A or Type B.

High temperature hot water tunnels may be Type A or Type B.

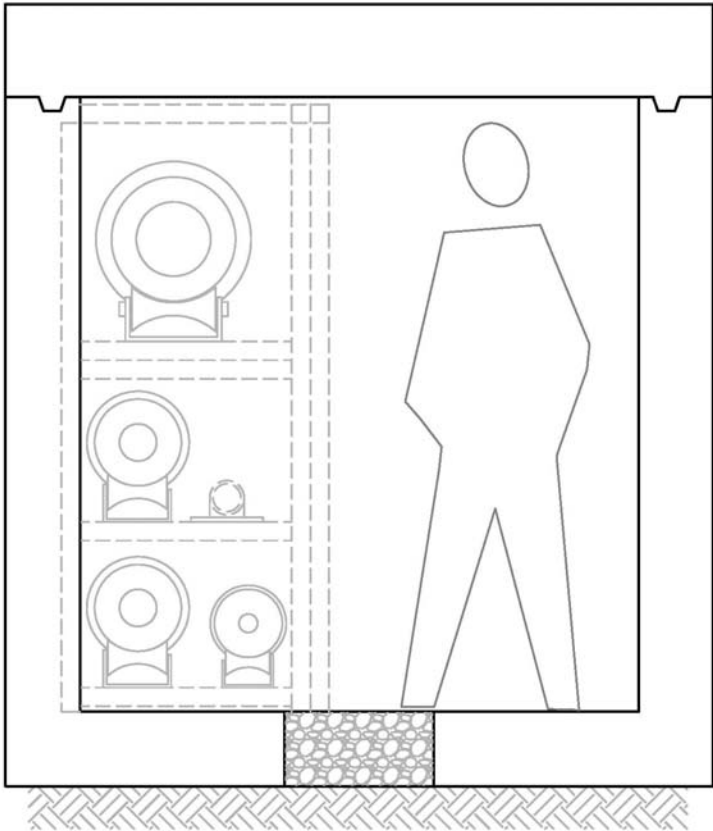

Figure 1 – Type A Tunnel – Rectangular Cross Section

Section
Number Title

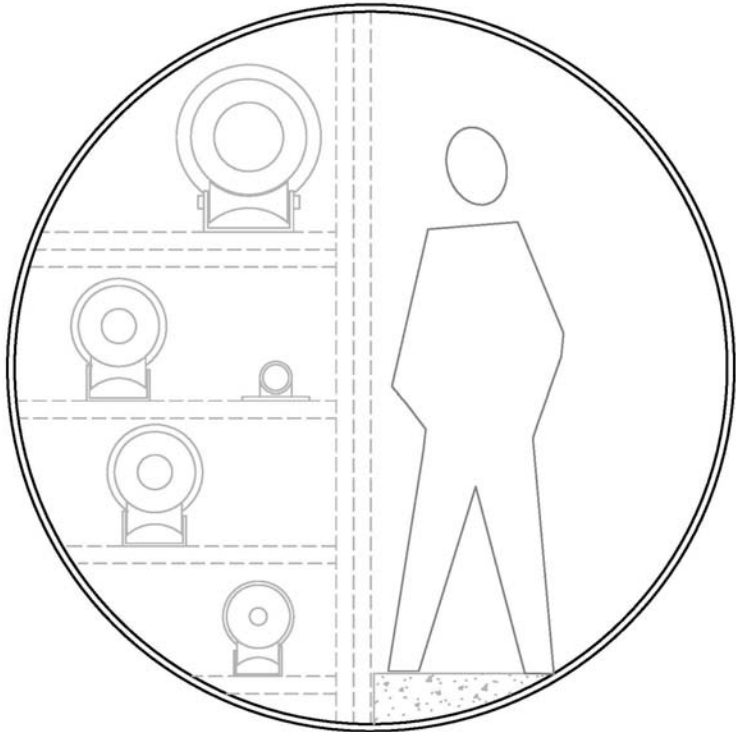
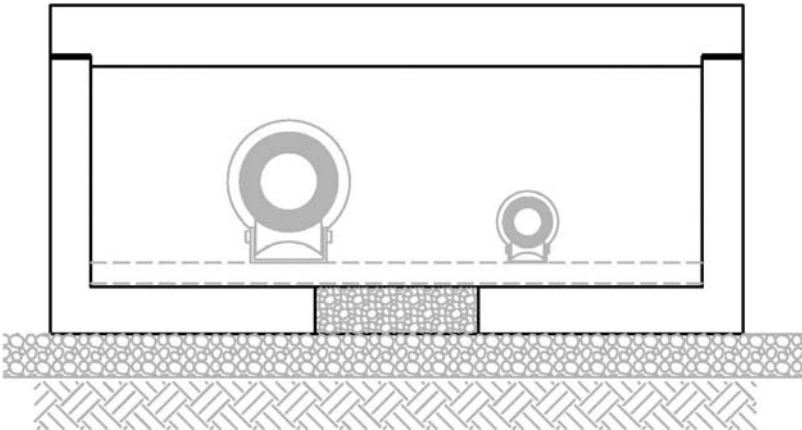

Figure 2 – Type A Tunnel – Circular Cross Section



Section
Number

Title

Figure 3 – Type B Tunnel Cross Section

Vault shall be located at all junctions and service line connections.

Tunnels shall be water tight. Type A Tunnels may have a gravel floor, or drain sumps. Install sump pumps in low areas.

Ventilation of Type A tunnels and all vaults shall be in accordance with OSHA requirements.

Lighting shall be provided in all Type A tunnels in accordance with OSHA requirements. Avoid installing light above the access corridor that would impede access. Lighting circuits shall be switch at each access point in the tunnel system. Use toggle switches to control lighting circuits.

In Type A tunnels provide 20 amp, 120 volt electrical receptacles at 200 foot spacing for use by maintenance crews.

Grade of tunnel shall be in accordance with the requirements of the piping systems.

Provide all embeds, anchors, and accessories indicated on the drawings, and required to install the utility lines within the tunnel.

Part 2 – Products

Cast-in-place Concrete Tunnels

Cast in placed concrete tunnels shall be designed in accordance with the International Building Code (IBC) and ASCE 7 – Minimum Design Load for buildings and Other Structures.

Precast concrete tunnels

Design Criteria - Design units in accordance with:

Section
Number

Title

ACI 304 and 318.

CRSI Manual of Standard Practice.

Applicable ASTM Standard(s).

Concrete: Concrete shall be a uniform mix of quality materials shall be determined by following the standards in ACI 318 Chapter 5. Recommendations for selecting proportions for concrete are given in detail in Standard Practice for Selecting Proportions for Normal, Heavyweight, and Mass Concrete (ACI 211.1). Recommendations for lightweight concrete are given in Standard Practice for selecting proportions for Structural Lightweight Concrete (ACI 211.2).

Water-Cement Ratio: Concrete that will be exposed to freezing and thawing shall contain entrained air and shall have water-cement ratios of 0.45 or less.

Portland Cement: ASTM C150, V.

Aggregates: ASTM C33 or C330.

Water: Potable or free of deleterious substances in amounts harmful to concrete or embedded metals.

Admixtures:

Air-entraining: ASTM C260

Water reducing, retarding, accelerating, high range water reducing: ASTM C494

Pozzolans, fly ash and other mineral admixtures: ASTM C618

Ground granulated blast furnace slag: ASTM C989

Reinforcing Bars:

Deformed Billet-steel: ASTM A615.

Deformed Rail-steel: ASTM A616.

Reinforcing Wire: Plain Wire: ASTM A82.

Section Number	Title
-------------------	-------

Welded Wire Fabric: Plain Wire: ASTM A185.

Precast Fabrication

Forms for manufacturing precast concrete products shall be of the type and design consistent with industry standards. They should be capable of consistently providing uniform products and dimensions. Forms shall be constructed so that the forces and vibrations to which the forms will be subjected can cause no product damage. Forms shall be cleaned of concrete build-up after each use. Form release agents shall not be allowed to build up on the form casting surfaces.

Reinforcement: Cages of reinforcement shall be fabricated either by tying the bars, wires or welded wire fabric into rigid assemblies or by welding where permissible in accordance with AWS D1.4. Reinforcing shall be positioned as specified by the design and so that the concrete cover conforms to requirements. The tolerance on concrete cover shall be one-third of that specified but not more than 1/2 in. Concrete cover shall not be less than 1/2 in. Positive means shall be taken to assure that the reinforcement does not move significantly during the casting operations.

Inserts and Embedded Metal - All items embedded in concrete shall be of the type required for the intended task, and meet the following standards:

Structural steel plates, angles, etc: ASTM A36

Welded studs: AWS D1.1

Finishes: Hot-dipped galvanized: ASTM A152 or Zinc-rich coating: MIL-P-2135 self-curing, one component.

Joint Sealant and Joint Gaskets:

External Sealing Bands for Noncircular Sewer, Storm Drain, and Culvert Pipe: ASTM C877.

Joints for Concrete Pipe, Manholes, and Manufactured Box Sections Using Preformed Flexible Joint Sealants: ASTM C990

Grout:

Section
Number

Title

Cement grout: Portland cement with enough water for the required strength and sand for proper consistency. May contain mineral or chemical admixtures, if approved by Owner's representative.

Non-shrink grout: Premixed, packaged expansive and non-expansive shrink-resistant grout.

Access Hatches

Access doors and hatches shall be aluminum construction, AASHTO HS-20 rated, gasketed, water tight. Door shall have compression spring assist opening mechanism, stainless steel hold open arms with positive locking, heavy duty hinges, lifting handles, and hasp. Doors shall be lockable.

Where utility access hatches are installed within 2 feet of sidewalks, they shall be 1 inch below top of finished sidewalk to accommodate snow removal without damage to boxes or lids.

Where utility access hatches are installed in sidewalks, patios, concrete steps, or any other structure where snow removal shall occur, the top of the access hatches shall be a minimum of ¼" and a maximum of ½" below finished surface of concrete to accommodate for snow removal without damage to boxes or lids.

Ladders

Ladders shall be all aluminum, fully welded construction. Rungs shall be ribbed, slip resistant 1-3/8 inch diameter, spaced on 12 inch centers. Rails shall be 3/8" x 2-1/2" flat bar, spaced 16 inches apart. Mounting brackets shall offset the ladder 7 inches from the wall. Provide telescoping extension rails that extend to 36 inches above the vault when extended.

Part 3 – Execution

General

Cast in place tunnels shall be constructed in accordance with the recommendations of the geotechnical report and ACI standards.

Precast concrete tunnels shall be set on an aggregate base course, leveling pad. Install tunnels true to grade and equipped with all appurtenances required for the piping systems.

Minimum depth of cover, measured from top of tunnel, shall be as follows;

Section
Number Title

Cast-in-place tunnels: 0-inches
Precast tunnels: 12-inches

Embeds

Embedded Items: Embedded items shall be positioned at locations specified in the design documents. Inserts, plates, weldments, lifting devices and other items to be imbedded in precast concrete products shall be held rigidly in place so that they do not move significantly during casting operations.

Placing Concrete

Concrete shall be deposited into forms as near to its final location as practical. The free fall of the concrete shall be kept to a minimum. Concrete shall be consolidated in such a manner that segregation of the concrete is minimized and honeycombed areas are kept to a minimum. Vibrators used to consolidate concrete shall have frequencies and amplitudes sufficient to produce well consolidated concrete.

Cold Weather Requirements: Recommendations for cold weather concreting are given in detail in Cold Weather Concreting reported by ACI Committee 306.

Hot Weather Requirements - Recommendations for hot weather concreting are given in detail in Hot Weather Concreting reported by ACI Committee 305.

Curing

Curing by Moisture Retention - Moisture shall be prevented from evaporating from exposed surfaces until adequate strength for stripping is reached.

Joints

Install water-stops or joint sealants in all joints.

Moisture Protection

Install moisture protection on the top and sidewalls of all cast in place tunnels.
Install sump pumps as required.

****END OF SECTION****

Section
Number Title

33 70 00 ELECTRICAL UTILITIES

In order to energize electricity to a building the Contractor must have U3, U5 and U6 on the FS#15 signed, an approved FS#15A for B1-B3 and C6 for the building and pad mounted switch metering and an approved work authorization.

Any changes to 12.47 kV distribution system, up to and including the transformers, shall require a modification to the campus one line diagram. Owner will provide a CAD file for the existing system. The DP is to include the revised campus one line in the construction drawings and must supply an as built CAD file as part of the closeout. The one line must include all pertinent data including but not limited to: conductor size, conduit size and quantity, switch cabinets with fuse and ct sizes, switch cabinet compartment numbers, transformer sizes and estimated loading, and building numbers that are connected to the transformer.

33 71 00 Electrical Utility Transmission and Distribution

33 71 19 Electrical Underground Ducts and Manholes
Part 1 – General
N/A

Part 2 – Products
Owner has pre-approved the following pullboxes to be in compliance with these standards: Quazite PR style.

Part 3 - Execution

Section
Number

Title

Underground PVC conduits containing cables over 600 volts shall be a minimum of 4" and have a spare conduit for each feeder. The conduit system shall be encased with a 3000psi minimum of 3" of integral-color red concrete slurry (one 50lb bag of dye per cubic yard of concrete or 4% dye if liquid) on all sides of each conduit. Concrete shall be with aggregate small enough to work around conduits. Concrete around duct banks shall be carefully vibrated to prevent voids around and under conduits. Slurry shall not be used as backfill and shall only be used to encase conduits based on shading dimensions outlined in 33 00 00.

Pullboxes shall be round enclosures. Any pullbox located in a sidewalk or roadway shall be traffic rated.

33 71 39

High Voltage Wiring (Above 600-Volt)

Part 1 – General

Owner's primary electrical distribution system is a 12.47kV underground system, installed in ductbank. 12.47KV distribution will not be allowed in the tunnel network. The topology is looped on South Campus, and primary-selective on North Campus. Any modification to the primary distribution system shall maintain the existing topology.

High voltage switchgear shall be box pad mounted, low profile, dead front type, S&C Manufacturer. High voltage switchgear shall be set on box pads per APS standards.

A fault current indicator shall be provided on each cable at the source of each feeder to help operators locate system faults.

All modifications to or extensions of the existing Owner medium-voltage electrical system require the approval of the Owner's Electrical Shop and Director of Utilities at the Schematic Design level.

Part 2 – Products

Medium voltage cable shall be shielded ethylene-propylene-rubber (EPR) insulated, 133% insulation level, copper conductor, as manufactured by Okonite, Kerite, Prysmian, or approved equivalent, with a 40 year warranty.

All cable utilized in a pull shall have been manufactured during the same production run from the factory. All cable on the project shall be new, shall have

Section
Number

Title

been manufactured within 12 months of the date of receipt at the job site, and shall be shipped with original manufacturer's cable end seals. Cable reels shall be shipped and stored with end flanges vertical. Storage of cable prior to installation shall comply with the recommendations of the manufacturer.

Part 3 – Execution

The installing contractor shall have an Arizona high-voltage license. Installing personnel shall be qualified and certified by the manufacturer in the installation and testing of cable, splices, and terminations.

New cables shall be tested after installation by insulation resistance testing and partial discharge testing, or hi-pot testing. Service-aged cables shall be tested after installation by insulation resistance testing and online partial discharge testing.

Testing shall be performed by an independent 3rd-party testing agency; the Design Professional shall coordinate with Owner to properly specify whether Owner or the installing contractor will be responsible for hiring the testing agency.

Insulation-resistance Test: Test all new and service-aged cables with respect to ground and adjacent conductors. Test data shall include megohm readings and leakage current readings. Cable shall not be energized until insulation-resistance test results have been approved by the Owner's Electrical Shop. Test voltage shall be 2,500VDC. Minimum acceptable resistance value shall be 5,000 megohms. Provide a comprehensive report that describes the identification, length, terminations and location of cables tested, the test equipment used, and the date tests were performed; identifies the persons who performed the tests; and identifies the insulation resistance for each cable section tested. The report shall provide conclusions and recommendations for corrective action.

Online Partial Discharge Test: Test all new and service-aged cables. Perform tests after cables have passed the insulation-resistance test, and after successful energization. Testing shall use a time or frequency domain detection process incorporating radio frequency current transformer sensors, with a partial discharge detection range of 10khz to 300Mhz. Provide a comprehensive report that describes the identification and location of cables tested, the test equipment used, and the date tests were performed; identifies the persons who

Section
Number Title

performed the tests; and identifies numerically and graphically the magnitude of partial discharge detected for each cable section tested. The report shall provide conclusions and recommendations for corrective action.

Hi-pot test: Maximum test voltage shall be 55kV, or maximum as allowed by cable manufacturer. Apply voltage in approximately 8 to 10 equal steps. Raise the voltage slowly between steps. At the end of each step, allow 5 minutes for the charging currents to decay. Time and record the interval of decay. Make leakage current readings at 1 minute intervals for each voltage step. Read the leakage current and plot a curve of leakage current versus test voltage on graph paper as the test progresses. Stop the test and replace the cable if leakage currents increase excessively or a “knee” appears in the curve before maximum test voltage is reached. Upon reaching maximum test voltage, hold the voltage for five minutes for fifteen minutes. Read the leakage current at 30 second intervals and plot a curve of leakage current versus time on the same graph paper as the step voltage curve. Stop the test if leakage current starts to rise, or decreases and again starts to rise.

Leakage current should decrease and stabilize for good cable. Terminate test and allow sufficient discharge time before starting the next conductor.

33 71 73 Electrical Utility Services

Part 1 – General

Service Entrance Switchboards shall be provided with ammeter, voltmeter (both with phase switching positions and off positions). Provide kilowatt-hour meter with demand register. Multiplier shall be marked on meter. Label switchboards with CT ratios. KWH meters shall be adaptable to supply a pulse train output for future BMS system.

Part 2 – Products

N/A

Part 3 – Execution

N/A

33 71 73.33 Electric Meters

Part 1 – General

Section
Number

N/A

Part 2 – Products

N/A

Part 3 – Execution

Meter EMS Displays: Displays within the EMS for meters shall include the following when applicable:

- Electric: demand in KW, Totalized in kWh, total voltage, voltage per phase, total amperage, amperage per phase, total power factor, and power factor per phase.

All maximum and minimum values shall have a button to reset when those values were tracked from. Multiple meters may be required to record maximum and minimum flows. Trends on flow rate and totalized energy must be setup within the EMS prior to substantial completion.

33 73 00 Utility Transformers

Part 1 – General

Building service transformers shall be outdoors, located so as to be accessible for maintenance. Transformers shall not be located in basements or other areas subject to contaminant by flood waters. Transformers will be minimum of 6’ from the edge of sidewalks, pedways or roadways.

Provide bollards to protect transformers. The number of bollards will be determined by transformer location.

Transformers shall comply with 2010 US Department of Energy requirements.

Part 2 – Products

Service transformers shall be liquid cooled non-PCB type. Locate at exterior service side of building for accessibility. Aluminum or copper windings are acceptable. Penta head bolts shall be used on transformer door. (Penta had socket to be turned over to Owner when job is complete.)

Box pads shall be pre-manufactured fiberglass type.

kVA	as required for the project
Temperature Rise	65 degree average winding rise

Section Number	Title
	Cooling Class KNAN
	Frequency 60
	Insulating Fluid Envirotemp FR3
	Elevation Designed for operation at 2500 m (8250 ft) above sea level
	Efficiency Standard DOR 2010, 10 CFR Part 431
	Sound Level NEMA TR1 Standard
	Primary Voltage 12470 Delta
	BIL kV as required
	kV Class kV as required
	Primary Configuration Dead Front
	Primary Configuration Loop Feed
	Taps 2 – 2.5% taps above and 2 – 2.5% taps below nominal
	Tap Charger 100 amp 5 position tap changer
	Primary Bushings 200 amp copper bushing well(s) (Qty. 6)
	Load-break Switching 630A four position T-blade switch
	Arresters None
	Overcurrent Protection Bayonet fuse in series with Partial-Range current-limiting fuses
	Explosion Fuses Bayonet fuses
	Bayonet Holder Copper Bayonet Fuse Holder
	Spare Fuses Bayonet Fuses
	Pocket on Compartment Door for Spare Fuses
	Secondary Voltage 480Y/277 or 110/208 as required
	BIL kV as required
	Secondary kV Class kV as required
	Secondary Bushings 5/8" copper stud with 4-hole screw-on spade bushing(s)
	Cabinet 20in deep cabinet
	Cabinet Hardware Penta-head cabinet door bolts
	ANSI K-Dimension Loop feed per ANSI C57.12.34 Figure 2 minimum dimensions
	Notifications Danger High Voltage decals-one on each side of unit
	Notifications DOE Efficiency Compliant Decal
	Gauges & Fittings Liquid Level Gauge
	Gauges & Fittings Thermometer, dial type
	Pressure/vacuum gauge
	Drain valve with sampler in LV Compartment (1")

Section Number	Title
	Schrader valve
	Pressure relief device, 50 SCFM
Tank Accessories	IEEE standard one-hole ground pads (Qty. 3)
	Nitrogen Blanket
Packaging	Pallet
Cover	Bolted Cover

Part 3 – Execution

The concrete pad shall extend 6” beyond transformer footprint on sides and rear, and 36” in front of the transformer. Top of pad shall be 3” above finished grade.

Installation shall be in accordance with the Arizona Public Service (APS) standard details.

Provide bollards to protect switchgear. The number of bollards will be determined by switchgear location.

10’ clearance must be maintained on the door side of the transformer.

33 77 00 Medium – Voltage Switchgear and Protection Devices

Part 1 – General

Each new building shall provide the necessary loop-feed box pad mounted switchgear (South Campus) or primary-selective box pad mounted switchgear (North Campus), and transformer(s) for its connected load. Switchgear will be minimum of 6’ from the edge of sidewalks, pedways or roadways.

Provide spare primary fuses for each conduit installed.

The Design Professional shall use the Arizona Public Service (APS) standard details for installing switchgear, and shall include the appropriate details on the drawings.

New or refurbished medium voltage box pad mounted switchgear shall be provided with integral bus voltage metering and switch position monitors which shall report to the central metering system.

Part 2 – Products

Section
Number Title

Medium voltage switchgear shall be box pad mounted, low profile, deadfront type, as manufactured by S&C, or approved equal. All fuses shall be S&C SMU-20 with SME-20 fuse holders. Oil filled switches shall not be accepted.

Box pads shall be pre-manufactured fiberglass type.

Part 3 – Execution

Top of pad shall be 3” above finished grade.

Installation shall be in accordance with the Arizona Public Service (APS) standard details.

Provide bollards to protect switchgear. The number of bollards will be determined by switchgear location.

10’ clearance must be maintained on the door sides of the switch. 6’ of clearance for the other sides.

****END OF SECTION****

Section
Number

Title

33 80 00 COMMUNICATION UTILITIES

33 81 00 Communication Structures

Any communication system installed in the tunnels shall be in inner-duct and secured to the tunnel wall so it is not in conflict with other utilities or means of egress from the tunnels. Inner-duct shall be supported no less than every six-feet on center. Sag of the inner-duct between supports shall be no more than 2 inches at mid-span.

33 81 26 Communications Underground Ducts, Manholes, and Handholes

Owner's communication pathway infrastructure consists of utility tunnel and conduit pathways connecting all campus buildings to three main switching nodes. All pathways and spaces to conform to TIA/EIA-758 standard. The Design Professional shall specify the following site development requirements:

- Minimum of two 4 inch conduits for building entrance cable. Larger complexes may need more. One complete spare must be available after cable is installed. Pull string in place in spare conduit.
- Minimum of one 4 inch conduit populated with two (2) packs of 4" 3 cell Maxcell Sleeves or three (3) packs of 3" 3 cell Maxcell sleeve minimum. One pack shall be detectable. Once the Maxcell is installed, verification by installation of replacement pull line (1200lb line minimum) in all sleeves shall be performed. Each Maxcell sleeve shall be color coded independently from each other. Consult with Owner (ITS) prior
- All conduits shall be buried at a minimum depth of 36".
- Minimum one (1) Maxcell sleeve shall be equipped with tracer wire.
- Conduit construction to be minimum schedule 40 rigid non-metallic.
- All conduit runs designed with drainage slope towards the manhole/vault and maximum of two 90° bends. All bends encased in concrete.
- The section length shall not exceed 600 ft between pulling points.
- When a joint trench method is used the following vertical and horizontal separations between telecommunications facilities and other facilities shall be maintained.
- All vaults/manholes shall be equipped with copper or copper clad grounding rod with .3 resistance to ground maximum.

Section
Number

Title

- All vaults/ manholes shall be placed on a minimum 12" bed of washed clean gravel and extending 12" minimum from the exterior walls of the vault/ manhole.
- All conduits entering the vault/ manhole shall be set minimum 8" above finished floor/ ground.
- All conduit duct banks shall be labeled inside the vault or manhole with the destination of the conduit bank
- All manholes shall have the ID of the manhole labeled on the inside of the vault or manhole and on the manhole lid/cover. Manhole lid/cover shall be labeled with a stamp or engraved, or a manufacturer label. No welding.

ADJACENT STRUCTURE

MINIMUM SEPARATION

Power or other foreign conduit

3 inches of concrete
 OR
 4 inches of Masonry
 OR
 12 inches of earth

Pipes (gas, oil, water, etc.)

6 inches crossing
 OR
 12 inches when parallel

It is the Owner’s preference that there are no manholes or handholes in the pathway design. However if access points are necessary minimum requirements are as follows:

- 4'x 8'x4' with cover providing full access to entire space
- All access points will be equipped with cable racking. Pulling eyes and sump
- Conduits should enter and exit from end walls of access point
- All penetrations in maintenance holes shall be sealed in the maintenance holes and in the building with a reenter-able type solution approved by Owner (ITS). Rigid foams are not permitted.

Section Number Title

Typical Manhole

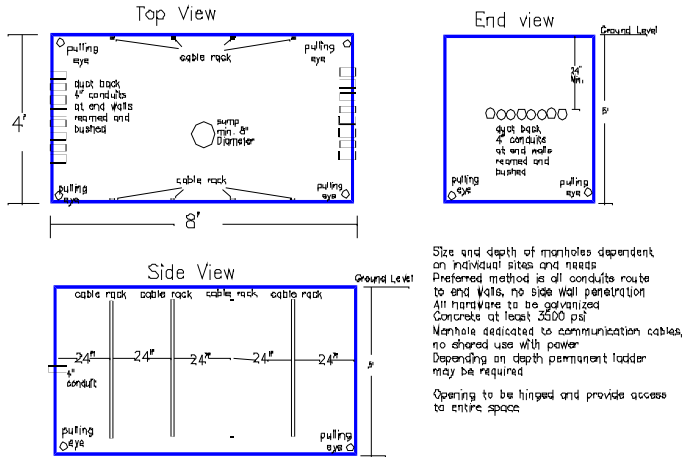

33 82 00 Communications Distribution

The Owner’s communication system is based on a passive ring architecture with three switching centers located in building 24, building 54 and building 64. All copper and optical fiber backbone cabling shall be routed to the appropriate switching center. All distribution design is the responsibility of Owner (ITS) and the installation is the responsibility of the Contractor. All Owner buildings shall be fed with twisted pair copper (number of pairs determined by Owner on a per project), minimum of 24 strands of multi-mode optical fiber and minimum of 48 strands of single-mode optical fiber. Special applications may require more fiber strands.

33 82 01 Switching Center Terminations

Building 24 terminate twisted pair on Circa 1900-100K Series Stub in/out 100pr. BETs with cover units with gas modules. Building 54 terminate twisted pair on Circa 1900-100K Series Stub in/out 100pr. BETs with cover units with gas modules and 25 pair cables terminated on Rack Mount 110 blocks with cable management and C5’s. Building 64 terminate twisted pair on Circa 1900-100K

Section Number	Title
	Series Stub in/out 100pr. BETs with cover units with gas modules and cables terminated on Rack Mount 110 blocks with cable management and C5's. All optical fiber shall be fusion spliced with keyed LC type connectors.
33 82 13	<p>Copper Communications Distribution Cabling</p> <p>Copper cable shall be PE 39 type and meet the following requirements:</p> <ul style="list-style-type: none"> • Solid annealed, bare copper conductors • Solid polyolefin insulation, color coded to telephone industry standards • Cable core filled with waterproofing compound • Aluminum shield with polyethylene jacket • 24 AWG, pair count determined by Owner per project • Cable shall meet the requirements of ANSI/CEA S-84-608
33 82 23	<p>Optical Fiber Communications Distribution Cabling</p> <p>Cable: Glass fiber, loose tube all dielectric gel filled osp cable rated for duct installation. Multi-mode OM3 50 micron core, 125 micron cladding diameter with MIFL of 3.5db/km & 500 MHz-km @ 850nm, 1.5db/km & 500 MHz-km @1300nm. Single-mode 125-micron cladding diameter with MIFL of 0.4 db/km at 1300nm and 0.3 db/km at 1550nm. Proof tested to 100kpsi.</p> <p>Fiber Distribution Shelf: Modular design with jumper routing guides for vertical and horizontal runs and all associated shelves, panels, interconnection couplers and hardware necessary to terminate all fibers with room for 25% growth.</p> <p>Wall Mount Distribution Units: Metal construction, lockable, capable of splicing and termination in same housing, all hardware necessary to terminate fiber (including cable attachment, connector panels, interconnect couplers, fan-out kits, etc.) All connectors and interconnect couplers must be from same manufacturer.</p> <p>Connectors: Keyed LC compatible with ceramic ferrule. Maximum attenuation of 0.4db and durability of 0.2db after 500 matings. All connectors and interconnect couplers from same manufacturer.</p> <p>Splice cases: Sealed, reenterable closure designed for fiber optic cable. All necessary trays, hardware, grommets, etc. to complete to manufacturer's instructions and specifications. All splices to be fusion, no mechanical splicing.</p>

Section
Number Title

All fibers (inter and intra building) tested for continuity and tagged at both ends with building number and ID number. All fibers tested for insertion loss, both directions, at 850nm and 1350nm on multi-mode, and at 1310nm and 1550nm on single-mode. All results documented. OTDR signature trace on all fibers with pertinent points documented (splice, endpoints, etc.) Only test results with University personnel present will be accepted.

****END OF SECTION****